

**The ecohydrology of the Franschoek Trust Wetland: water, soils and
vegetation.**

Ilse Kotzee

**A thesis submitted in fulfillment of the requirements for the degree of
Magister Scientiae, in the Earth Science Department, University of the
Western Cape, Bellville**



**UNIVERSITY of the
WESTERN CAPE**

Supervisor: ¹Prof. Lincoln Raitt

Co-supervisor: ²Prof. Roeland Samson

**1. University of the Western Cape, Department of Biodiversity and Conservation Biology,
P/Box17, Bellville 7535, South Africa**

**2. Antwerp University, Department of Bioscience Engineering, Groenenborgerlaan 171,
B2020, Antwerp, Belgium**

May 2010

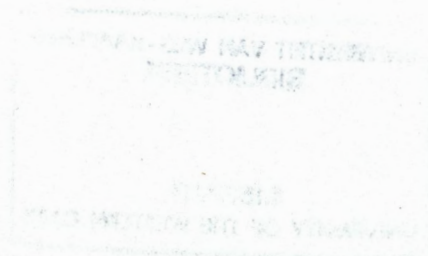



UNIVERSITY *of the*
WESTERN CAPE



The ecohydrology of the Franschoek Trust Wetland: water, soils and vegetation.

Key Words

Wetlands

Ecohydrology

Hydrologic regime

Management

Water table

Water chemistry

Vegetation

Soil

Nutrient availability

Topography



UNIVERSITY *of the*
WESTERN CAPE

ABSTRACT

The research was driven by a need to increase the knowledge base concerning wetland ecological responses, as well as to identify and evaluate the factors driving the functioning of the Franschhoek Trust Wetland.

An ecohydrological study was undertaken in which vegetation cover, depth to groundwater, water and soil chemistry were monitored at 14 sites along three transects for a 12 month period. The parameters used include temperature, pH, electrical conductivity (EC), sodium, potassium, magnesium, calcium, iron, chloride, bicarbonate, sulphate, total nitrogen, ammonia, nitrate, nitrite and phosphorus. T-tests and Principal Component Analysis (PCA) were used to analyze trends and to express the relationship between abiotic factors and vegetation.

Results reflect the strong influence of hydrology, microtopography and nutrient availability in structuring vegetation composition in the wetland. The wetland has been classified as a palustrine valley bottom with channel wetland, which is predominantly groundwater fed (phreatrotropic), but receives surface water inputs as well. Small scale gradients of microtopography allow for differences in flooding frequency and duration resulting in hydrologically distinct sites which differ chemically. Three zones were distinguished in the wetland. Hollows or low sites were characterized by intermittent flooding and drying and higher nutrient concentrations in soil and groundwater. High sites which were rarely or never flooded exhibited higher groundwater temperature and ammonia as well as iron in soils and groundwater. The inundated sites remained flooded throughout the year and were characterized by high nitrate and nitrite in soil as well as high EC, magnesium, bicarbonate, sulphate and phosphorus in groundwater. The limited availability of nitrogen in the wetland favoured plant types *Typha capensis*, *Paspalum urvillei* and *Juncus kraussii* which are able to either fix nitrogen or store nitrogen during more favorable conditions. The main chemical concentration changes take place between summer and winter. The Principal Component Analyses suggest that sodium, chloride, potassium, ammonia and phosphorus are the dominant ions determining the chemistry of groundwater. Increased abstraction from the table mountain aquifer to supplement human demand may put the wetland at risk of degradation. Intensified agriculture and other land use in the area are likely to increase pollution loads into the wetland causing shifts in nutrient

availability and vegetation composition. Continued and long term monitoring is essential to ensure effective management of the wetland and is highly recommended. Closer partnerships between wetland managers and scientists as well as community awareness and involvement through a volunteer monitoring programme should be encouraged



UNIVERSITY *of the*
WESTERN CAPE

May 2010

Declaration

I declare that *The ecohydrology of the Franschhoek Trust Wetland: water, soil and vegetation* is my own work, that it has not been submitted for any degree or examination in any other university, and that all the sources I have used or quoted have been indicated and acknowledged by complete references.

Ilse Kotzee

May 2010

Signed:



UNIVERSITY *of the*
WESTERN CAPE

Acknowledgements

First and foremost I would like to thank God for guiding me and providing me with the strength to finish this master's thesis.

I would also like to express my gratitude to the following persons:

The “**Vlaamse Inter-Universitaire Raad**” (VLIR) for their financial support, without which this research would not have been possible.

A special thanks to my supervisors **Prof. L.M. Raitt** and **Prof. R. Samson**. I am grateful for your support and guidance throughout the project.

Dr. Mosshine El-Kahloun who helped me with my research proposal and site selection thank you for your support, time and energy.

All of my **colleagues** who assisted me with my field and lab work in particular **Micah Dominique** and our technician **Mr.S.Davids** who toiled and sweated to install all the piezometers in the wetland.

To **Jaco Nel** for his support and willingness to help, not to mention all the braais, it is truly appreciated.

The staff of **BemLab (Stellenbosch)** for their analysis of the soil and plant samples.

Frikkie Calitz and **Marieta vd Rijst** from the ARC for their statistical support.

Lilburne Cyster for his assistance during labwork, especially the sample analysis on the Atomic Absorption Spectrometer.

Dane McDonald for taking time to assist me with my fieldwork thanks for the motivation and encouragement throughout.

Last but not least I would like to thank my parents and family for their encouragement, support and interest. A special thanks also goes to my friends, too numerous to list who has helped me in various ways during the course of the project.

Table of Contents

Key Words.....	i
ABSTRACT.....	ii
Declaration	iv
Acknowledgements.....	v
List of Figures.....	xi
List of Tables	xiv
List of Appendices	xiv
Chapter 1	1
Ecohydrology and the role of water regime in determining resource availability	1
1.1 Introduction	2
1.2 Ecohydrology	5
1.3 Structure and function of wetlands	6
1.3.1 Water.....	6
1.3.2 The role of groundwater.....	7
1.3.3 Soil.....	7
1.3.4 Vegetation	9
1.3.5 Nutrient availability	10
1.3.6 Microtopography	10
1.3 Aims	11
1.3.1 General aim	11
1.3.2 Specific aim.....	11
1.4 Research questions.....	11
Chapter 2.....	12
Methods used in the study of the Franschoek Trust Wetland	12

2.1 Study Area.....	13
2.1.1 Geology.....	14
2.1.2 Wetland type.....	16
2.2. Methodology.....	19
2.2.1 Field procedures	19
2.2.1.1 Water.....	20
2.2.1.2 Soil.....	20
2.2.1.3 Vegetation	20
2.2.1.4 Topographic Survey.....	21
2.2.2 Laboratory procedures.....	21
2.2.2.1 Water samples.....	21
2.2.2.2 Soil samples.....	21
2.2.2.3 Vegetation	22
2.2.3 Chemical Analysis of water, plants and soil.....	22
2.2.3.1 Water analysis.....	22
2.2.3.1.1 Nitrate.....	22
2.2.3.1.2 Nitrite	22
2.2.3.1.3 Ammonium.....	23
2.2.3.1.4 Bicarbonate Analysis.....	23
2.2.3.1.5 Chloride Analysis.....	24
2.2.3.1.6 Phosphate and sulphate ion analysis.....	25
2.2.3.2 Soil Analysis.....	25
2.2.3.2.1 Nitrate and Nitrite	25
2.2.3.2.2 Ammonium.....	25
2.2.3.3 Water and Soil Analysis	26
2.2.3.3.1 Digestion of sediment samples	26

2.2.3.3.2 Cation analysis.....	26
2.2.3.4 Plant and Soil Analysis.....	26
2.2.3.4.1 Nitrogen Analysis	26
2.2.3.4.2 Phosphorus Analysis	27
2.2.4 Statistical Analysis.....	27
Chapter 3.....	29
Seasonal Trends in, water sediments and vegetation	29
3.1 Results and discussion	30
3.2 Water.....	31
3.2.1 Groundwater.....	31
3.2.2 Groundwater Temperature	33
3.2.3 pH Measurements.....	34
3.2.4 Electrical Conductivity	35
3.2.5 Calcium.....	36
3.2.6 Magnesium.....	37
3.2.7 Sodium	38
3.2.8 Potassium	39
3.2.9 Iron Measurements	40
3.2.10 Bicarbonate.....	41
3.2.11 Chloride.....	42
3.2.12 Sulphate.....	43
3.2.13 Nitrogen Measurements	44
3.2.13.1 Ammonium.....	45
3.2.13.2 Nitrate.....	46
3.2.13.3 Nitrite	46
3.2.14 Phosphorus Measurement.....	47

3.2.15 Surface Water	49
3.2.16 Seasonal trend summary.....	52
3.2.17 Principal Component Analysis	52
3.2.17.1 Major cations and anions in groundwater; chemical relationship and source	52
3.2.17.2 Relationship between groundwater and vegetation.....	56
3.2.18 Water chemistry of the three hydrologic zones	60
3.3 Soil.....	61
3.3.1 pH measurements.....	61
3.3.2 EC measurements	62
3.3.3 Magnesium	63
3.3.4 Sodium	64
3.3.5 Potassium	65
3.3.6 Iron.....	66
3.3.7 Nitrogen	67
3.3.8 Ammonium.....	68
3.3.9 Nitrate	69
3.3.10 Nitrite	70
3.3.11 Calcium and Phosphorus.....	71
3.3.12 Soil seasonal trend summary	72
3.3.13 Relationship between groundwater and soil.....	72
3.3.13 Soil chemistry of the three hydrologic zones	72
3.4 Vegetation	75
3.4.1 Description and distribution of major vegetation zones.....	77
3.4.2 Biomass.....	79
3.4.3 Nitrogen and Phosphorus concentration	80
Chapter 4.....	83

Summary and recommendations83

 4.1 Summary84

 4.1.1 Hydrology.....84

 4.1.2 Topography85

 4.1.3 Nutrient availability.....85

 4.2 Conclusion.....86

 4.3 Recommendations88

 4.4 References89

Appendices.....99



UNIVERSITY *of the*
WESTERN CAPE

List of Figures

Figure 2.1 An aerial image showing the extent of the study wetland (indicated by ellipse), and the surrounding land use. (The image is from Google Earth, 2008).....	13
Figure 2.2 The geology of the study site, and approximate wetland area (indicated by ellipse) taken and adapted from 3319C Worcester, 3491A Caledon Geologic Map, Department of Mines, Geological Survey, Pretoria (1955)	15
Figure 2.3 A piezometer nest with piezometers installed at different depths	20
Figure 3.1 The variation in temperature measurement in groundwater from the Franschhoek Trust Wetland study area over the 2008-2009 study period. Points marked with the same letter on the graph do not differ significantly ($p \leq 0.05$).....	33
Figure 3.2 The variations in pH measurement in groundwater from the Franschhoek Trust Wetland study area over the 2008-2009 study period. Points marked with the same letter on the graph do not differ significantly ($p \leq 0.05$)	35
Figure 3.3 The variation in electrical conductivity in groundwater from the Franschhoek Trust Wetland over the 2008-2009 study period. Points marked with the same letter on the graph do not differ significantly ($p \leq 0.05$)	36
Figure 3.4 The variation in Ca in groundwater from the Franschhoek Trust Wetland over the 2008-2009 study period. Points marked with the same letter on the graph do not differ significantly ($p \leq 0.05$)	37
Figure 3.5 The variation in Mg in groundwater in the Franschhoek Trust Wetland over the 2008-2009 study period. Points marked with the same letter on the graph do not differ significantly ($p \leq 0.05$)	38
Figure 3.6 The variation in Na in groundwater in the Franschhoek Trust Wetland over the 2008 and 2009 study period. Points marked with the same letter on the graph do not differ significantly ($p \leq 0.05$)	39
Figure 3.7 The variation in K in groundwater in the Franschhoek Trust Wetland over the 2008-2009 study period. Points marked with the same letter on the graph do not differ significantly ($p \leq 0.05$).....	40
Figure 3.8 The variation in Fe in groundwater in the Franschhoek Trust Wetland in the 2008-2009 study period. Points marked with the same letter on the graph do not differ significantly ($p \leq 0.05$).....	41
Figure 3.9 The variation in HCO_3^- in groundwater in the Franschhoek Trust Wetland in the 2008-2009 study period. Points marked with the same letter on the graph do not differ significantly ($p \leq 0.05$)	42
Figure 3.10 The variation in Cl ⁻ in groundwater in the Franschhoek Trust Wetland in the 2008-2009 study period. Points marked with the same letter on the graph do not differ significantly ($p \leq 0.05$).....	43
Figure 3.11 The variation in SO_4^{2-} in groundwater in the Franschhoek Trust Wetland in the 2008-2009 study period. Points marked with the same letter on the graph do not differ significantly ($p \leq 0.05$)	44

Figure 3.12 The variation in ammonium in groundwater in the Franschoek Trust Wetland over the 2008-2009 study period. Points marked with the same letter on the graph do not differ significantly ($p \leq 0.05$)	45
Figure 3.13 The variation in nitrate in groundwater in the Franschoek Trust Wetland in the 2008-2009 study period. Points marked with the same letter on the graph do not differ significantly ($p \leq 0.05$)	46
Figure 3.14 The variation in nitrite in groundwater in the Franschoek Trust Wetland in the 2008-2009 study period. Points marked with the same letter on the graph do not differ significantly ($p \leq 0.05$)	47
Figure 3.15 The variation in P in groundwater in the Franschoek Trust Wetland in the 2008-2009 study period. Points marked with the same letter on the graph do not differ significantly ($p \leq 0.05$).....	49
Figure 3.16 An aerial image showing the wetland components (indicated by A, B and C) as well as surface water input and output sites.	50
Figure 3.17 Principal component analysis (PCA) of main water chemistry parameters tested for based on chemical relationship and water source.....	55
Figure 3.18 Principal component analyses on distribution of piezometers, elevation (m), average and maximum groundwater level (m). (The abbreviation P is for piezometer 1-14).....	58
Figure 3.19 Principal component analysis (PCA) of vegetation samples recorded in 5x5m plots around each piezometer along with elevation (m), average water level (m) and maximum water level (m).....	59
Figure 3.20 The variation in pH measurement in soil from the Franschoek Trust Wetland over the 2008-2009 study period. Points marked with the same letter on the graph do not differ significantly ($p \leq 0.05$).....	62
Figure 3.21 The variation in electrical conductivity in soil from the Franschoek Trust Wetland over the 2008-2009 study period. Points marked with the same letter on the graph do not differ significantly ($p \leq 0.05$)	63
Figure 3.22 The variation in Mg in soil in the Franschoek Trust Wetland over the 2008-2009 studies period. Points marked with the same letter on the graph do not differ significantly ($p \leq 0.05$).....	64
Figure 3.23 The variation in Na in soil in the Franschoek Trust Wetland over the 2008-2009 study period. Points marked with the same letter on the graph do not differ significantly ($p \leq 0.05$).....	65
Figure 3.24 The variation in K in soil in the Franschoek Trust Wetland in the 2008-2009 study period. Points marked with the same letter on the graph do not differ significantly ($p \leq 0.05$)	66
Figure 3.25 The variation in Fe in soil in the Franschoek Trust Wetland in the 2008-2009 study period. Points marked with the same letter on the graph do not differ significantly ($p \leq 0.05$)	67
Figure 3.26 The variation in N in soil in the Franschoek Trust Wetland in the 2008-2009 study period. Points marked with the same letter on the graph do not differ significantly ($p \leq 0.05$)	68
Figure 3.27 The variation in ammonium in soil in the Franschoek Trust Wetland in the 2008-2009 study period. Points marked with the same letter on the graph do not differ significantly ($p \leq 0.05$)	

Figure 3.28 The variation in soil nitrate in the Franschoek Trust Wetland in the 2008-2009 study period. Points marked with the same letter on the graph do not differ significantly ($p \leq 0.05$) 70

Figure 3.29 The variations in nitrite in soil in the Franschoek Trust Wetland in the 2008-2009 study period. Points marked with the same letter on the graph do not differ significantly ($p \leq 0.05$)..... 71

Figure 3.30 The distribution of major vegetation zones and piezometer placement in the Franschoek Trust Wetland in the 2008-2009 study period..... 76

Figure 3.31 Means and standard deviation of biomass in grams per square meter of the three most dominant species in the high, hollows and submerged zones respectively ($n=3$). 80

Figure 3.32 Nitrogen concentrations in above ground biomass of the dominant vegetation type in each hydrologic zone..... 82

Figure 3.33 Phosphorus concentrations in aboveground biomass of the dominant vegetation in each hydrologic zone..... 82

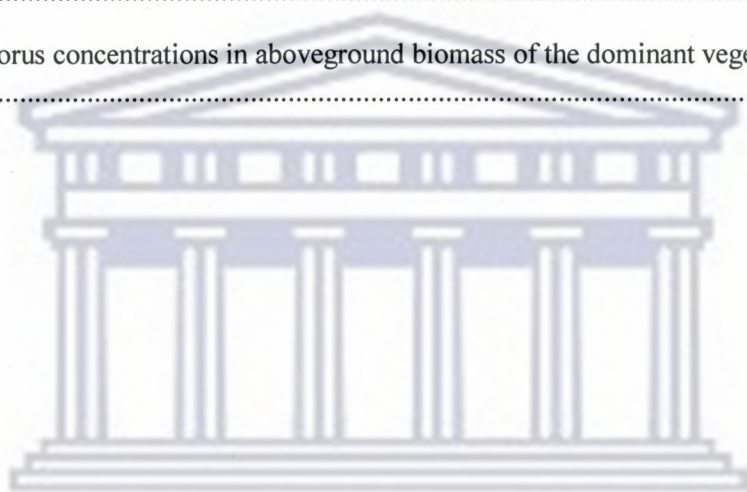

UNIVERSITY of the
WESTERN CAPE

List of Tables

Table 2.1: Wetland geomorphic types which typically support inland wetlands in South Africa (Kotze et. al. 2005).....	18
Table 3.1 The monthly averages of weather conditions at the site during study period 2008-2009 (Bridge House School, 2009).	30
Table 3.2 Collection times, months and season for 2008-2009 study periods	31
Table 3.3 The average depth to groundwater measurements in the Franschoek Trust Wetland for the study period 2008-2009. Points marked with the same letter do not differ significantly ($p \leq 0.05$)	32
Table 3.4 The average surface water concentrations of inlet and outlet identified sites within the Franschoek Trust Wetland for the study period 2008-2009	51
Table 3.5 The average groundwater concentrations for parameters tested in the three identified sites within the Franschoek Trust Wetland for the study period 2008-2009	60
Table 3.6 The variation in concentration of Ca and P elements in soil in the Franschoek Trust Wetland in the 2008-2009 study period. Points marked with the same letter do not differ significantly ($p \leq 0.05$).....	71
Table 3.7 The average soil mineral concentration of the three identified sites within in the Franschoek Trust Wetland for the study period 2009.....	73



UNIVERSITY of the
WESTERN CAPE

List of Appendices

Appendix I. Species names and abbreviations recorded using the Braun-Blanquet method99



UNIVERSITY *of the*
WESTERN CAPE



Chapter 1

**Ecohydrology and the role of water regime in determining
resource availability**

UNIVERSITY of the
WESTERN CAPE

1.1 Introduction

The maintenance of wetlands is pivotal due to the role they play in the water cycle (Bullock and Acreman, 2003). South Africa is a semi arid country where sparse vegetation, drought periods and flash floods are of common occurrence, the presence of wetland areas is thus highly desirable (Walmsley, 1988). Yet studies into the fundamental understanding of ecological functioning of wetlands have been extremely sparse in South Africa (Malan and Day, 2005). Lack of water quality monitoring data and limited research means most wetlands are poorly managed and degraded. Due to the inter connectedness of the hydrological and ecological processes of wetlands a complete ecohydrological study is essential in understanding how wetland systems function.

The hydrologic regime of a wetland refers to the annual and seasonal patterns of water levels, as well as the flow, frequency, duration and timing of flooding. In a wetland water levels change with the season, this means that they fluctuate constantly and are driven by factors such as change in climatic condition and topography (Deegan *et al* 2007; Smith and Brock, 2007). This dynamic nature of water is vital in maintaining wetland function and diversity as it affects primary production; controls organic accumulation; transports and drives nutrient cycling and is ultimately reflected in the composition, structure, diversity and zonation of vegetation (Ehrenfeld, 1983; Blom and Voesenek, 1996; Casanova and Brock, 2000). Land use changes have the ability to alter this sensitive hydrological balance (Richter *et al* 1996; Azous and Horner, 2001). Studies show that the types of adjacent land use, road density and human population density in the surrounding region all affect water flow into and through wetlands (Ehrenfeld, 1983). For instance due to increased urbanization hydrologic regimes have become more intensified with storm water runoff from agriculture and urban lands bringing excess water, nutrients and other contaminants to wetlands (Woo and Zedler 2002; Miller and Zedler; 2003). These changes will be reflected in the composition of vegetation (Ehrenfeld and Schneider, 1991; DeKeyser *et al* 2003) as the above-mentioned alterations are exploited by species that are better adapted to such conditions. A specific hydrology will therefore lead to a specific nutrient availability, which in turn allow for the occurrence of very specific vegetation (Wassen *et al* 1990). A clear understanding of how the water regime affects vegetation can therefore help in managing wetlands more predictively.

A wetland can be defined as land which is transitional between terrestrial and aquatic systems, where the water table is usually at or near the surface, or land that is periodically covered with shallow water, where the land in normal circumstances would support vegetation typically adapted to life in saturated soil (National Water Act No 36 of 1998). The requirements for wetland occurrence are favourable topographic and hydrogeologic conditions as well as a sufficient long term source of water (Michigan DNRE, 2001). Favourable topographic conditions for wetland development would be land surface depressions in the drainage basin, and favourable geological conditions refer to fine textured soil with low hydraulic conductivity of adequate thickness to store water. Depending on the main long term source of water wetlands can be categorized as either ombrotropic (fed solely by rainfall), fluviotropic (fed largely by inflows of surface water or phreatotrophic (groundwater fed) (Younger, 2006). Wetlands can also develop from a combination of any or all of these sources (Michigan DNRE, 2001)

Today wetlands are seen as one of the most important ecosystems on earth, providing a host of valuable functions such as the transfer and storage of water, the maintenance of biodiversity, the production of living plants and animals, the decomposition of organic materials and communities and habitats for living creatures. This was not the case in the past, unsustainable growth and development has seen the large-scale destruction of wetlands in both developed and undeveloped countries (Keddy, 2000). Wetland degradation has been so significant that 50% of the world's wetlands have been lost, with increasing stress placed on remaining wetland systems (Millenium Ecosystem Assessment, 2005). About 75 years ago a new movement was started in both the U.S.A and U.K geared at protecting the remaining areas of wetland habitat (Falconer and Goodwin, 1994). It took some time to shifts people's mind sets from reclamation to conservation, but gradually people's perceptions of wetlands has changed. The Convention on Wetlands of International Importance especially as Waterfowl habitat held in Ramsar, Iran in 1971, played an important role in placing wetlands under the international spotlight and has since catalysed the establishment of numerous wetland rehabilitation and conservation programs all over the world. Whilst institutional understanding of wetland conservation has grown most rapidly in the United States, countries such as Uganda, Sri-Lanka, Australia as well as the European Union has institutionalized wetland conservation policies (Dugan, 1990). South Africa

is a signatory of the Ramsar Convention and it is legislated under the Water Act (1998) that wetland water quality and quantity be maintained to ensure a given level of ecosystem functioning. Research however shows that despite these protective legislations and management initiatives wetlands are still under threat and losses continue (Patten and Doody, 1996).

Wetlands in the Western Cape and elsewhere in South Africa have been severely neglected in the past (Dallas *et al.* 2006). Consequently there is a general lack of information regarding wetland distribution, function and losses. According to Kotze *et al.* (1995) a wetland is considered to be “lost” if it has been degraded or developed to the point that it has lost a significant amount of its natural functional values, as would occur if it was severely eroded or drained and planted to pastures. In a wetland inventory undertaken by Dallas *et al.* 2006 (the first of its kind for South Africa) it was estimated that well over 50% of freshwater wetlands have already been destroyed due to development and poor management. More recent studies conducted in major catchments show that losses have increased to 60% (Water Research Commission, 2009). This is unnerving considering that marshes, swamps, bogs or vleis only constitute about 7% of South Africa’s surface area. Some of the anthropogenic activities that has led to destruction of wetlands in South Africa includes draining for planting of commercial crops or grazing, overgrazing of natural vegetation, dumping of industrial or domestic solid waste and pollution of wetland water supply (Coetzee, 1995). The quandary with which we are faced is that when large and conspicuous wetlands such as Lake St Lucia on the east coast of Kwazulu Natal (South Africa) is threatened it generates a large public interest, but it is the loss of small inconspicuous wetlands which are no less important that has been taking place without notice (Kotze *et al.* 1995).

Ecosystem conservation is interpreted by Turner *et al.* (2003) as efforts to manage environmental change in order to manage the goods and service provision over time. Wetland management is a relatively new field in South Africa, prior to 1990’s most public government services and landowners were ignorant on what wetlands were and their importance. There were no tertiary or post graduate training on wetland management and few conservationists advocated the wise use of wetlands only their preservation (Mondi Wetlands Program, 2009). According to Euliss *et al.* (2008) wetland management has been hugely unsuccessful worldwide, mainly due to management goals being focused on specific deliverables rather than processes that sustain ecosystems. Management strategies based on the sustainable utilization of ecosystems should be

entrenched in ecosystem integrity maintenance that is the maintenance of system components, interaction among them (functioning) and the resultant behaviour or dynamics of the system (Turner, 2003). Research therefore aims to investigate hydrological and ecological wetland balances as a means of creating scientifically credible information that allow for sound and informed management decisions.

1.2 Ecohydrology

The term “ecohydrology” was popularized in the early 1990’s and was enthusiastically received in fields like plant physiology and aqueous geochemistry (McClain, 2002). It was first formulated during the 5th phase of the UNESCO International Hydrological Programme (IHP-V 1996-2001) and was then further developed in IHP-VI (Zalewski *et al* 2003). The concept emerged out of a growing need to achieve sustainable development of water resources. Ecohydrology as the name suggests, entails research at the interface between the hydrological and biological (ecological) science. Ecology has been described as the science of the interrelationship between living organisms and their environment, whereas hydrology is the science of the hydrological cycle dealing with the properties, distribution and circulation of water in the environment

The last two centuries have seen an increase in population growth and human activities, which has placed considerable stress on freshwater resources and plant cover (Zalewski, 2000; 2002). The hydrotechnical approach to water management that was used up to this point was focused on using engineering to solve problems such as point source pollution and flood control often to the detriment of biodiversity cultural and aesthetic values disturbing ecosystem processes (Zalewski, 2000). Ecohydrology in its inception was therefore seen as an application driven interdiscipline with the goal of better understanding the hydrological factors which determine the natural development of wet ecosystems (Wassen, and Grootjans, 1996). Baird and Wilby (1999) have since broadened the environmental context to include not only wet ecosystems but ephemeral dryland, forest, stream, river and lake systems as well, arguing that the same processes take place in these ecosystems as well. Further studies highlighted the importance of investigation into the interrelation between biota and water, so as to gain insight into the plant communities influence on the structure and function of ecosystem as well (Nuttle, 2002).

Ecohydrology can therefore be more adequately described as “the sub-discipline shared by the ecological and hydrological sciences that are concerned with the effects of hydrological processes on the distribution, structure, and function of ecosystems, and on the effects of biotic processes on elements of the water cycle” Nuttle (2002). According to Rodriguez-Iturbe (2000) an important goal for ecohydrology is to explore the relation in space and time between climate, soil and vegetation, which together form the core of hydrology.

1.3 Structure and function of wetlands

Wetlands consist of three major components namely: water, soil and vegetation. Understanding the characteristics and interaction between each one of these components is essential if wetland management is the objective.

1.3.1 Water

Wetlands may receive water from three sources namely precipitation, groundwater and surface flow, each contributing differently to the ionic composition of the wetland (Brinson, 1993). Understanding hydrology will therefore provide a good indication of wetland functioning. According to Moreno-Casasola and Vazquez (1999) the water table levels in a wetland are affected by the variability of rainfall as well as the balance between precipitation input and groundwater. One of the easiest ways to measure a wetland’s hydrology is therefore to record the variation in water levels (Van der Valk, 2006). According to Azous and Horner (2001) the amount of groundwater in a wetland at a specific time is dependant on the relative elevations of surface water in the wetland and surrounding groundwater, as well as soil permeability, local geology and topography. Water level fluctuation is a regular occurrence in wetlands and can oscillate daily, seasonally and at different amplitudes, due to varying rates of water loss and recharge (Wheeler, 1999) for plant growth (Wierda *et al* 1997). Any modification to the source and amount of water entering the wetland, being stored or leaving the wetland will result in changes in the functioning of the wetland (Van der Valk, 2006). This can be ascribed to water

regime changes altering the physical habitat characteristics of water such as temperature, pH, oxygen content and chemistry (Richter *et al* 1996).

1.3.2 The role of groundwater

Surface and groundwater interaction is very important in wetland ecosystems, although very little attention has been given to it in the past. The general perception was that once water infiltrated into the subsurface it was lost to the above ground ecosystem (González Bernáldez, 1992). Today we know that a wetland can either recharge a groundwater aquifer (if the water level in the wetland is higher than the water table of its surroundings) or groundwater can discharge into a wetland (if the surface water or groundwater level is lower than the water table of the surrounding land) (Mitch and Gosselink, 2007). In Mediterranean areas characterized by dry summers the relationship between rain and groundwater becomes even more important since groundwater seeping into these wetlands has a stabilizing role, which regulates water levels and ensures that the wetland remains flooded (González Bernáldez, 1992).

As water flows through an aquifer it dissolves minerals such as calcium, sodium, bicarbonate and chloride giving it new chemical characteristics (Ramsar Convention Kampala, 2005). In addition the temperature of the water will adjust to that of the rocks, so that groundwater chemical and thermal properties will differ significantly from that of surface water. Groundwater discharging into the wetland therefore not only contributes to the water level but also to the availability of specific ions and nutrients as well (Wassen *et al* 1990).

1.3.3 Soil

Wetlands all have one distinguishing feature, and that is, soil that is at least periodically inundated by a rising water table or flooding. Wetland soils or hydric soils are defined as “soils that formed under conditions of saturation, flooding, or ponding long enough during the growing season to develop anaerobic conditions in the upper part” (U.S Department of Agriculture Natural Resource Conservation Service, 1998). Hydric soils are separated from other soil because when a soil becomes flooded it sets off a chain of reactions, which has an influence on the chemical, physical and biological processes of soils (Pezeshki, 2001). In water flooded soils

pores previously filled with air become filled with water so that soil- atmospheric gas exchange becomes severely restricted (Blom and Voeselek, 1996). The soil oxygen still remaining is rapidly consumed by roots and anaerobic microorganisms, for respiration, resulting in a soil with severely reduced oxygen which sets into motion a series of electrochemical, chemical and biological changes (Ponnamperuma 1972). These chemical and biological alterations in the soil leads to changes in the availability and concentration of various nutrients and toxic substances which strongly affects soil quality and subsequently plant growth (Pezeshki, 2001).

Hydric soils can be grouped into two types based on its material composition, namely organic soils in which aerobic conditions (wetland soils are mostly under anaerobic conditions when flooded) promote the accumulation of organic matter (organic carbon, of minimum 10% and 200 mm of organic material occurs in the upper 800mm of soil) and mineral soils which has less organic carbon than organic soils (less than 10% organic carbon) (Federal Interagency Committee for Wetland Delineation, 1989). In mineral soils gleying is the most widely recognized effect of prolonged saturation. The localized formation of yellow red or brown mottles can also be observed due to repeated re-precipitation of reduced iron (Mitch and Gosselink, 2007).

The properties of wetland soil vary within space and time and can contrast greatly between the wet and dry extreme (Seelig and DeKeyser, 2006). Elevation plays a major role here as soil in the deepest parts of the wetland can be permanently flooded, while at higher elevations only intermittently flooded (van der Valk, 2006). The degree of soil wetness in turn influences soil properties and consequently soil biogeochemical cycling (Seelig and DeKeyser 2006). Research done by Koerselman *et al* (1993) shows that water level, as well as the properties of the water overlying the soil will determine the rate at which nutrients such as nitrogen, potassium and phosphorus will be released from the soil. According to Hunt *et al* (1997) the biogeochemical active zone of a wetland is very close to the sediment surface, making it extremely susceptible to variations in temperature, precipitation, infiltration and nutrient loading. Previous research has shown that wetland soils that come into contact with groundwater will follow the geochemical

gradient of the groundwater (Benayas *et al* 1993). Elevation and geochemical gradients therefore play an important role in wetland soil chemistry and subsequently the composition of plant communities.

1.3.4 Vegetation

Within any wetland site there can be considerable variation in the water table level due to changes in the landscape (Van der Valk, 2006). These variations bring about contrasting habitat conditions, which allows for the development of different vegetation types (Yabe and Onimaru, 1997). A study done by Casanova and Brock (2000) shows that species group together based on their ability to tolerate water level fluctuations. Many wetland plants have evolved to tolerate inundation through morphological adaptive strategies and timing of important life cycle events (Blom and Voesenek, 1996; Miller and Zedler, 2003). The distribution and pattern of plant communities in wetlands are therefore largely controlled by the wetland's water regime.

Vegetation however is not passive to its environment and undergoes significant changes during its growing season, which can have considerable influence on its environment both in space and time (Mitch and Gosselink, 2007). Some of the ways in which wetland plants affect its surroundings include the improving of water quality via filtration, adsorption and cation exchange (Wright and Otte, 1999), the limitation of erosion and reduction of water flow through stabilization of sediments by plant roots (Cronk and Siobhan Fennessy, 2001), the control of water loss through evapotranspiration (Roberts, 2000) and the release of oxygen into soil through their roots (Mainiero and Kazda, 2004). According to Ridolfi *et al* (2006) one of the key mechanisms affecting the dynamics of wetland vegetation is the two-way interaction between groundwater and vegetation. Different kinds of plant canopies can also alter light regime, water temperature, oxygen concentration and water chemistry to create complex microenvironments (Van der Valk, 2006).

1.3.5 Nutrient availability

The availability of nutrients in a wetland is determined the presence of plants, the prevailing hydrological regime, as well as sediment and watershed characteristics (Cronk and Siobhan Fennessy, 2001). Resource availability drives ecosystem succession and nutrient availability has been shown to be an important determinant of species composition, distribution and productivity (Willby *et al* 2001; Güsewell and Bollens, 2003). According to Grieve *et al* (1995) nutrient availability can vary in space and time and is controlled by factors such as ion chemistry, relative contribution of rainfall, groundwater as well as hillslope inputs, and how these interact with the biogeochemistry of the wetland. It is the amount of nutrients available for consumption by plants that usually determines plant biomass production (Olde Venterink *et al.*2002). As a result nutrient concentrations in plant biomass has widely been used as a means of assessing availability of nutrients as well as the extent to which nutrients are limiting to plants (Willby *et al* 2001; Güsewell and Bollens, 2003). Nutrient limitation is tested in plants as it has been proven to also play a role in the distribution of vegetation (Koerselman and Meuleman, 1996). Research done by Verhoeven *et al* (1996) shows that most wetland sites are limited by either nitrogen (N), phosphorus (P) or potassium (K) or a combination of these. The composition of the parent soil material, turn over rate of nutrients and input and output balances will determine whether nitrogen, phosphorus or potassium is limiting primary production (Verhoeven and Schmitz 1991). Vermeer and Barendse (1983) postulate that at the height of the growing season the nutrient concentration of the above ground biomass is a reliable indicator of the total amount of nutrients available in the growing season.

1.3.6 Microtopography

Microtopography refers to the elevational or topographic heterogeneity of substrates at the scale of individual plants (Titus, 1990). In natural wetlands elevation heterogeneity comes about as a consequence of sediment accumulation, erosion, tree fall, root growth, litter fall, animal burrowing and vehicle and animal tracks (Bruland and Richardson, 2005). The scale of soil surface variability can range from as little as 0.01 m to more than 1 m (Vivian-Smith, 1997). The result of these micro topographic differences is a complex array of micro sites with substrates that are hydrologically, chemically and structurally different (Titus, 1990). According to Deegan

et al (2007) the persistence and degree of flooding of a plant by a given rise in water level will increase with decreasing elevation, so that a plant growing at low elevations will experience flooding at a greater magnitude than plants growing at high elevations. Due to the individualistic response of plant species to frequency and magnitude of surface flooding even slight differences in the depth of the water table will result in significant differences in herbaceous and woody vegetation at these sites (Bledsoe and Shear, 2000). Microtopography is thus a key factor in promoting the development of vegetation structure and composition and ultimately ecosystem function (Moser *et al* 2007) Sites will differ chemically as a result of differences in aeration, redox potentials, patterns of litter accumulation, compaction levels and drought incidence (Bruland and Richardson, 2005). This means a variety of hydrologic, soil and vegetation conditions can occur in a wetland at any give time over the course of the growing season.

1.3 Aims

1.3.1 General aim

To assess the impact of the hydrological regime on the distribution of vegetation, in the Franschoek Trust Wetlands, in order to provide a basis from which the wetland can be managed more effectively.

1.3.2 Specific aim

To determine the relationship between water regime, water chemistry, soil chemistry, and nutrient availability. This will be done through setting up a monitoring network in which water quality parameters, soil chemistry and vegetation nutrient content will be analyzed for a period of 12 months in order to cover seasonal events.

1.4 Research questions

What chemical concentration changes are taking place within the wetland on a seasonal basis?

Which environmental variables have the strongest effect on vegetation distribution?

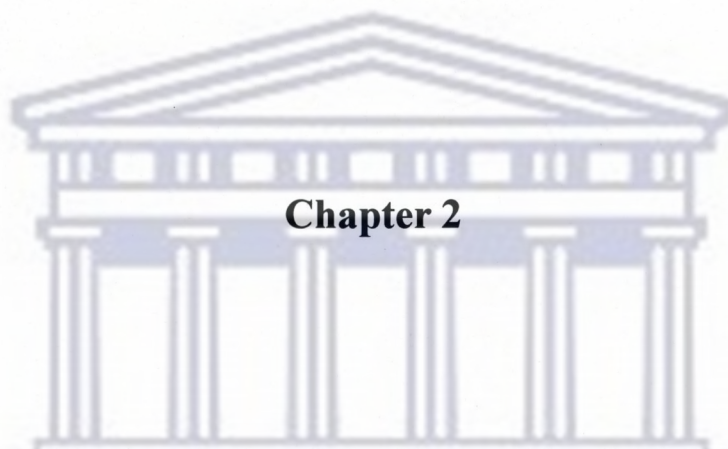

Chapter 2

Methods used in the study of the Franschoek Trust Wetland

UNIVERSITY *of the*
WESTERN CAPE

2.1 Study Area

The Franschhoek Trust Wetland is situated in the Franschhoek valley, in the South-Western Cape Province of South Africa. This region experiences a Mediterranean-type climate with warm dry summers and cool wet winters. Franschhoek normally receives about 863mm of rainfall annually, with 80% of rainfall within the months of April to September (Görgens and de Clercq, 2006). Average summer maximum and minimum daily temperatures are in the order of 27° C and 13° C respectively, corresponding winter temperatures are 20° C and 8° C.

Present land cover in the area primarily falls within three types: agriculture, forestry and urban, with agriculture making up the largest proportion of the catchment as a whole (Görgens and de Clercq, 2006). The study wetland has an extent of approximately 0.75 km², but has been separated into three parts (identified as parts A, B and C) due the construction of a major highway (Fig. 2.1). The construction of the highway took place during a time when not much consideration was given to the ecological importance of wetlands.

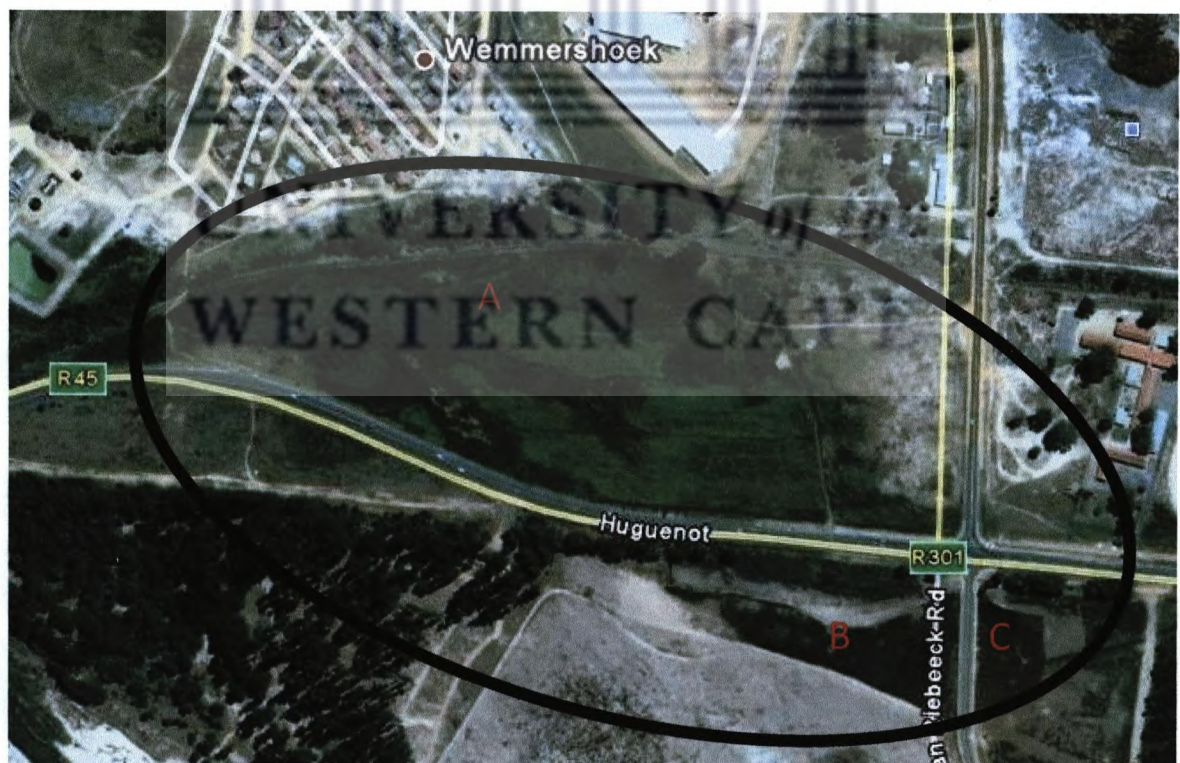

Figure 2.1 An aerial image showing the extent of the study wetland (indicated by ellipse), and the surrounding land use. (The image is from Google Earth, 2008)

2.1.1 Geology

It is important to note the effect of geologic factors on wetlands as underlying geology has been shown to influence the local landform, soil type and surface water movement, recharge and base flow maintenance of the aquifer (Palmer *et al* 2002). The geology of the study site and the surrounding area was deduced from the geologic map below (Fig. 2.2). According to the map the area in which the wetland occurs is predominantly covered in alluvial deposits. According to Freeman and Rowntree (2005) alluvium is typically made up of a variety of materials, including fine particles of silt and clay and larger particles of sand and gravel. The surrounding mountains are made up of quartzite, sandstone and thin bands of shale and conglomerate. This is typical for the geology of the Table Mountain Group which according to Wu (2005) is made up of a thick sequence of quartz arenite, and minor shale layers. From the map it can be seen that there is a fault line (indicated by the arrows) running directly through the study site. According to Lisle (1988) faults are formed as a result of deformation of rocks and can be thought of as structural discontinuities along which appreciable displacement of layering has taken place. This could mean that the study area has a combination of fine shale, granite porphyry and TMG geology underneath the layer of alluvium. Since no drilling has taken place in the area, and no borehole logs exists, this is yet to be confirmed. It is also interesting to note that a tributary of the Berg River used to run through the wetland.

UNIVERSITY of the
WESTERN CAPE

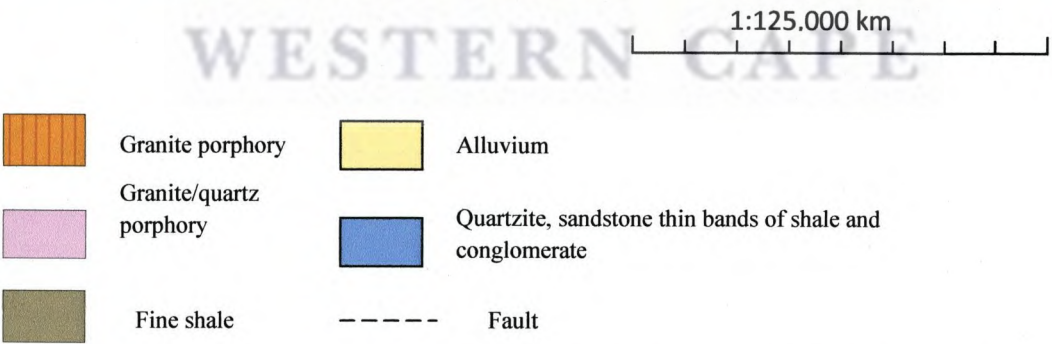
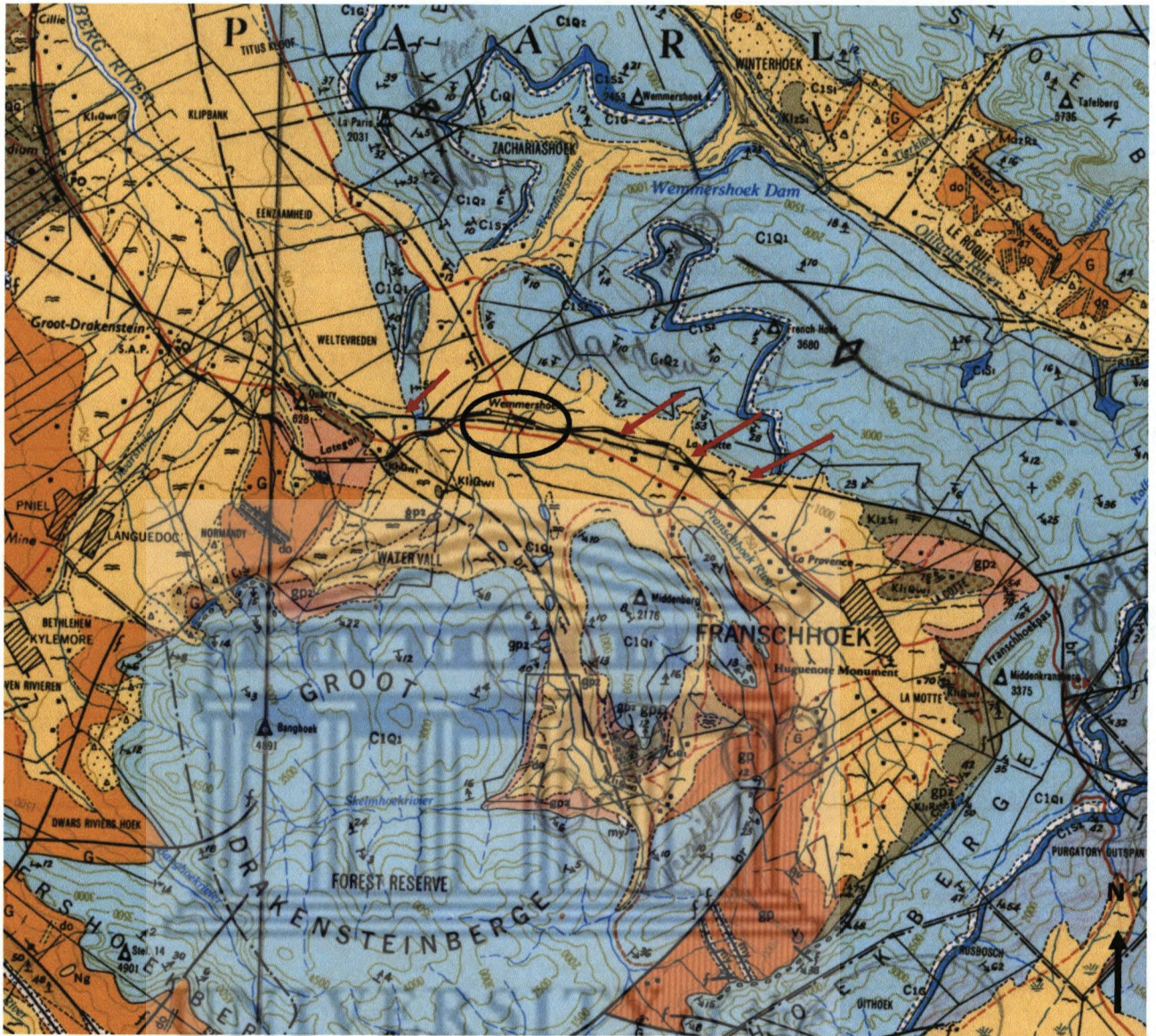

Figure 2.2 The geology of the study site, and approximate wetland area (indicated by elipse) taken and adapted from 3319C Worchester, 3491A Caledon Geologic Map, Department of Mines, Geological Survey, Pretoria (1955)

2.1.2 Wetland type

In South Africa wetlands are classified into different types according to the Cowardin system, which classifies wetlands as either marine, estuarine, riverine, palustrine or lacustrine (Cowardin *et al* 1979). This hierarchical method characterizes wetlands according to system, class, plant community and substrate, water regime and water chemistry. This particular wetland falls within the palustrine wetland category and is described by Cowardin *et al* (1979) as all non-tidal wetlands dominated by trees, shrubs persistent emergents, emergent mosses, or lichens, and all such wetlands that occur in the tidal areas where salinity stemming from ocean-derived salts is below 0.5 g/l. It also includes wetlands lacking such vegetation but with all of the four following characteristics: (1) area less than 8 ha; (2) lack of active wave-formed or bedrock shoreline features; (3) water depth in the deepest part of the basin less than 2m at low level and (4) salinity stemming from ocean derived salts less than 0.5 g/l. The hydrology of most of these wetlands is affected by precipitation, groundwater discharge and surface water runoff in varying degrees (Tiner, 1999). The majority of wetlands found in South Africa has a palustrine nature (Schwirzer, 2006) and are usually found in areas where the mean annual rainfall exceeds 500 mm (Malan and Day, 2005).

According to Tiner (1999) palustrine wetlands may be permanently, periodically or never flooded, but will be saturated for extended periods during the year. Due to South Africa being a semi arid region, with predominantly seasonal rainfall, our palustrine wetlands are usually integrated with the fluvial network (Ellery, 2005).

The wetland can be further classified based on its hydrogeomorphic setting. At the heart of this classification lie three components namely: (a) geomorphic setting, (b) water source and its transport, and (c) hydrodynamics (Brinson, 1993). With geomorphic setting referring to the topographic location of the wetland, water source can be simplified to precipitation, surface or near surface flow, and hydrodynamics referring to the direction and strength of water movement within the wetland. In order for this concept to fit into the South African context Kotze *et al* (2005) has identified six geomorphic types: floodplain, valley bottom with a channel, valley bottom without a channel, hillslope seepage feeding a water course, hillslope seepage not feeding a water course and depression (Table 2.1). It is important to note that all these wetlands are

palustrine wetland types. Based on the characteristics displayed by the study wetland it can be placed in the valley bottom with channel wetland category. According to Ewart-Smith *et al*, 2006) a valley bottom is a low lying, gently sloped area that receives water from an upstream channel and or from adjacent hillslopes, not subject to over-bank flooding by a river channel.



UNIVERSITY *of the*
WESTERN CAPE

Table 2.1: Wetland geomorphic types which support inland wetlands in South Africa (Kotze *et al*2005)

Hydro-geomorphic types	Description	Source of water maintaining the wetland ¹	
		Surface	Sub-surface
<i>Floodplain</i>	Valley bottom areas with a well defined stream channel, gently sloping and characterized by floodplain features such as oxbow depressions and natural levees and the alluvial (by water) transport and deposition of sediment. Water input from main channel (when channel banks overspill) and from adjacent slopes.	***	*
<i>Valley bottom with a channel</i>	Valley bottom areas with a well defined stream channel, but lacking characteristic floodplain features. May be gently sloped and characterized by the net accumulation of alluvial deposits and may have steeper slopes and may be characterized by the net loss of sediment. Water inputs from main channel (when channel banks overspill) and from adjacent slopes.	***	*/***
<i>Valley bottom without a channel</i>	Valley bottom areas with no clearly defined stream channel usually gently sloped and characterized by alluvial sediment deposition, generally leading to a net accumulation of sediment. Water inputs mainly from channel entering the wetland and also from adjacent slopes.	***	*/***
<i>Hillslope seepage feeding a watercourse</i>	Slopes on hillslopes which are characterized by the colluvial (transport by gravity) movement of materials. Water inputs are usually from sub-surface flow and outflow is usually via a well defined stream channel connecting the area directly to a water course.	*	***
<i>Hillslope seepage not feeding a watercourse</i>	Slopes on hillslopes which are characterized by the colluvial (transport by gravity) movement of materials. Water inputs are usually from sub-surface flow and outflow either very limited or through diffuse sub-surface and/ surface flow but with no direct surface water connection to a watercourse.	*	***
<i>Depression (includes pans)</i>	A basin shaped area with a closed elevation contour allows for the accumulation of surface water (i.e. it is inward draining) It may also receive subsurface water. An outlet is usually absent.	*/***	*/***

Key

Precipitation is an important water source and evapotranspiration an important output in all the above settings

Water source * Contribution usually small

*** Contribution usually large

*/ *** Contribution may be small or important depending on the local circumstances

2.2. Methodology

The research methodology consisted of both field tests and laboratory analyses. The parameters examined include groundwater level, temperature, electrical conductivity (EC), pH, dissolved oxygen (DO), nitrite (NO_2^-), nitrate (NO_3^-), ammonium (NH_4^+), sodium (Na), magnesium (Mg), Iron (Fe), Calcium (Ca), potassium (K), phosphate (PO_4^{2-}), bicarbonate (HCO_3^-), chloride (Cl^-), sulphate (SO_4^{2-}), total nitrogen (N) and total phosphorus (P).

2.2.1 Field procedures

Field monitoring was carried out in what is known as the Franschoek Trust Wetland. Three transects were established in order to determine the relationship between hydrology, soil and vegetation. All along these three transects shallow and deep piezometers were placed, they were constructed from 5 cm PVC pipes, in which diagonal slits were made in the bottom 20 cm to allow for the free entry of water. This was then covered with a nylon stocking to prevent clogging of the slits with sediment. The piezometers were installed at depths of 1 m, 1.5m and 2m (See Fig. 2.1). Piezometers, also known as groundwater observation or dip wells were used as a means of obtaining quantitative information about the shallow hydrologic regime of the wetlands. Placement was dependant on the presence of homogenous and sufficiently large vegetation patches. After installation the piezometers were purged with a bailer and covered with a pvc end cap to prevent contamination by insects and rainwater. In one area, boulders presumably from old river terrace prevented the installation of piezometers deeper than 1 m, as a result only one piezometer was installed in this particular area. An additional four, piezometers were later installed at a depth of 1 meter in areas, which did not fall within the three transects but which had significant vegetation zones.

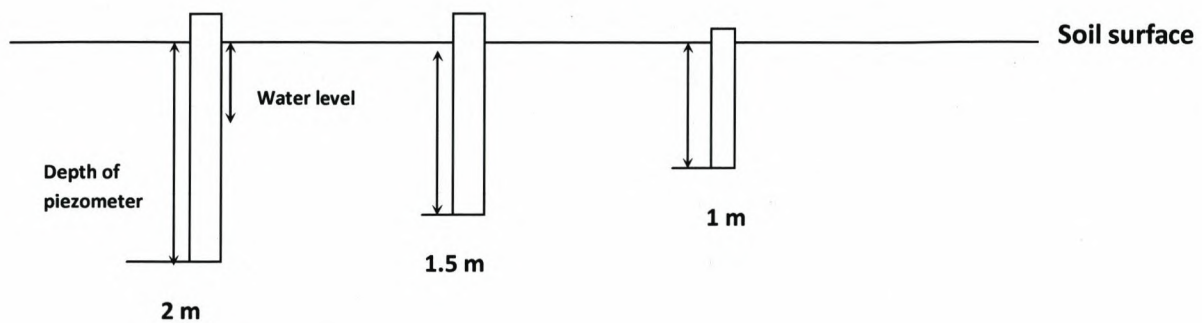

Figure 2.3 A piezometer nest with piezometers installed at different depths

2.2.1.1 Water

In all of the piezometers depth to water table, electrical conductivity and temperature were determined on a monthly basis with the aid of a 100 m TLC dipmeter (Solinst Model 107, Temperature Level Conductivity meter, Canada). Water samples were collected into 500 ml plastic containers for further analysis in the lab. Surface water samples from a series of wetland inputs, which comprised of a number of ditches around the wetland and one output, were also collected during the rainy season. Depth to water table, electrical conductivity and temperature were determined in-situ with a TLC dip meter (Solinst Model 107), Temperature Level Conductivity meter, Canada), dissolved oxygen was determined with a hand held oxygen meter (YSI Model 55 Handheld Dissolved Oxygen System, USA).

2.2.1.2 Soil

Soil samples were collected in the areas surrounding the 14 piezometer sites; sample collection started in November 2008 with subsequent samples collected in the same areas every three months thereafter. At each of the 14 sites five replicates from the top (0-10 cm) soil were taken with an auger and mixed. Of this a representative sub-sample was taken, and transferred into a zip lock bag which was stored in a cooler box until analysis in the lab.

2.2.1.3 Vegetation

Vegetation investigations were undertaken to understand biomass production as well as richness, composition and structure of wetland plant communities. All major vegetation zones were mapped with the aid of a Google satellite image taken on 15 February 2005. Vegetation zones were ground-truthed in November 2008 with the use of a handheld GPS unit (Garmin, Model 60,

USA). Biomass harvesting was started in February and took place bimonthly hereafter up until August. Above ground biomass was harvested in 1x1 m² plots by clipping the vegetation at ground level. Three random plots were selected in three major vegetation zones dominated by *Typha capensis*, *Paspalum urvillie* and *Juncus kraussii*. The clipped vegetation from each plot was collected and placed into individual garden refuge bags for analysis in the lab.

The vegetation around each piezometer was sampled in 5x5m quadrats in October 2009. Species composition and percent cover was visually estimated for all vegetation using the Braun-blanquet method. Unidentified species were sampled and taken to a plant expert to be identified. In the instances where plants had no fruits or flowering parts, plants were identified up till species level.

2.2.1.4 Topographic Survey

A topographic survey was conducted in May 2009 in which height and distance of all 14 piezometer points was recorded. This was done in order to examine surface characteristics that might influence the wetland's hydrology.

2.2.2 Laboratory procedures

2.2.2.1 Water samples

Water samples were centrifuged at 3000 RPM for fifteen minutes (Beckman Model TJ-6, USA) in order to clear them of sediment. The pH was then determined (PHM 64 Research pH meter, Radiometer, Denmark). Aquamerck reagent kits and a RQ reflex instrument (Merckoquant^R, Germany) were used to determine levels of nitrate, nitrate and ammonium ions.

2.2.2.2 Soil samples

Soil was air-dried for at least 2 days until completely dry, and then put through a 2 mm sieve. Soil pH and soil conductivity was measured at *sticky point* with a pH meter (PHM 64 Research pH meter, Radiometer, Denmark) and a conductivity meter (Metrohm 644 conductometer, Switzerland) respectively.

2.2.2.3 Vegetation

The above ground vegetative biomass collected in the field was transferred from the refuge bags into brown paper bags and oven dried at 70°C to constant weight. The oven-dried samples were then weighed, after which a sub sample of each was ground with a Wiley Mill, placed into a container and labelled.

2.2.3 Chemical Analysis of water, plants and soil

2.2.3.1 Water analysis

2.2.3.1.1 Nitrate

Nitrate ions were tested using a Reflectoquant^R Nitrate Test. A test strip was immersed in the measurement sample for approximately 2 seconds. In the reaction that takes place nitrate ions are reduced to nitrite ions by a reducing agent. In the presence of an acidic buffer these nitrite ions react with an aromatic amine to form a diazonium salt, which in turn reacts with N-(1-naphthyl)-ethylene-diamine to form a red-violet azo dye. After the allocated reaction time of 60 seconds the strip was inserted into the strip adapter of a RQ reflex instrument which displayed a result in mg/l NO₃⁻. The RQ reflex instrument used, works according to the principle of reflectometry (remission photometry) where reflected light from the strip is measured. The reflected light then allows for a quantitative determination of specific analytes, which can be read off the display of the instrument.

2.2.3.1.2 Nitrite

Nitrite ions were tested using a Reflectoquant^R Nitrite Test. A test strip was immersed in the measurement sample for approximately 2 seconds. In the reaction that takes place, nitrite ions in the presence of an acidic buffer react with an aromatic amine to form a diazonium salt, which in turn reacts with N-(1-naphthyl)-ethylene diamine to form a red-violet azo dye. After the allocated reaction time of 15 seconds the strip was inserted into the strip adapter, of the RQ reflex instrument, which displayed a result in mg/l NO₂⁻.

2.2.3.1.3 Ammonium

Ammonium ions were determined with a Reflectoquant^R Ammonium Test, which consists out of a tube with 50 test strips, one bottle of reagent NH_4^{-1} and one bottle of reagent NH_4^{-2} as well as a test vessel with a stopper. In this procedure the test vessel was rinsed several times with the water sample and then filled to the 5-ml mark. Ten drops of reagent NH_4^{-1} was added to the sample and swirled well. One level micro spoon of NH_4^{-2} was then added to the sample and shaken until the reagent was dissolved in the water. A test strip was then immersed in the measurement sample for eight minutes. In the reaction that takes place ammonium ions reacts with a chlorinating agent to form monochloramine. This in turn reacts with a phenol compound to form a blue indophenol derivative. At the end of the reaction time the strip was inserted into the strip adapter, of the RQ reflex instrument and a result was displayed in mg/l NH_4^+ . Water samples were then stored at 4°C in a cold room until further analysis.

2.2.3.1.4 Bicarbonate Analysis

Water samples were sent to a commercial laboratory for analysis of bicarbonate (Bemlab Pty Ltd). The following wet chemistry reagents were used: sodium carbonate 0.05N; hydrochloric acid 0.05N; phenolphthalein indicator solution (0.5%*m/v*) and a mixed indicator solution. In order to standardize the hydrochloric acid 20 ml of sodium carbonate solution was added with a pipette into an Erlenmeyer flask. 5 drops of mixed indicator solution was added to this and then titrated with the hydrochloric acid until the solution turned purple. Normality was calculated using the following formula:

$$\text{Normality of HCL} = \frac{\text{volume Na}_2\text{CO}_3 \cdot \text{N Na}_2\text{CO}_3}{\text{volume HCl}}$$

Titration was performed in triplicate and the mean of the result was used. 20 ml of the water sample was then added with a pipette into an Erlenmeyer flask to which 5 drops of phenolphthalein indicator was then added. If the colour turned pink it was titrated with the standardized 0.05N hydrochloric acid until the solution turned colourless. Another 5 drops of mixed indicator was added to the colourless solution and titrated further with 0.05 N hydrochloric acid until the solution turned purple. The bicarbonate concentration was calculated using the following formula:

$$\text{Bicarbonate (mg/l HCO}_3^-) = 3050 * N \text{ HCl} * V$$

Where:

A = phenolphthalein endpoint

B = mixed indicator endpoint

V = Value (ml) calculated using the table below

Result	Hydroxide	Carbonate	Bicarbonate
A = 0			B
A < ½B		2A	B - 2A
A = ½B		2A	
A > ½B	2A - B	2(B - A)	
A = B	B		

2.2.3.1.5 Chloride Analysis

Water samples were sent to a commercial laboratory for chloride analysis (Bemlab, Pty Ltd.).

The following wet chemistry reagents were used; sodium chloride solution 0.05 N; silver nitrate solution 0.05N and potassium chromate indicator solution. In order to standardize the silver nitrate solution 20 ml of silver nitrate solution was added with a pipette into an erlenmeyer flask. To this 5-10 drops of potassium chromate indicator was added and was then titrated with silver nitrate until the solution turned red-brown. Normality was calculated using the following calculation:

$$\text{Normality of AgNO}_3 = \frac{\text{volume NaCl} * N \text{ NaCl}}{\text{volume AgNO}_3}$$

The titrations were done in triplicate and the mean of the result was used.

A pipette was used to add 20 ml of water sample to an Erlenmeyer flask, to this 5-10 drops potassium chromate was added and then titrated with the standardized silver nitrate until the solution turned brown-red. If the titration was greater than 25 ml an appropriate dilution was prepared and the titration repeated.

The chloride concentration was calculated: Chloride (mg/l Cl = 1773*N AgNO₃*T

Where:

T = titration value of the silver nitrate

2.2.3.1.6 Phosphate and sulphate ion analysis

Phosphate and sulphate were analyzed using inductively coupled plasma optical emission spectrometry (ICP) at a commercial laboratory. (Bemlab, Pty Ltd)

2.2.3.2 Soil Analysis

2.2.3.2.1 Nitrate and Nitrite

The nitrate and nitrite content in soil samples were determined reflectrometrically using a Reflectometer (RQflex, Merck, Germany). In this procedure 100 g of soil sample was accurately weighed into a beaker and then homogenised with 100ml distilled water by shaking for 30 minutes on a platform shaker (Innova 2100, New Jersey). After shaking the homogenized solution was immediately filtered through nitrate-free filter paper. The solution was then analyzed for nitrate and nitrite in the same way as the water samples using a Merkoquant^R Nitrite or Merkoquant^R Nitrite Test and reflectometer (RQflex^R, Merck, Germany). Nitrate and nitrite was calculated using the following formula:

Nitrate or nitrite content (mg/kg) = Measured value (mg/l)*Vol.distilled water (ml)/weight of sample (Merck, 2006)

2.2.3.2.2 Ammonium

The ammonium content in soil samples were determined reflectrometrically using a reflectometer (RQflex^R, Merck, Germany). In this procedure 100g of soil sample was accurately weighed into a beaker and then homogenized with 100ml of 0.0125 M CaCl₂ solution by shaking it for one hour on a platform shaker (Innova 2100, New Jersey). The 0.0125 M CaCl₂ solution was prepared by adding 1.838g of Calcium chloride dehydrate to 1 liter distilled water. The homogenized solution was immediately filtered through filter paper and analyzed for ammonium

in the same way as the water samples using a Reflectoquant^R Ammonium Test and reflectometer (RQflex^R, Merck, Germany). Ammonium content was calculated using the following formula:

Ammonium content (mg/kg) = Measured value (mg/l)*vol.CaCl₂ sol (ml)/weight of sample (g)
(Merck, 2006)

2.2.3.3 Water and Soil Analysis

2.2.3.3.1 Digestion of sediment samples

Sediment samples were digested using aqua regia solution, HCl: HNO₃ (3:1). One gram of sediment was weighed and placed into a digestion tube with 12 ml digestion mixture. Samples were digested for three hours at 110°C. After evaporation to near dryness, the tubes were removed and allowed to cool. The samples were diluted with 20 ml of 2 % (v/v with H₂O) nitric acid. It was then quantitatively transferred into a 100 ml volumetric flask after filtering through Whatman no.42 filter paper and diluted to volume with distilled water.

2.2.3.3.2 Cation analysis

The water and soil solutions were analyzed for Na, K, Mg, Fe, and Ca, using a Unicam Solaar M Series Atomic Absorption Spectrometer (AAS) with an air/acetylene flame system.

2.2.3.4 Plant and Soil Analysis

2.2.3.4.1 Nitrogen Analysis

Plant and soil samples were sent to a commercial laboratory for analysis (Bemlab, Pty Ltd) Nitrogen content for soil and plant samples were determined by means of a Nitrogen Analyzer (LECO, Corp, USA) which operates based on the catalytic thermal decomposition chemiluminescence method. For the analysis approximately 0.05g of the soil or plant sample was weighed in a tarred tin foil cup and the weight recorded. An encapsulated sample was then placed into the loading head of the nitrogen analyzer, where it gets sealed and then purged of any atmospheric gases that might have entered during the loading of the sample. The sample is then

dropped into a hot furnace (600-900°C) and flushed with pure oxygen for rapid combustion. During this process which is called the catalytic thermal decomposition method nitrogen monoxide (NO) is generated. The nitrogen monoxide (NO) is then reacted with ozone (O₃), resulting in the formation of nitrogen dioxide (NO₂) which excited in a metastable state generates chemiluminescence when it becomes stable nitrogen dioxide (NO₂). The intensity of this chemiluminescence is proportional to the nitrogen concentration. The nitrogen analyzer detects the chemiluminescence and so measures the nitrogen concentration in the sample. The system is controlled by an external personal computer using Windows^R based operating software, from which the results was then downloaded.

2.2.3.4.2 Phosphorus Analysis

The Murphy and Riley (1962) method was used to determine the total phosphorus concentration of plants and sediments. The Murphy and Riley solution was made with the following wet chemistry reagents: sulphuric acid, ammonium molybdate, ascorbic acid, potassium antimonyl tartrate and a pale yellow solution was obtained. During the Murphy and Riley procedure, a standard curve, using (2; 4; 8; 20; 30)g phosphorus) was prepared before running the digested samples. For the analysis 4 ml of digested plant sample or digested sediment sample were placed into 50 ml volumetric flasks to which 8 ml of Murphy and Riley solution was added and then diluted to volume with distilled water. One hour was allowed for colour development of standards and samples. The absorbance was measured at wavelength of 882 nm using a Shimadzu 160-A UV visible spectrophotometer. The phosphorus concentration was calculated using the following formula:

$$P \text{ (mg/g) (plant and soil)} = \text{Concentration (mg)} * \text{solution volume (ml)} / \text{aliquot size (ml)} * \text{sample mass (g)}$$
 (Moore & Chapman, 1986)

2.2.4 Statistical Analysis

T-tests were used to compare the means of samples at $p \leq 0.05$. Descriptive statistics was applied to the data sets in order to check for annual trends. The relationship between hydrology,

water chemistry, elevation and the vegetation cover was reviewed using Principal Component Analysis (PCA). For all statistical analysis XLSTAT, 2009 software was used.



UNIVERSITY *of the*
WESTERN CAPE



Chapter 3

Seasonal Trends in, water sediments and vegetation

UNIVERSITY *of the*
WESTERN CAPE

3.1 Results and discussion

A weather station located near the site and basic details of the weather is provided in Table 3.1. During the study period the highest average temperatures were recorded in November to March with the highest maximum temperature in March. Average temperatures decreased from May to September, increasing again in October. The lowest temperature was recorded in June. Highest average humidity recorded was in June and May with the lowest humidity in March. Highest measured rainfall occurred in May, 2008 was an exceptionally wet year with unusually high rainfall in November.

Table 3.1 The monthly averages of weather conditions at the Franschoek Trust Wetland site during study period 2008-2009 (Bridge House School, 2009).

Date		Temperature			Humidity	Wind	Rain
Month	Year	Min	Avg	Max	Avg	Avg	Total
Nov	2008	11.9°C	19.7°C	34.9°C	53%	6.2 kts	218.4 mm
Jan	2009	12.8°C	21.6°C	33.2°C	55%	6.1 kts	0.0 mm
Feb	2009	13.8°C	23.3°C	37.1°C	50%	7.7 kts	38.1 mm
Mar	2009	13.2°C	25.2°C	38.3°C	49%	5.1 kts	2.5 mm
Apr	2009	11.8°C	18.9°C	29.0°C	58%	21.4 kts	17.8 mm
May	2009	3.6°C	14.6°C	29.9°C	70%	17.4 kts	825.0 mm
Jun	2009	1.9°C	13.3°C	26.6°C	70%	45.0 kts	245.0 mm
Jul	2009	4.8°C	12.3°C	36.2°C	61%	0.9 kts	9.8 mm
Aug	2009	4.9°C	13.4°C	26.9°C	62%	2.2 kts	63.9 mm
Sep	2009	5.2°C	13.8°C	23.8°C	67%	4.1 kts	67.2 mm
Oct	2009	5.8°C	16.8°C	30.6°C	59%	9.6 kts	31.7 mm

A detailed layout of field collection dates is provided in Table 3.2. The site was visited once a month for a period of 12 months.

Table 3.2 Collection times, months and season for 2008-2009 study periods

Month	Year	Field time (days)	Season
Sep	2008	0	Spring
Oct	2008	28	Spring
Nov	2008	61	Spring
Dec	2008	90	Summer
Jan	2009	133	Summer
Feb	2009	160	Summer
Mar	2009	194	Autumn
Apr	2009	222	Autumn
May	2009	250	Autumn
Jun	2009	291	Winter
Jul	2009	314	Winter
Aug	2009	350	Winter

3.2 Water

The major ions of natural inland waters are derived from the rocks with which they are in contact and from the atmosphere (Dallas and Day, 2004). The ions most commonly found in natural waters are the cations calcium, magnesium, sodium and potassium, and the anions bicarbonate, carbonate, chloride and sulphate.

3.2.1 Groundwater

The groundwater inputs into the Franschoek Trust Wetland are relatively permanent. Permanent wetlands contain water throughout the year except in extended drought. During the

study period mean groundwater levels ranged between 169.05 cm and 169.69 cm, this means that the average water level fluctuation was only 0.58cm (Table 3.3). Water level fluctuations are determined by the level of urban or agricultural development, with highly developed areas having higher water level fluctuations (Euliss and Mushet, 1996). The low fluctuation can be explained by continuous groundwater inputs and the presence of an outlet in the wetland which prevents extreme rises and fluctuations of groundwater levels, by reducing the time water remains in the wetland after a flood event. Variation in depth to water table in the wetland was largely determined by the elevation at different sites (See Section 3.2.1). However the major increases may be limited to high rainfall (Table 3.1).

Table 3.3 The average depth to groundwater measurements in the Franschhoek Trust Wetland for the study period 2008-2009. Points marked with the same letter do not differ significantly ($p \leq 0.05$)

Days passed	0	28	61	90	133	194	222	250	291	314	350
Depth to water (cm)	169.69a	169.05a	169.61a	169.45a	169.43a	169.42a	169.50a	169.61a	169.69a	169.68a	169.67a

3.2.2 Groundwater Temperature

Temperature affects the rate of several biological processes such as the oxygen holding capacity of water (causing lower oxygen levels at high temperature) and photosynthetic rate of aquatic plants (Darrin Fresh Water Institute, 2009; Kadlec 2006). An increase in water temperature will result in greater biological activity and more rapid growth. Temperature also influences water chemistry, with rates of chemical reactions generally increasing with increasing temperature. Temperature alteration can be attributed to weather, removal of shading, discharge of cooling water and urban storm water, and groundwater inflow to the wetland. In wetland water temperatures are subject to both diurnal and annual cycles, corresponding to the cycles in solar radiation (Kadlec, 1999). Wetland water temperature will thus vary seasonally.

The wetland water temperature changed significantly over the study period. During the study mean temperature levels varied between 13.5°C and 20.74 °C (Fig. 3.1). Results show mean temperature values at 16.3°C in early spring, then increasing in summer to 20.7°C and then gradually decreasing to 13.5°C in the colder winter months.

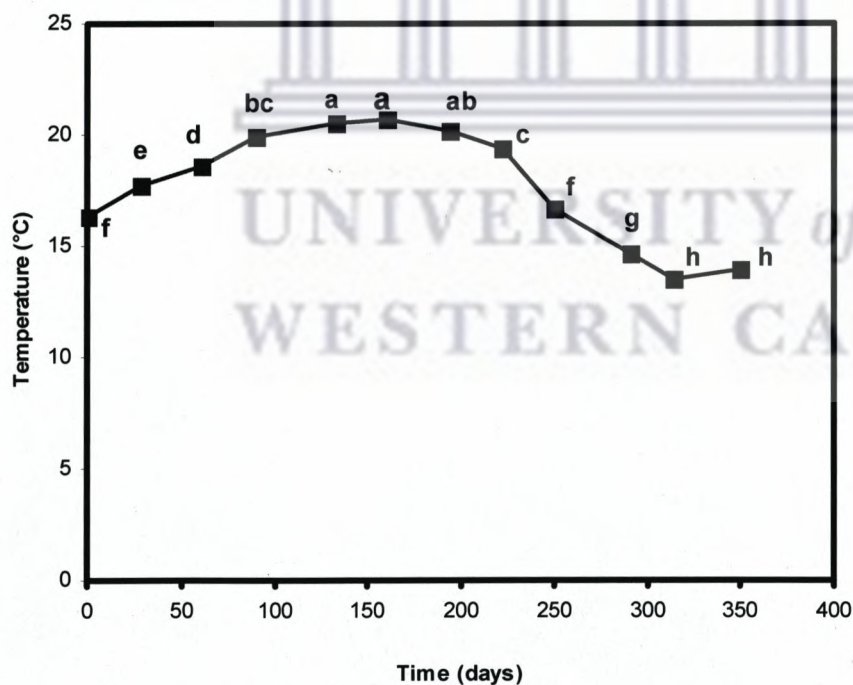

Figure 3.1 The variation in temperature measurement in groundwater from the Franschoek Trust Wetland study area over the 2008-2009 study period. Points marked with the same letter on the graph do not differ significantly ($p \leq 0.05$)

3.2.3 pH Measurements

pH is a term used to indicate the alkalinity or acidity of a substance as ranked on a scale from 1.0 to 14.0. Acidity increases as the pH gets lower (Darrin Fresh Water Institute, 2009). An increase in pH can be due to an increase in salinity or an increase in photosynthetic rate. A pH of 7.0 is neutral. As pH increases alkalinity increases. Aquatic organisms differ as to the range of pH in which they flourish (Dallas and Day 2004). In natural waters pH is determined by geological and atmospheric influences. The pH of groundwater controls which cations, anions, gases and solids dissolve into groundwater (Domenico and Schwartz, 1998).

The mean range of groundwater pH in the wetland ranged between 5.91 and 6.5 (Fig. 3.2).

Results show significant fluctuation in pH throughout the year, highest pH was measured on day 314 (July) when recorded rainfall was significantly lower than previous high rainfall months (Table 3.1). The lowest pH was measured on day 250 (May) it is highly probable that groundwater was flushed out completely due to the high rainfall recorded for this month (Table 3.1). The target water quality range for irrigation water is 6.5-8.4. According to DWAF (1996b) pH levels below 6.5 such as we find here, may cause accumulation of heavy metals over the long term, this is not big a concern as wetland plants are known for their heavy metal tolerance (Brookes (1998))



UNIVERSITY of the
WESTERN CAPE

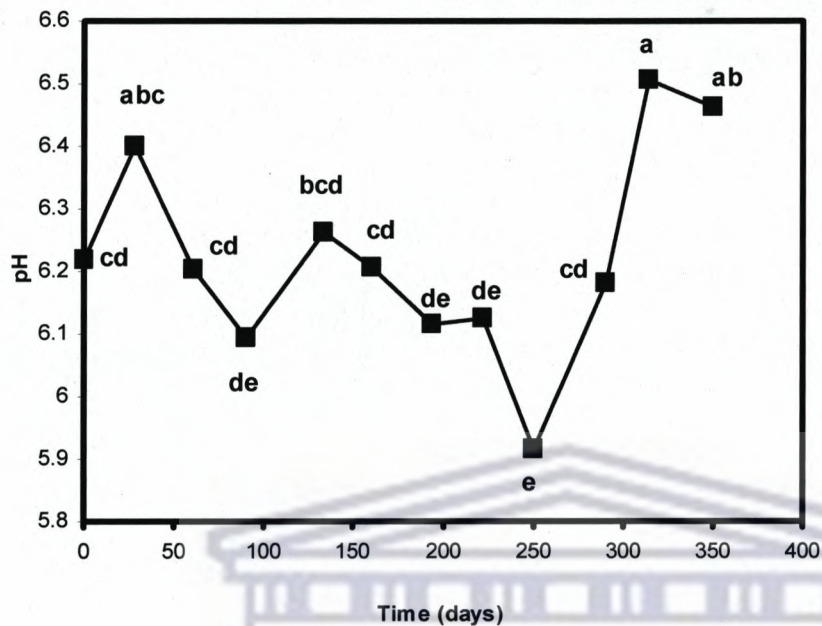

Figure 3.2 The variations in pH measurement in groundwater from the Franschoek Trust Wetland study area over the 2008-2009 study period. Points marked with the same letter on the graph do not differ significantly ($p \leq 0.05$)

3.2.4 Electrical Conductivity

Conductivity is a measure of the ability of a sample to conduct an electric current (Palmer *et al*/2004). In water it is generally used as a measure of its mineral or ionic concentration. Electric conductivity depends on the concentration of the ions, the temperature of the solution (the higher the temperature the higher the EC) and the specific nature of the ions (higher specific ability and higher valence leads to a higher EC) (United Nations Environment Program, 2009).

During the study period there were significant changes in mean EC for groundwater, with values ranging between 164.31 and 481.7 $\mu\text{S}/\text{cm}$ (Fig. 3.3). From the results it would appear that EC underwent changes which are highly influenced by rainfall patterns (Table 3.1). For the study period EC concentrations remained fairly constant from September to November, with sharp increases observed in December and January (summer months which are characterized by very little rainfall). EC levels then gradually returned to previous levels in February and March when the low rainfall summer season draws to an end. Levels then increased with the first rains in April and then stabilized slightly during May and June which on average is the highest rainfall

months for this part of the country. EC then returned to the previous levels measured during the spring months (Table 3.2) this drop coincides with significantly less rainfall during the month of July (Table 3.1). EC levels seemed to respond again with the rainfall in August.

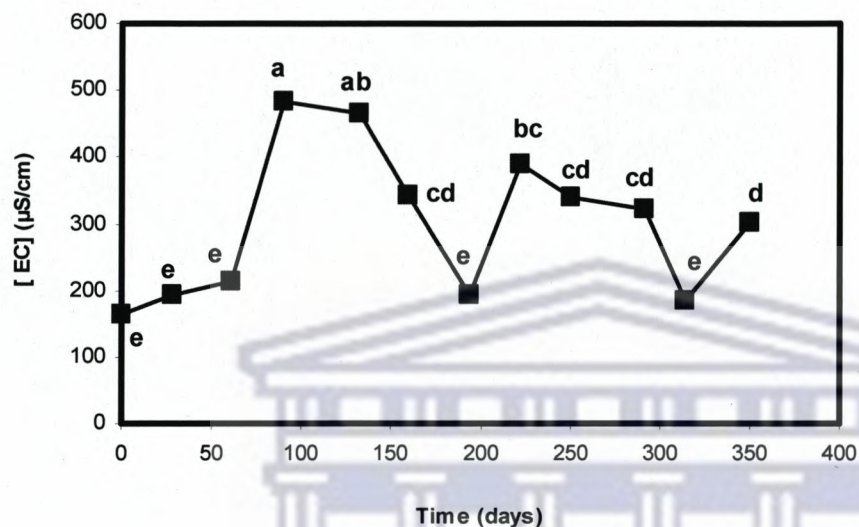

Figure 3.3 The variation in electrical conductivity in groundwater from the Franschoek Trust Wetland over the 2008-2009 study period. Points marked with the same letter on the graph do not differ significantly ($p \leq 0.05$)

3.2.5 Calcium

Calcium (Ca^{2+}) is one of the major elements vital for living organisms (Dallas and Day, 2004) and is taken up by plants in considerable amounts (Orzepowski and Pulikowski, 2008). Calcium is essential for many plant functions which include proper cell division and elongation, proper cell wall development, nitrate uptake and metabolism, enzyme activity and starch metabolism (Spectrum Analytic Inc., 2010). One of the main sources of calcium in groundwater is silicate minerals, due to the ubiquitous nature of calcium in rocks, calcium is found almost everywhere in groundwater (Karanth, 1987; Gladstone Bell, 1998). Factors influencing Ca^{2+} abundance includes: Acidic pH (processes like acid rain and nitrification, increase the concentration of Ca^{2+} in water and soil), cation competition (high levels of other cations decreases Ca^{2+} availability), and excess sodium (Orzepowski and Pulikowski, 2008; Spectrum Analytic Inc, 2010). In non acidified fresh groundwater Ca^{2+} is usually the main cation (Griffioen, 2001). The south-western Cape however is known for its Ca^{2+} poor waters (Dallas and Day, 2004).

During the study period average values of Ca in groundwater were in the range of 0.59 and 2.8 mg/l (Fig. 3.4). The highest concentration of Ca was measured in November with no significant changes during the rest of the study period. The increase in Ca concentration in November coincides with a decrease in potassium (Fig. 3.7). The sudden drop in Ca measured on day 90 (December) may also be ascribed to an increase in potassium in the same month (Fig. 3.7). There are no water quality guidelines for irrigation water or aquatic ecosystems for calcium in South Africa.

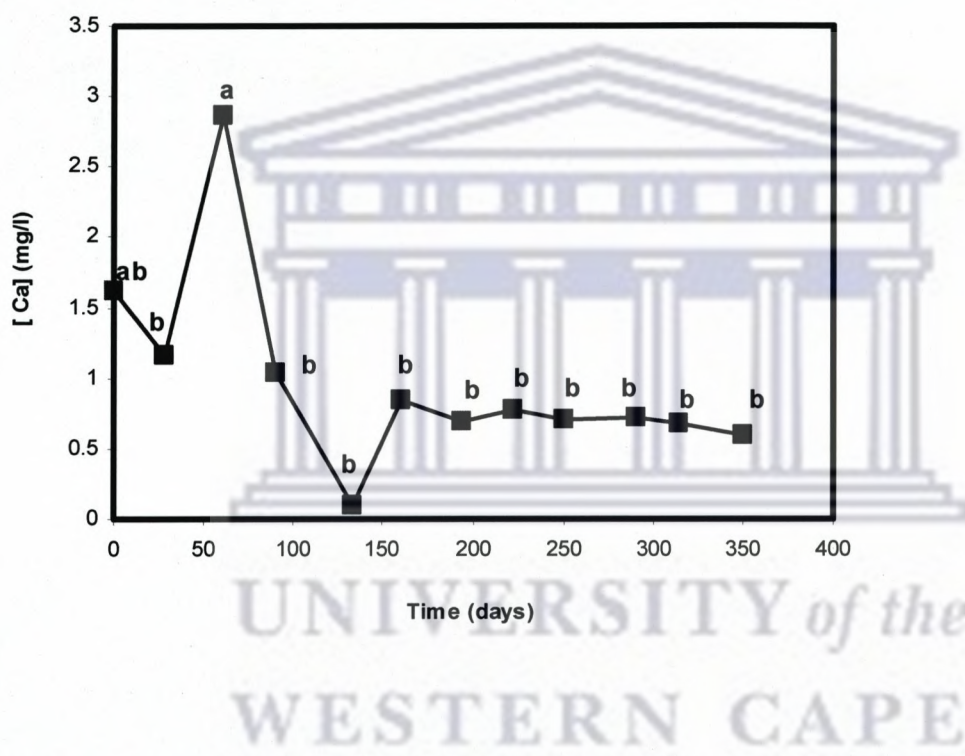

Figure 3.4 The variation in Ca in groundwater from the Franschoek Trust Wetland over the 2008-2009 study period. Points marked with the same letter on the graph do not differ significantly ($p \leq 0.05$)

3.2.6 Magnesium

Magnesium (Mg^{2+}) is an important element which is taken up by plants in large amounts. It is a constituent of chlorophyll and activates a number of enzymatic reactions (Orzepowski and Pulikowski, 2008). It is abundant in rocks and soils, particularly limestones and dolomites (Krešić, 2007). Magnesium can also end up in water as a result of run off from industrial waste, the application of fertilizers and cattle feed (Minnesota Pollution Control Agency, 1999).

According to Orzepowski and Pulikowski (2008) in natural waters the content of calcium is 3-4

fold higher than that of Mg. This can be ascribed to the general lower abundance of Mg (Krešić, 2007). Low pH and temperature decreases the availability of Mg and vice versa (Spectrum Analytic, 2010).

During the study period there were significant changes in the concentration of Mg in groundwater, mean concentrations ranged between 0.44 to 0.63 mg/l (Fig. 3.5). On day 222 (April) and 250 (May) concentrations were significantly lower than previous months. This drop in concentration coincides with a decrease in both water temperature (Fig. 3.1) and pH (Fig. 3.2).

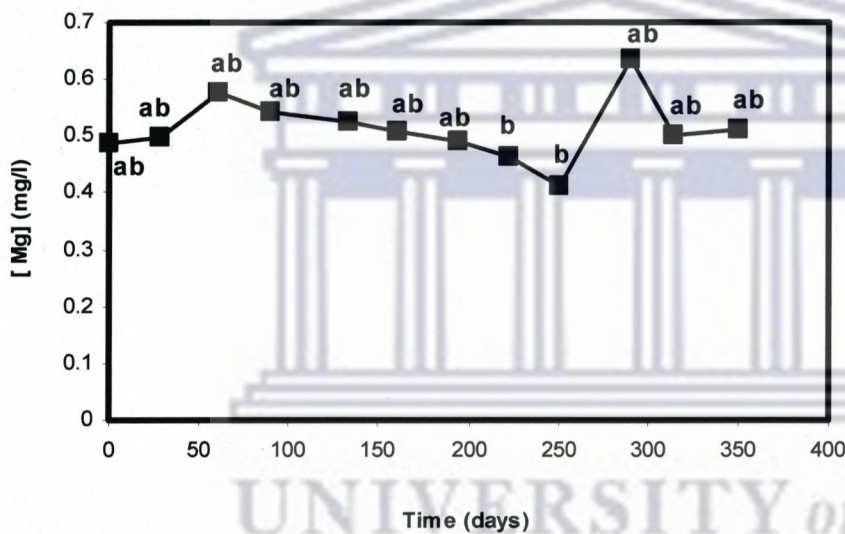

Figure 3.5 The variation in Mg in groundwater in the Franschoek Trust Wetland over the 2008-2009 study period. Points marked with the same letter on the graph do not differ significantly ($p \leq 0.05$)

3.2.7 Sodium

Sodium (Na^+) is highly soluble and is naturally found in rocks and soil and subsequently in groundwater. Sodium and potassium fall within a group called the alkali earth metals (Minnesota Pollution Control Agency, 1999). Sodium is known to play a major role in the regulation of ionic, osmotic and water balance in all organisms (Dallas and Day, 2004). Sources of sodium include, erosion of salt deposits and sodium bearing rocks and naturally brackish water aquifers,

(British Columbia Ground Water Association, 2007). According to Rail (2000) the greatest sodium concentration occurs when in association with chloride ions.

In the study period there was a significant change in the groundwater Na concentration, mean concentrations ranged between 1.74 and 2.3 mg/l (Fig. 3.6). Sodium concentrations are well below the target water quality range of 70mg/l for irrigation water (DWAF, 1996a).

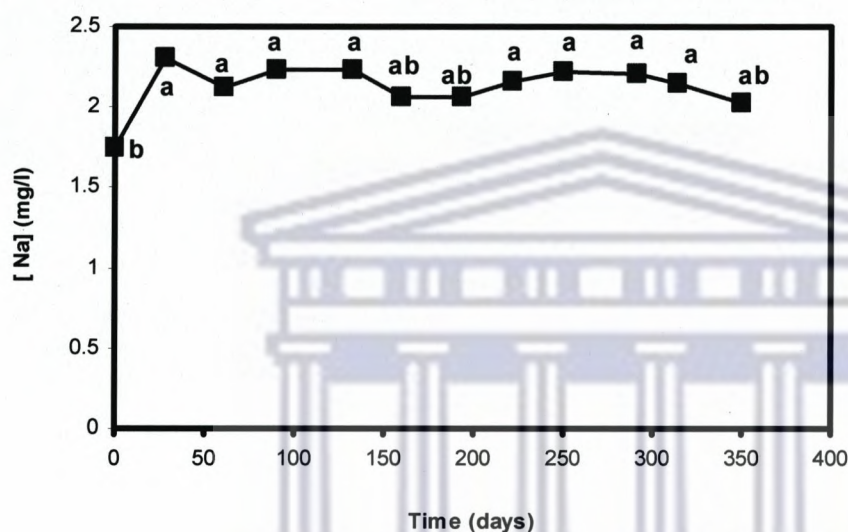

Figure 3.6 The variation in Na in groundwater in the Franschhoek Trust Wetland over the 2008 and 2009 study period. Points marked with the same letter on the graph do not differ significantly ($p \leq 0.05$)

3.2.8 Potassium

Potassium (K^+) plays a role in synthesis and respiration processes, and regulates the hydration of tissues (Orzepowski and Pulikowski, 2008). In plants potassium can act as a limiting nutrient, as it can occur in much lower concentrations than the similar element sodium (Dallas and Day, 2004) which is not required by most plants. Potassium salts are highly soluble, and transport in groundwater is controlled mainly by cation exchange especially on clay minerals (Griffioen, 2001). Sources of potassium are surrounding geology and soil, deposition in rainfall as well as agricultural activities. According to Spectrum Analytic Inc (2010) potassium availability is influenced by cation balance (significant imbalance between potassium, calcium and magnesium may affect K availability), acid pH (as pH is reduced availability of K is reduced), and temperature (low temperature known to reduce the availability of K).

In the study period there was a significant change in K concentration for groundwater, mean concentration varied between 3.8 and 7.9 mg/l (Fig. 3.7).

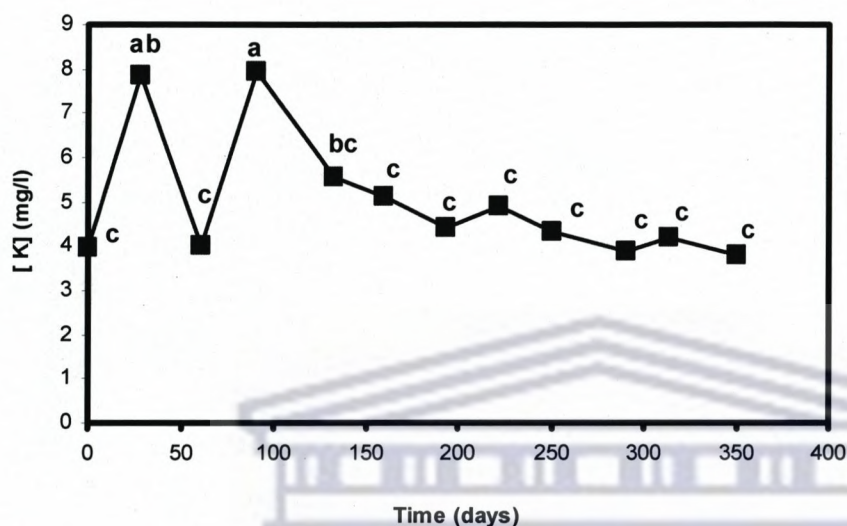

Figure 3.7 The variation in K in groundwater in the Franschoek Trust Wetland over the 2008-2009 study period. Points marked with the same letter on the graph do not differ significantly ($p \leq 0.05$)

An abrupt increase in K was found to have occurred on day 28 (October) and day 90 (December) with concentrations then gradually decreasing over time. The increase in average groundwater K concentration by day 28 (Oct) may be ascribed to a number of factors, including increased water pH (Fig. 3.2) and comparatively low Ca and Mg concentrations (Fig. 3.4 and Fig. 3.5). By day 61 (November) average Ca concentrations (Fig. 3.3) had increased significantly which may account for the drop in K concentration. On day 90 (December) average K concentration had increased significantly, this coincided with a decrease in both Ca and pH concentration at the same time. As temperatures began to drop toward winter, K concentrations decreased as well. There is no guideline for potassium in the South African water quality guideline for aquatic ecosystems or irrigation water.

3.2.9 Iron Measurements

Iron (Fe) is a common component of geological material and is slowly released from soil and rocks to groundwater (Minnesota Pollution Control Agency, 1999). In most cases iron occurs

naturally in rocks in relatively high concentrations. Factors affecting iron concentration are pH (high pH causes low Fe availability, while low pH increases Fe availability), low organic matter (organic matter compounds are able to form soluble Fe complexes which improves availability), saturated, compacted or poorly aerated soils is known to increase Fe availability, HCO_3^- (presence of bicarbonate can induce iron deficiency) (Spectrum Analytic Inc, 2010).

During the period of investigation the mean Fe concentration in groundwater varied between 0 and 37.53 mg/l (Fig. 3.8). Results show one significant change where iron levels dropped in October from a fairly high concentration in September Fe levels remained low throughout the rest of the year with the lowest concentration measured at 0.92mg/l on day 350. The decline in Fe may be attributed to an increase in HCO_3^- in the same month (Fig. 3.9). During most of the study period iron levels were below the target water quality range of 5mg/l for irrigation water (DWA, 1996a) except for September when average concentration of Fe was 37.53 mg/l.

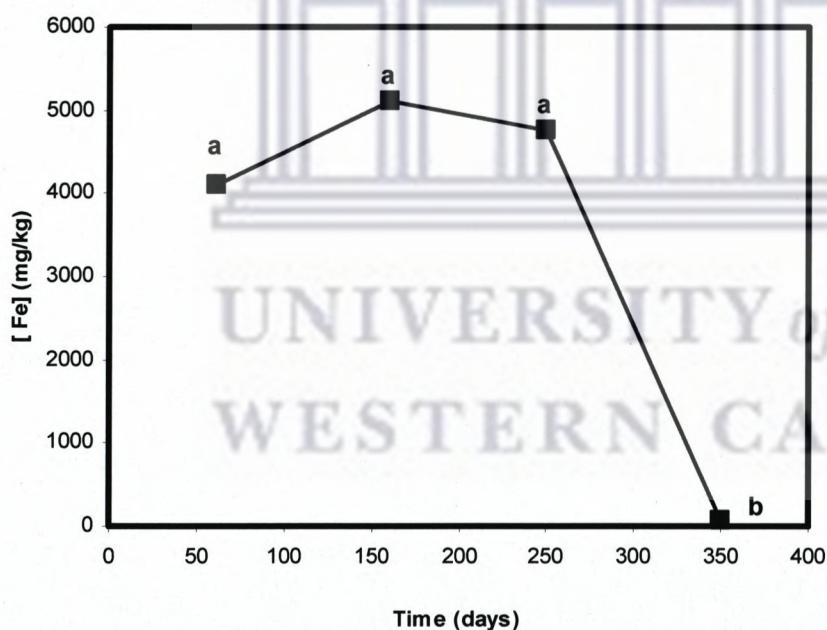

Figure 3.8 The variation in Fe in groundwater in the Franschhoek Trust Wetland in the 2008-2009 study period. Points marked with the same letter on the graph do not differ significantly ($p \leq 0.05$)

3.2.10 Bicarbonate

Bicarbonate (HCO_3^-) and carbonate (CO_3^{2-}) ions are mainly derived from the atmospheric and soil CO_2 and dissolution of carbonate rocks such as calcium carbonate (Krešić, 2007). The concentration of these ions is usually expressed as alkalinity (Dallas and Day, 2004). The proportion of HCO_3^- and CO_3^{2-} is dependant on pH, so that at a pH between 5.4 and 8.3 HCO_3^- is the predominant ion (Dallas and Day, 2004). During the period of investigation there were significant changes in HCO_3^- , and the concentration ranged between 27.94 and 102.07 mg/l (Fig. 3.9). The highest HCO_3^- concentration was measured on day 90 (December). In the period leading up to December there was a general increase in concentration, levels then gradually dropped reaching the lowest levels on day 350 (August) Compared to the rest of the anions it would appear that bicarbonate is the dominant anion in the system (Fig. 3.10 and Fig. 3.11). There is no water quality guideline for bicarbonate in South Africa.

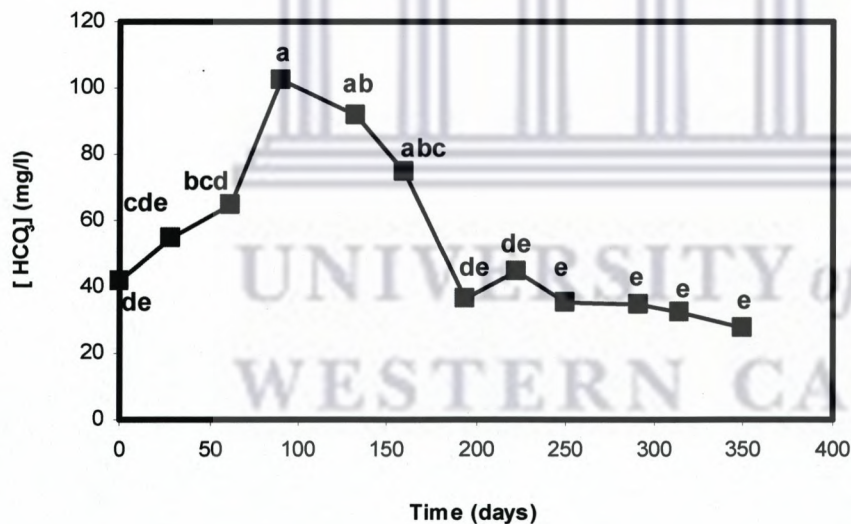

Figure 3.9 The variation in HCO_3^- in groundwater in the Franschhoek Trust Wetland in the 2008-2009 study period. Points marked with the same letter on the graph do not differ significantly ($p \leq 0.05$)

3.2.11 Chloride

Chloride (Cl^-) is an abundant anion in sea water and in inland water as well, particularly in South Africa (Dallas and Day, 2004). Chloride is involved in the oxygen evolving reactions of photosynthesis, cell division in leaves and shoots and osmotic and water balance of organisms

(Hopkins and Hüner, 2004). The main source of chloride in nature is soil and rocks, halite (salt) and brines (Minnesota Pollution Control Agency, 1999). Anthropogenic sources of Cl⁻ include fertilizers, human and animal waste and industrial application (Minnesota Pollution Control Agency, 1999).

There were significant changes in Cl⁻ concentration in groundwater over the study period mean concentrations ranged between 29.1 and 43.8 mg/l (Fig. 3.10). Cl⁻ concentrations fluctuated throughout the study period, the highest concentration was measured on day 222 (April). The continual fluctuation of Cl⁻ can be ascribed to it being both ubiquitous in nature and highly soluble (Hopkins and Hüner, 2004). So that even though it is readily taken up by plants it is rarely deficient. The average Cl⁻ concentration in the groundwater is below the target water quality range for irrigation water of 100mg/l (DWAF, 1996a).

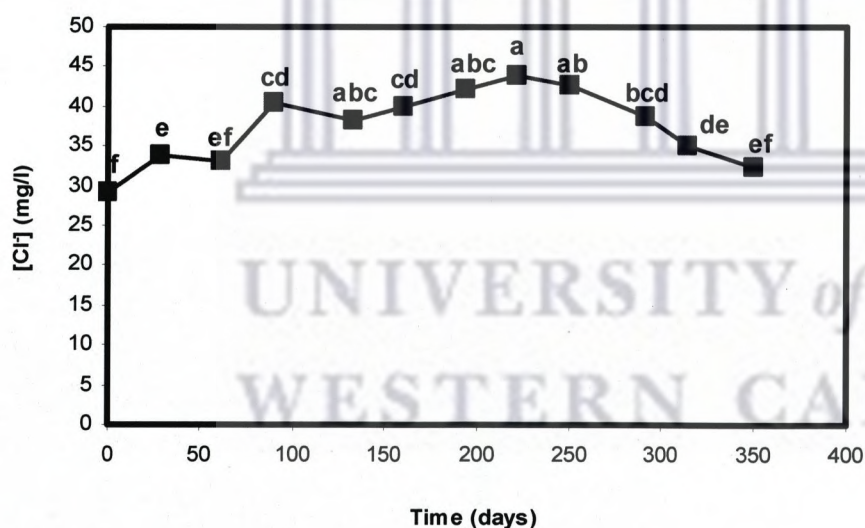

Figure 3.10 The variation in Cl⁻ in groundwater in the Franschoek Trust Wetland in the 2008-2009 study period. Points marked with the same letter on the graph do not differ significantly ($p \leq 0.05$)

3.2.12 Sulphate

In water sulphur largely occurs as the sulphate (SO₄²⁻) ion which is the oxidized form of sulphur (Dallas and Day, 2004). It is commonly found in water, air and soil and is not toxic at normal levels (Minnesota Pollution Control Agency, 1999). Sources of sulphate in water include

sulphate ores, shale's, industrial waste, and precipitation. Sulphate can also occur in groundwater due to the decomposition of organic matter and fertilizers (Minnesota Pollution Control Agency, 1999). According to Dallas and Day (2004) for the most part sulphate ions tend to occur in lower concentrations than either bicarbonate or chloride ions in natural waters.

This was true for this study site as well; sulphate concentrations in groundwater remained low with mean concentrations ranging between 4.2 and 8.6 mg/l (Fig. 3.11). There were some significant changes, in SO_4^{2-} concentrations, levels fluctuated throughout the study period with the highest concentration measured by September. There are no water quality guidelines for irrigation water or aquatic ecosystems for sulphate in South Africa.

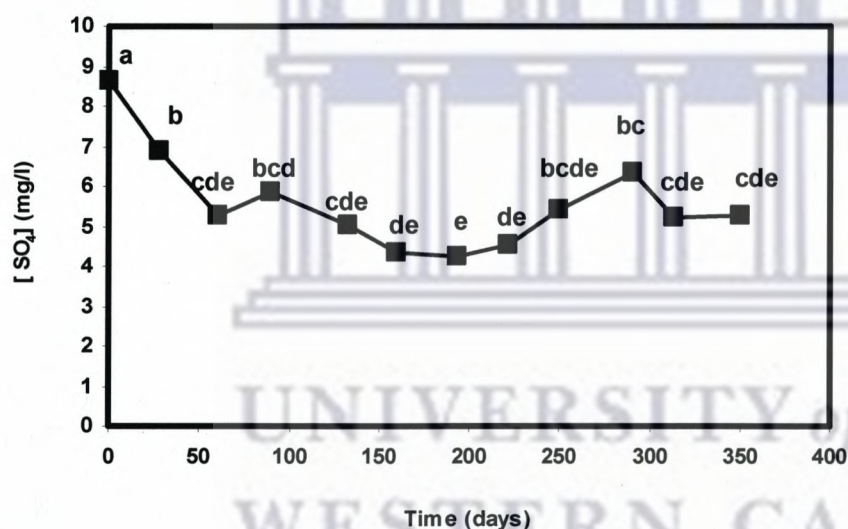

Figure 3.11 The variation in SO_4^{2-} in groundwater in the Franschhoek Trust Wetland in the 2008-2009 study period. Points marked with the same letter on the graph do not differ significantly ($p \leq 0.05$)

3.2.13 Nitrogen Measurements

Nitrogen (N) is ubiquitous in nature and is an essential component of proteins which includes enzymes which catalyse biochemical processes (Dallas and Day, 2004). Nitrogen is also a constituent of cells occurring in compounds such as chlorophyll, the nucleic acids DNA and RNA, enzymes and the protein that holds cells together. Nitrogen may enter a wetland system in a number of ways. Sources include: livestock dung, birds using the wetland as a roost or feeding

area, runoff from anthropogenic activities such as farming, runoff from the landscape, rainfall, atmospheric deposition, nitrogen fixation, and decomposition of plant material, direct fixation and diffusion (Palmer *et al* 2002). Inorganic nitrogen can take many forms, but common water quality test include ammonia (NH₃), ammonium (NH₄⁺), nitrites (NO₂⁻) and nitrates (NO₃⁻).

3.2.13.1 Ammonium

Ammonium (NH₄⁺) is usually present in surface and groundwater due to decomposition of nitrogenous organic matter (Dallas and Day 2004). At low to medium pH values, the ammonium ion dominates, but as pH increases ammonia is formed.

In the study period NH₄⁺ concentrations showed significant changes with mean concentrations ranging between 0.5 to 11.9 mg/l (Fig. 3.12). Results show a general increase in NH₄⁺ in the summer months with the highest concentrations measured on day 133 (January). Concentrations then declined towards winter with almost an almost complete washout of NH₄⁺ in May to August (the months associated with the most precipitation events). The peak of ammonia in the summer months can be attributed to lowering of water tables leading to increased decomposition of organic matter during which large amounts of ammonia can be released. Ammonium concentrations for groundwater exceeded the target water quality range for aquatic ecosystems of 7 mg/l but did not exceed the chronic effect value of 15mg/l (DWAF, 1996b).

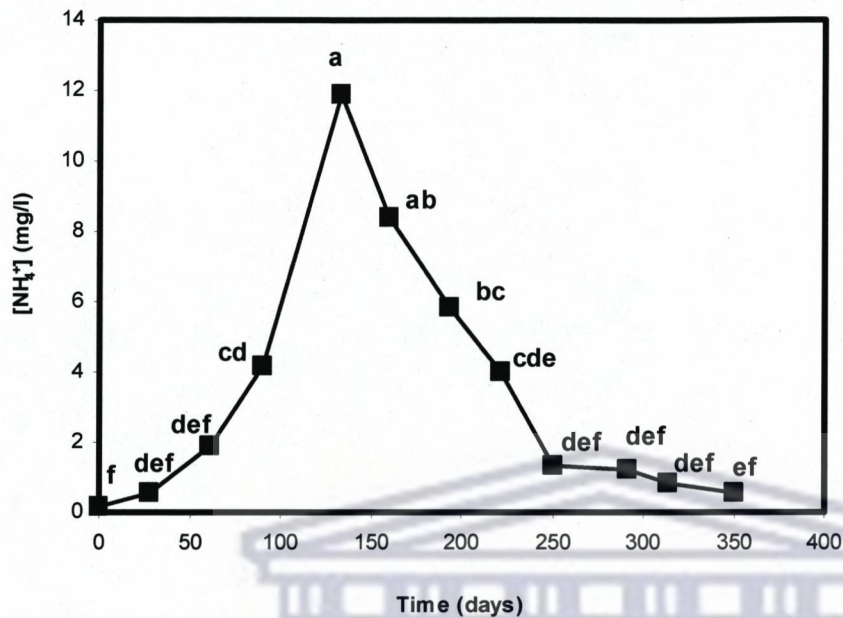

Figure 3.12 The variation in ammonium in groundwater in the Franschhoek Trust Wetland over the 2008-2009 study period. Points marked with the same letter on the graph do not differ significantly ($p \leq 0.05$)

3.2.13.2 Nitrate

According to Palmer *et al* (2002) the nitrogen present in groundwater will largely be in the form of nitrates due to the nitrification processes. Nitrates may enter water through fertilizers, agricultural run-off etc. (Dallas and Day 2004). Although not abundant in freshwater, nitrate may be found in high concentrations in groundwater. At pH levels of 5.5 Nitrogen (in the form of nitrates) is made available to plants. During the study period there was one significant change in nitrate level, with mean NO_3^- levels ranging between 1.063 and 5.938 (Fig. 3.13). On day 90 (December) the highest nitrate levels were recorded, during this time of year there is little to no rainfall, the high levels seen may be due to the sample consisting essentially out of groundwater. The nitrate concentration was generally within the target water quality range of 5 mg/l for irrigation water (DWAF, 1996a).

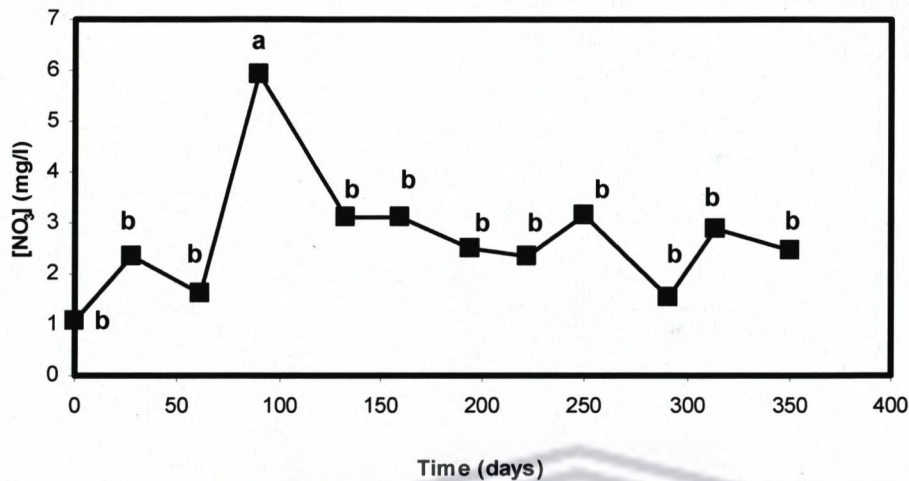

Figure 3.13 The variation in nitrate in groundwater in the Franschhoek Trust Wetland in the 2008-2009 study period. Points marked with the same letter on the graph do not differ significantly ($p \leq 0.05$)

3.2.13.3 Nitrite

According to Dallas and Day (2004) nitrite (NO_2^-) is a naturally occurring anion. It is an intermediary compound which is formed during the aerobic nitrification and anaerobic denitrification process (Van Cleemput and Baert, 1984). Soil pH plays a large role in nitrite decomposition (under acidic pH (< 5.5) nitrous oxides spontaneously decompose to NO and NO_2^-) (Van Cleemput and Samater, 1996). According to Van Cleemput and Baert (1984) nitrite rarely accumulates in soils and aquatic systems, and will only do so if agricultural processes such as ammonium fertilization, soil or water pH, organic matter content, temperature, moisture content and soil fertilizer geometry promote alkaline conditions.

Results show significant changes in mean NO_2^- concentration over the study period (Fig. 3.14). Concentrations ranged between 0 and 0.95 mg/l with the highest levels recorded on day 90 (December), concentrations gradually declined hereafter with NO_2^- completely washed out in May to August by winter rain. Nitrite concentrations remained low throughout the year and well below the target water quality range for irrigation water of 5 mg/l (DWAF, 1996a).

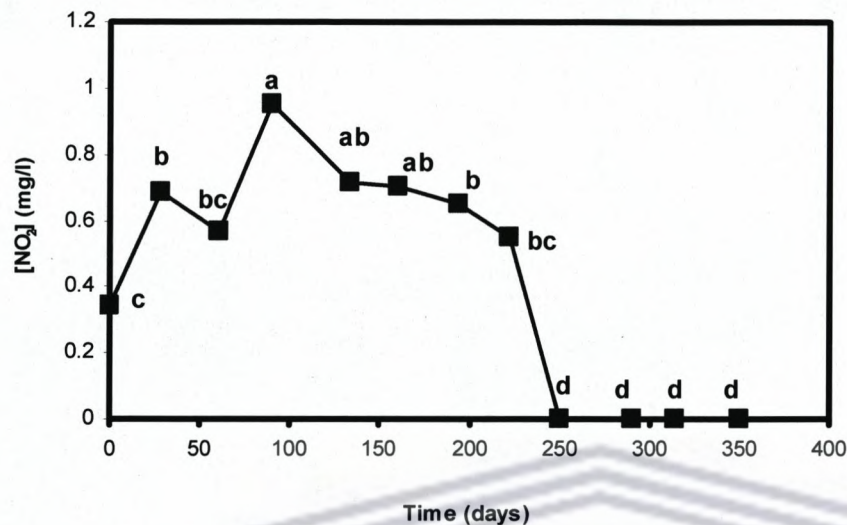

Figure 3.14 The variation in nitrite in groundwater in the Franschhoek Trust Wetland in the 2008-2009 study period. Points marked with the same letter on the graph do not differ significantly ($p \leq 0.05$)

3.2.14 Phosphorus Measurement

Phosphorus in the form of phosphates can make its way into a wetland via runoff and stream flow from sources such as livestock, birds which use wetland as a roost or feeding area, surface runoff from anthropogenic sources such as farming and mining, runoff from the landscape, rainfall, and wind inlets (Palmer *et al* 2002). The release of P from soil into overlying water is dependant on both physical and biological factors such as temperature, pore water soluble P concentration and microbial activity (Newman and Pietro, 2001). However according to Song *et al* (2007) pH and redox potentials might be the driving force. In Palmer *et al* (2002) it is postulated that a decrease in pH due to biological formation of organic acids, nitrates or sulphates will result in a release of phosphate. Whereas the shift from aerobic to anaerobic conditions as a result of flooding can also release previously adsorbed P due to the reduction of ferric iron (Fe^{3+}) into the more soluble ferrous form Fe^{2+} (Newman and Pietro, 2001; Palmer *et al* 2002). Both of these processes are thus very dependant on water level fluctuations.

Results show significant changes in P concentration over the study period, mean concentrations ranged between 0.045 and 0.65 mg/l (Fig. 3.15). The highest levels of P were measured on day 61 (Nov) followed by a significant drop in the following month. By day 133 (January) P concentrations had increased significantly and they then dropped to the original level by day 194,

hereafter levels remained low with no significant changes throughout the rest of the study period. Results suggest that there are little to no influence from anthropogenic P sources as levels are low in winter when runoff is high. The phosphorus concentration in the wetland fell within the target water quality range for aquatic ecosystems of <5mg/l (DWAF, 1996b). According to (DWAF, 1996b) water falling within this water quality range is representative of oligotrophic conditions; usually moderate levels of species diversity; usually low productivity with rapid nutrient cycling and no nuisance growth of aquatic plants.

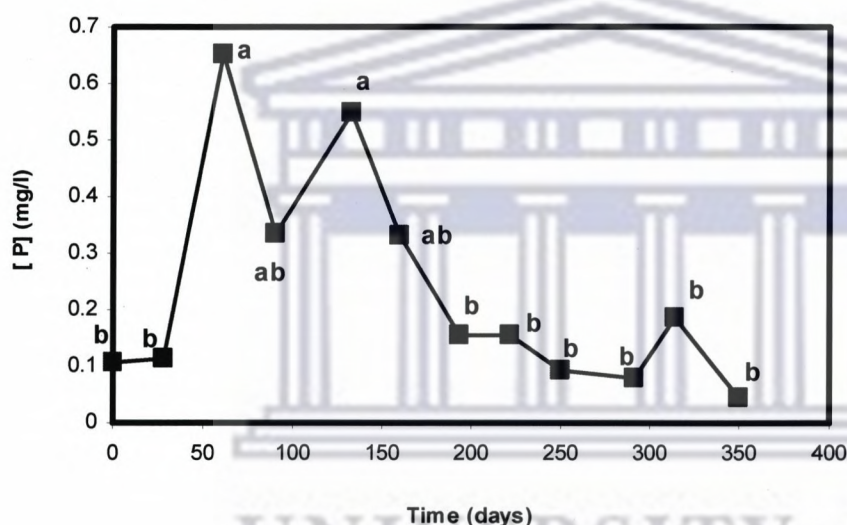

Figure 3.15 The variation in P in groundwater in the Franschhoek Trust Wetland in the 2008-2009 study period. Points marked with the same letter on the graph do not differ significantly ($p \leq 0.05$)

3.2.15 Surface Water

Four surface water inlets and one surface water outlet were identified within the wetland area. The surface water samples were tested for the same parameters as groundwater, with the addition of dissolved oxygen. Dissolved oxygen, is represented as the volume of oxygen contained in water. Increasing temperature and salinity, respiration of aquatic organisms, decomposition of organic material and chemical breakdown of pollutants all cause a decrease in dissolved oxygen (Malan and Day, 2005). Increases in dissolved oxygen can be attributed to faster moving water, lower temperature and salinity. The World Health Organization recommends dissolved oxygen

content of 5mg/l or above. All surface water inlets dried up during the low rainfall summer period between January and April. Inlet 1 is a ditch which has its source from farmland close by, and runs into the smaller part of the wetland identified as site C (Fig.3.16). Inlet 2 is a ditch running into the bigger part of the wetland identified as site A (Fig. 3.16), its source is also agricultural in nature but must be from farmland situated further away. Inlet 3 runs into the bigger wetland marked as A and have its source in road or landscape run off making it diffuse in nature. Inlet 4 runs into the wetland part identified as A of the wetland and its source was traced to the Wemmershoek River situated further up in the catchment (Fig. 3.16).

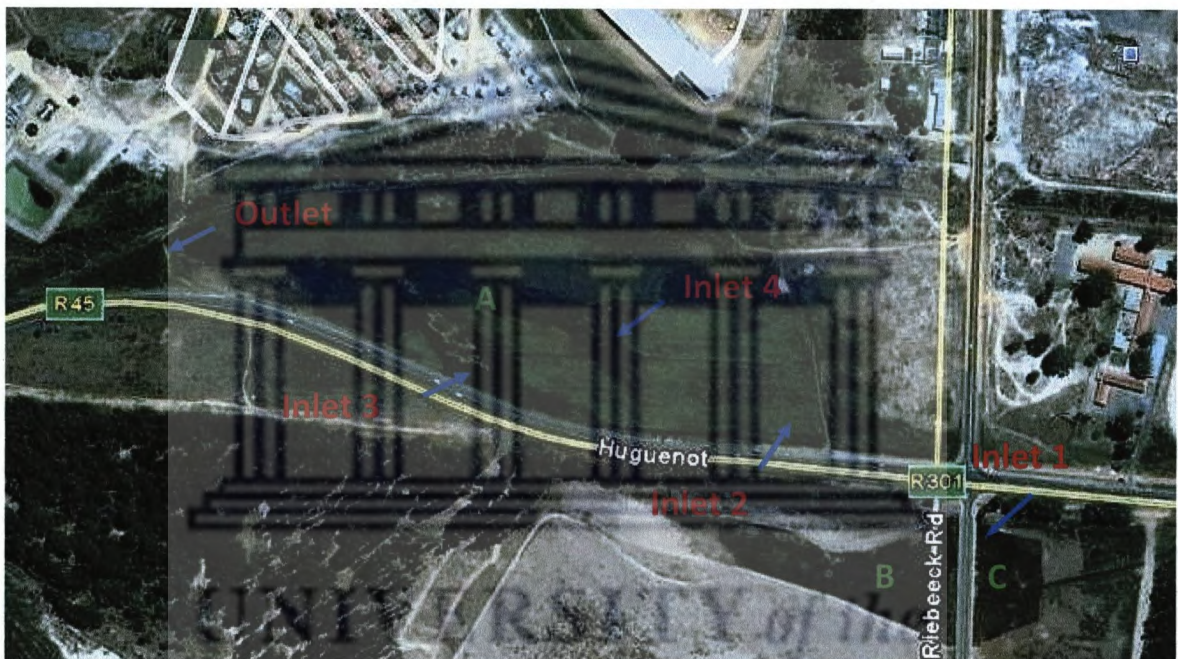

Figure 3.16 An aerial image showing the wetland components (indicated by A, B and C) as well as surface water input and output sites.

The mean concentrations shown in table 3.4 are representative of 12 months of sampling, as a result of seasonal fluctuations during the year standard deviations are quite high. During the study period nitrate concentration of inlet 1 was significantly higher than the outlet (Table 3.4). The source of nitrates is likely to be from fertilizers associated with farming activities. The sulphate concentrations of inlet 3 were significantly higher than that of the output (Table 3.4). Generally improved water quality of the outlet site indicates interaction with groundwater and the organisms in the wetland.

Table 3.4 Mean and standard deviation of water parameters for surface water inlet and outlet sites within the Franschhoek Trust Wetland for the study period 2008-2009

Parameters	Inlet 1 (n = 8)		Inlet 2 (n = 6)		Inlet 3 (n = 7)		Inlet 4 (n = 6)		Outlet (n=8)	
	Mean	Std. dev.	Mean	Std. dev.	Mean	Std. dev.	Mean	Std. dev.	Mean	Std. dev.
Temp °C	18.80	2.00	16.87	3.35	16.36	4.36	16.18	3.67	15.46	4.21
pH	6.46	0.36	6.56	0.31	6.43	0.27	6.50	0.26	6.40	0.28
EC	236.30	70.79	198.80	120.95	214.00	65.85	187.80	92.90	232.50	121.1
Nitrate mg/l	9.85	7.10	1.42	1.81	5.25	3.30	1.83	3.25	0.87	1.12
Nitrite mg/l	0.22	0.28	0.12	0.23	0.30	0.30	0.05	0.12	0.20	0.29
Ammonium mg/l	0.28	0.58	0.08	0.18	0.13	0.23	0.01	0.04	0.30	0.80
Ca mg/l	1.07	0.20	0.94	0.55	1.07	0.43	0.73	0.23	0.76	0.14
Na mg/l	1.42	0.26	1.41	0.35	1.67	0.16	1.57	0.59	1.62	0.53
K mg/l	3.80	1.38	2.67	0.72	4.88	4.16	2.56	1.08	2.32	0.73
Mg mg/l	0.57	0.15	0.38	0.14	0.58	0.09	0.34	0.07	0.44	0.11
Fe mg/l	0.29	0.32	1.27	2.85	0.15	0.12	0.49	0.37	0.82	1.54
P mg/l	0.03	0.02	0.06	0.04	0.05	0.05	0.06	0.03	0.06	0.05
SO ₄ ²⁻ mg/l	12.84	3.34	7.05	4.14	13.12	0.74	7.65	5.19	7.48	2.43
Cl ⁻ mg/l	25.33	4.91	25.17	7.38	31.70	5.81	25.7	10.94	27.42	11.54
HCO ₃ ⁻ mg/l	18.94	3.92	44.40	33.11	28.17	5.58	22.71	6.38	27.75	8.86
Dissolved oxygen mg/l	7.09	2.98	6.06	3.00	7.52	2.37	5.74	2.13	5.87	1.74

3.2.16 Seasonal trend summary

Results from the study showed that the groundwater level fluctuation in the wetland is negligible with average water level fluctuation at 0.58cm. Water temperature showed a clear seasonal trend, increasing in summer and decreasing in winter. It was found that bicarbonate, potassium, nitrate, nitrite, ammonium show a similar seasonal trend of concentration with the highest values reached in summer (Dec-Jan) and then attenuating towards winter. Ca and P concentrations peaked in late spring (November) and then decreased toward winter as well. Magnesium and sodium did not show any distinct seasonal behaviour. Iron and sulphate had their highest concentrations in September; iron levels dropped significantly thereafter and remained low throughout the rest of the year, whereas sulphate fluctuated continuously throughout the year.

3.2.17 Principal Component Analysis

3.2.17.1 Major cations and anions in groundwater; chemical relationship and source

The principal component analysis (PCA) in Figure 3.17 arranged the main water quality parameters according to their chemical relationship and source. In the variable loading plot Axis F1 explained 72.21% of the variance between the plots, whereas F2 explained 13.35% of the variance making up a combined 85.56% variance. As the first factor explained the majority of the variance, this shows that the data is almost one dimensional i.e. many parameters tend to consistently measure a common underlying concept. The parameters which are contributing most toward the overall chemistry of water are sodium (0.997), chloride (0.989) and bicarbonate (0.955) in the deeper groundwater and phosphorus (0.970), and ammonium (0.952) in shallow groundwater. Results show strong positive correlation between most of the ions. The strongest positive correlation was found between Cl^- and Na (9.90). The next strongest correlation was between P and ammonium (0.989) followed by Cl^- and HCO_3^- (0.979) and HCO_3^- and EC (0.979). The strongest negative correlation was noted between pH and Fe (-0.922). The PCA highlights the importance of firstly Na and Cl^- as well as Cl^- and HCO_3^- in the system and may interpreted as the degree of salinization of the groundwater. According to Jolly *et al* (2008) periods of higher salinity is a natural phenomenon in semi arid zones, which may be attributed to

high evaporative conditions and variability of inflows which provide dilution and flushing of stored salts during hot dry summers. In this wetland all surface water inlets completely dried up during the summer months so this is highly probable. The salts contributing towards salinity are usually water-borne and consist out of calcium, sodium and magnesium in combination with bicarbonate, sulphate and chloride which are all positively correlated in the system except for sulphate. The strong negative correlation between iron and pH is consistent with the reduced conditions which take place when soils are waterlogged. The strong positive correlation between phosphorus and ammonium may be explained by both of their availability being highly dependant on water level and therefore would follow similar trends.

The factor score plots shows that the shallow groundwater of 1 m was dominated by, iron, ammonium and phosphorus, and was most influenced by temperature variation. The chemistry of the surface samples most resembled that of the shallow groundwater. This is expected since at a depth of one meter, surface water is able to mix with and influence groundwater chemistry more readily than at deeper depths. Higher concentrations of Fe and Ca are common in shallow groundwater. This is due to deeper sediment and rock containing higher levels of sodium, which replaces calcium and iron during ion exchange processes (Sutton, 2001). Ammonium enters wetlands mainly through surface runoff, or decomposition of nitrogenous organic matter (Dallas and Day, 2004). It will therefore be most dominant in shallow groundwater. High nitrate in shallow groundwater can be due to either mixing of surface water containing fertilizers or agricultural runoff with the shallow groundwater (Dallas and Day, 2004) or through the nitrification of nitrogen into nitrates which usually take place within the unsaturated soil mass (Palmer *et al* 2002). Groundwater in the shallower piezometer will be most affected by seasonal temperature variation, warming up in summer and cooling down in winter (Younger, 2006). According to Palmer *et al* (2002) phosphate enters wetlands primarily through runoff and stream flow, with groundwater interflow unlikely to contribute as most phosphates will be retained in the soil matrix. Phosphorus is therefore most dominant in shallow groundwater. Sulphate seems to be entering the wetland from atmospheric sources and /or runoff as it is most closely associated with surface water inlets. The groundwater at a depth of 1.5m and 2m had higher EC due to higher concentrations of potassium, nitrite, bicarbonate, and chloride, sodium and magnesium. The depth from surface plays an important role in the quality of the water. Groundwater in the deeper parts of the aquifer moves more slowly through the sediments,

making it more mineralized. This is apparent in the loading plot with groundwater at a depth of 1.5 and 2 m supporting more minerals and thereby contributing more towards electrical conductivity. It is clear that the dissolution of minerals in soil and bedrock material is the main source of these minerals. The chemistry of the groundwater at greater depth was most similar to what was measured at the outlet. This suggests that from its point of entry to the outflow zone, water is undergoing transformation due to groundwater discharge. From the factor plot pH is most closely correlated to the outlet water. It is well known that wetlands act as buffer zones with a neutralizing capacity which prevents water from becoming too acidic or basic (Cirimo and Driscoll, 1993; Ito *et.al.* 2005; Mayes *et.al.* 2006).



UNIVERSITY *of the*
WESTERN CAPE

Variables (axes F1 and F2: 85.56 %)

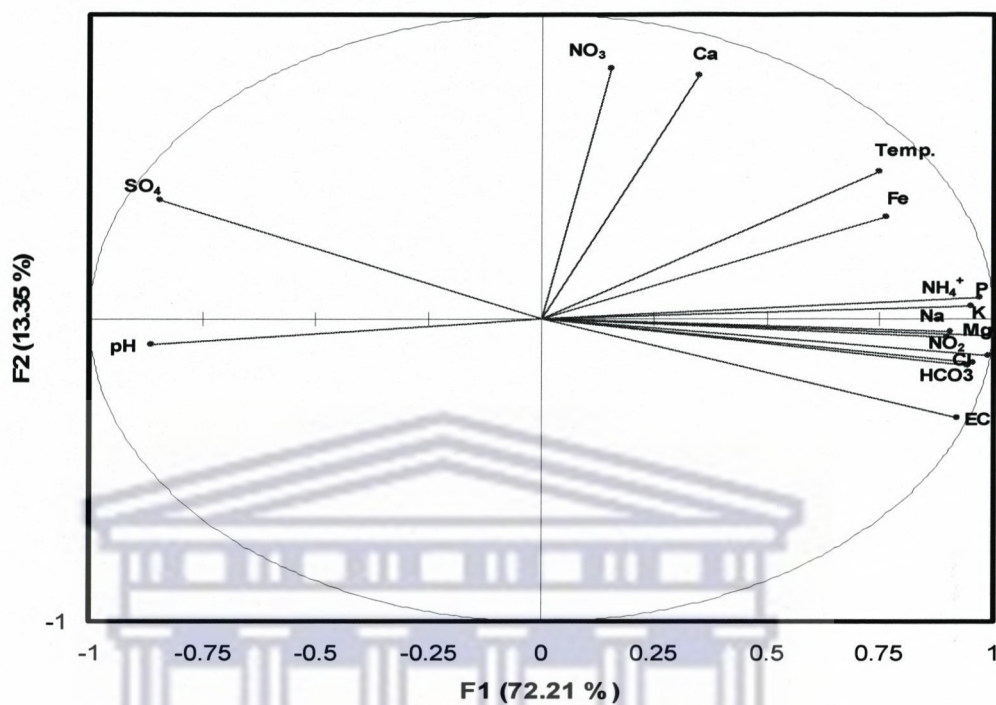

Observations (axes F1 and F2: 85.56 %)

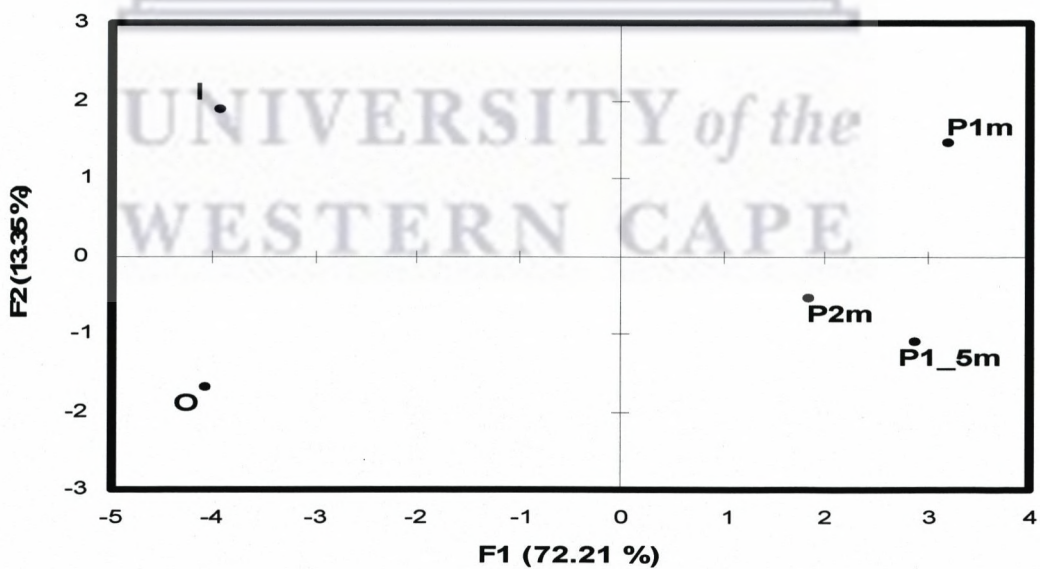

Figure 3.17 Principal component analysis (PCA) of main water chemistry parameters tested for based on chemical relationship and water source

3.2.17.2 Relationship between groundwater and vegetation

A principal component analysis was also done on elevation (m), average water level (m), maximum water level (m) and piezometer position (Fig. 3.18). In the biplot axis F1 accounted for 99.89 % of the variance whilst F2 accounted for 0.50% of the variance measured.

The piezometers in the upper left and right part of the diagram represent the two extremes of elevation within the wetland with the piezometers on the right side occupying the high laying areas, and P4 situated at the highest elevation. The piezometers on the left side of the diagram occupy the lowest laying areas in the wetland with P3 at the lowest elevation. The bottom left and right part of the diagram has clustered together those piezometers closely associated with maximum and average water level. P14 and P10 are most closely associated with maximum water level; these piezometers are situated in a part of the wetland with a higher outlet so water remains in the wetland for longer periods of time. P13 had the highest maximum water level in the high laying areas with an outlet. P1 and P5 had the highest maximum water level in the lower laying areas.

A second principal component analysis was done with the same parameters as Figure 3.18 but this time including vegetation. In this biplot F1 accounted for 19.83% of the variance whilst F2 accounted for 13.79% bringing the total variance to 33.61% (Fig 3.19) The plant species able to withstand periods of prolonged inundation, such as the *Juncus* species and *Typha capensis* cluster together in the lower right and left corners of the diagram. The species on the right is subjected to flooding due to longer standing water levels, and the ones in the right corner, due to increased frequency of flooding as a result of low elevation. *Persicaria decipiens*, *Acacia saligna* and *Passerina sp.* do not enjoy high abundance as they are not typical wetland plants and are unable to cope with oxygen stress during flooding. In the upper right corner of the diagram are those species which occur at higher elevation and receives occasional flooding of short duration, without permanent flooding and consist out of the bulb specie *Watsonia meriana* and wetland grasses such as *Paspalum urvillei* and *Pennisetum macrourum*. Of the three identified sites this site has highest species richness. The upper left corner contains the intermediate species such as *Zantedeschia aethiopica*, *Cyperus denudatus* and *Hydrocotyle verticilata* which are able to grow both in the shallow water of the lower laying areas and high elevation sites. P1 has the

highest measured elevation of the lower laying areas and is therefore closely associated with these species. This is a classic example of microtopography creating a variety of environmental conditions that favour the unique requirement of many different species of marsh plants. .

Bledsoe and Shear (2000) found that an elevation difference as small as 10 cm resulted in a 20% change in flooding frequency, leading to differences in wetness, oxygen and nutrient availability. According to the PCA plot there are 3 hydrologic zones within the wetland:

- Rises or high zones where soils are rarely or never flooded, but the groundwater table occurs at a shallow depth throughout the year occupied by perennials and grasses.
- Hollows or low zones where soils experience intermittently flooded and dried conditions occupied by *Typha* and *Prionium*.
- The submerged zone: The construction of the road has separated the wetlands into 3 parts (See Fig. 3.16). The road has influenced the height and seasonal dynamics of the water table in parts B and C, due to slower moving water which tend to dam up. As a result the site is permanently water saturated and is occupied predominantly by *Juncus* species.



UNIVERSITY of the
WESTERN CAPE

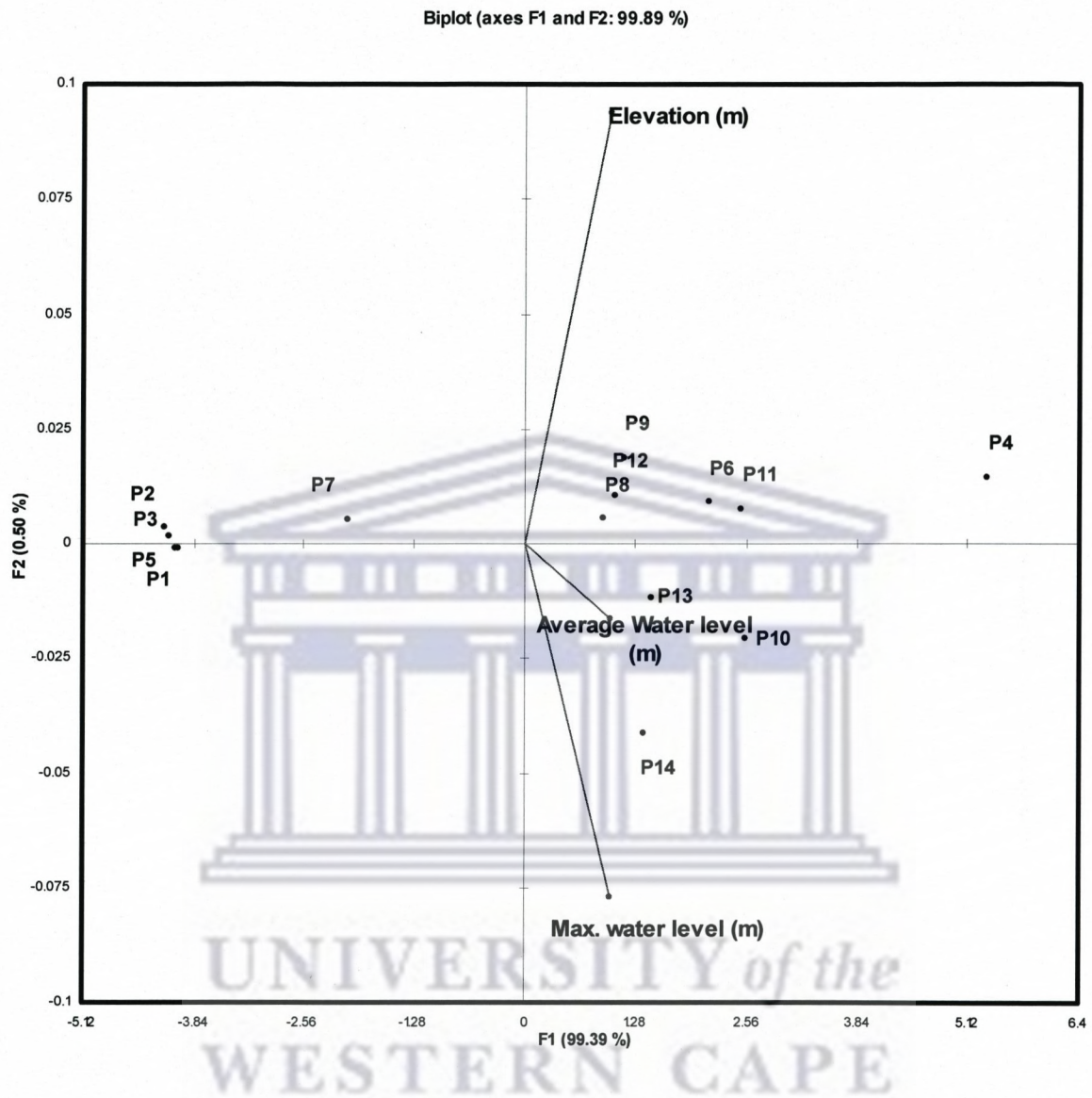

Figure 3.18 Principal component analyses on distribution of piezometers, elevation (m), average and maximum groundwater level (m). (The abbreviation P is for piezometer 1-14)

Biplot (axes F1 and F2: 33.61 %)

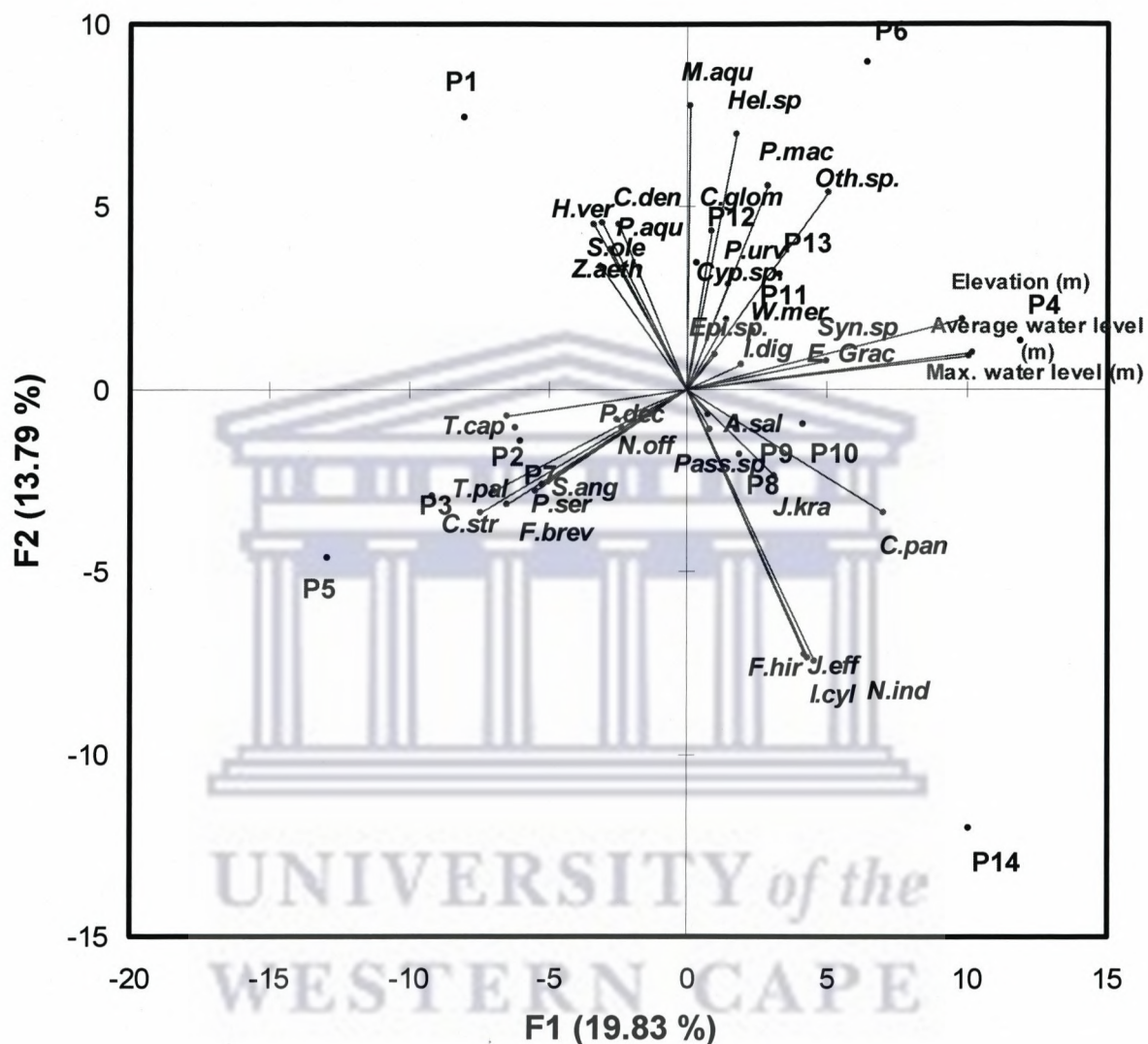

Figure 3.19 Principal component analysis (PCA) of vegetation samples recorded in 5x5m plots around each piezometer along with elevation (m), average water level (m) and maximum water level (m). Explanation of species abbreviations: *A.Sal*-*Acacia Saligna*, *C.pan*-*Calopsis paniculata*, *C.glom*-*Carpha glomerata*, *C.stro*-*Clifortia strobilifera*, *C.den*-*Cyperus denudatus*, *Epi.sp.*-*Epishoenus species*, *E.Grac*-*Epishoenus gracilis*, *F.hir*-*Ficinia hersuta*, *Hel.sp* *Helichrysum species*, *H.ver*-*Hydrocotyle verticillata*, *I.dig*-*Isolepus digitata*, *J.eff*-*Juncus effuses*, *J.kra*-*Juncus Kraussii*, *M.aqu*-*Mentha aquatica*, *N.ind*-*Nymphoides indica*, *Oth.sp.*-*Othonna species*, *P.urv*-*Paspalum urvillei*, *Pass.sp.*-*Passerina species*, *P.mac*-*Pennisetum macrourum*, *P.dec*-*Persicaria decipiens*, *P.ser*-*Prionium serratum*, *P.aqu*-*Pteridium aquilinum*, *R.cum*-*Rubus cumeifolius*, *S.ang*-*Searsia angustifolia*, *S.ole*-*Sonchus oleraceus*, *Syn.*-*Syncarpha species*, *T.pat*-*Thylypteris palustris*, *T.cap*-*Typha capenis*, *W.mer*-*Watsonia meriana*, *Z.aeth*-*Zantedeschia aethiopica*

3.2.18 Water chemistry of the three hydrologic zones

The difference in hydrologic regime is reflected in the water chemistry of the three identified sites and there are notable differences in the average concentration for the parameters measured (Table 3.5).

Table 3.5 Mean and standard deviations of water quality parameters measured in the three identified sites within the Franschhoek Trust Wetland for the study period 2008-2009

Parameters	Hollows (n=169)		Submerged (n=106)		High sites (n=88)	
	Mean	Std. dev.	Mean	Std.dev.	Mean	Std.dev.
Temp °C	17.41	2.51	17.85	2.75	18.02	3.57
pH	6.18	0.64	6.26	0.54	6.13	0.38
EC	295.68	173.50	352.63	307.20	296.78	145.30
Nitrate mg/l	1.78	2.50	5.14	9.02	1.78	0.97
Nitrite mg/l	0.46	0.60	0.34	0.79	0.45	0.27
Ammonium mg/l	1.59	4.48	4.27	6.25	9.11	14.58
Ca mg/l	1.46	4.63	0.69	0.48	0.59	0.55
Na mg/l	2.31	1.17	2.12	0.62	2.05	0.55
K mg/l	6.82	7.66	4.04	0.48	3.06	3.25
Mg mg/l	0.45	0.25	0.73	0.57	0.37	0.17
Fe mg/l	0.95	2.49	6.84	42.4	135.3	5.60
P mg/l	0.18	0.80	0.40	0.44	0.24	0.90
SO ₄ ²⁻ mg/l	5.01	3.97	6.24	5.09	3.01	1.30
Cl ⁻ mg/l	41.34	17.06	38.10	8.34	34.28	8.3
HCO ₃ ⁻ mg/l	52.45	39.6	59.01	108.39	57.71	56.89

Water samples were collected monthly for a 12 month period, the high standard deviation can be attributed to seasonal fluctuations of concentrations especially during summer and winter (Section 3.1.16).

All three sites showed similar mean pH which could be indicating a similar water source. Results show the high sites which come in contact only with the shallow groundwater has comparably higher mean temperature, iron and ammonium which coincide with the chemistry of the shallow one meter piezometers (Fig. 3.17). The submerged sites has comparably higher mean EC, phosphorus, magnesium, nitrate, sulphate and bicarbonate concentrations then the other two sites. The high EC during certain parts of the year may be attributed to the higher outlet causing water to remain in the wetland for longer periods so that nutrients may accumulate due to increased evapotranspiration fluxes. Higher average nitrate levels may be due to contribution from surface water inputs during periods of increased runoff (See Table 3.4). The hollow sites has on average much lower concentrations then the other two sites; this might be due to this site being very close to the outlet which flushes much of the nutrients out of the system. Higher mean calcium, sodium and potassium may be attributed to high concentrations of these ions in the soil of hollow sites during periods of lower water levels (Table 3.7).

3.3 Soil

3.3.1 pH measurements

The pH of the soil is very important, as the soil solution carries all the major ions important for plant growth. As pH levels oscillate these nutrients become more or less available to plants. According to Snyder (2002) the pH of acidic soils will increase after being flooded, and the pH of an alkaline soil will decrease after inundation. The change in pH may take several weeks depending on soil type, organic matter, temperature and microbial activity. In the study site mean soil pH ranged between 5.08 and 5.5 (Fig 3.20). Soil pH showed significant variation, decreasing from 5.39 in late spring to 5.0 in late summer and early winter and returning to 5.56 when moving into spring (Fig. 3.20). The fluctuation in pH may be ascribed to the flooding of soil during the rainy winter months. Although the pH in groundwater was slightly higher then that of the soil it displayed similar trends with the highest pH recorded during August.

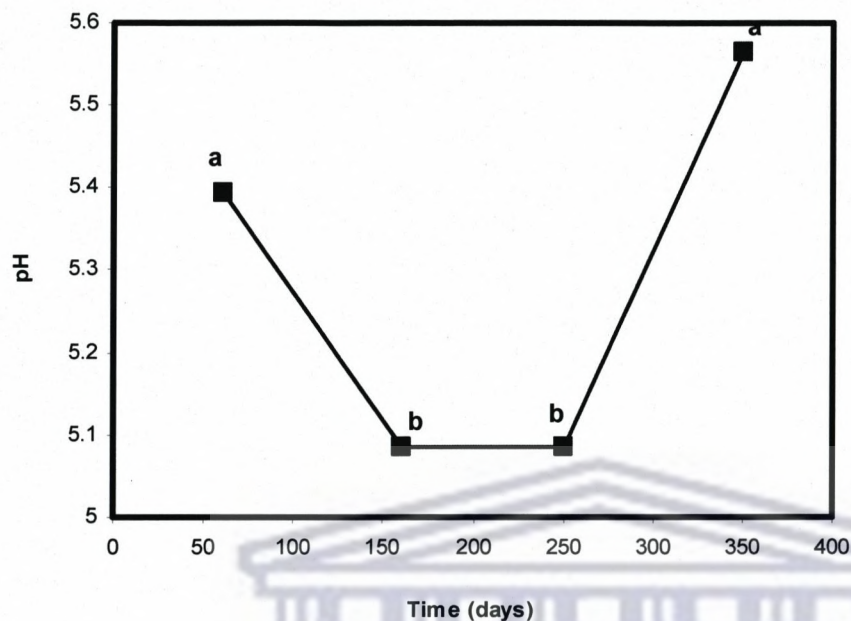

Figure 3.20 The variation in pH measurement in soil from the Franschoek Trust Wetland over the 2008-2009 study period. Points marked with the same letter on the graph do not differ significantly ($p \leq 0.05$)

3.3.2 EC measurements

The electrical conductivity of a soil provides insight into the nutrient content of the soil. During the study period average soil EC values declined steadily from 206.51 to 122.43 $\mu\text{S}/\text{cm}$ (Fig. 3.21). This means that the soil available nutrients decreased as we moved toward winter.

According to Marschner (1995) nutrient availability in the top soil declines steeply during the growing season, and in Mediterranean type climates such as this, most plant growth takes place in winter and spring. Groundwater EC and soil EC was similar in November, but with the onset of the rainy season groundwater EC increased while soil EC decreased.

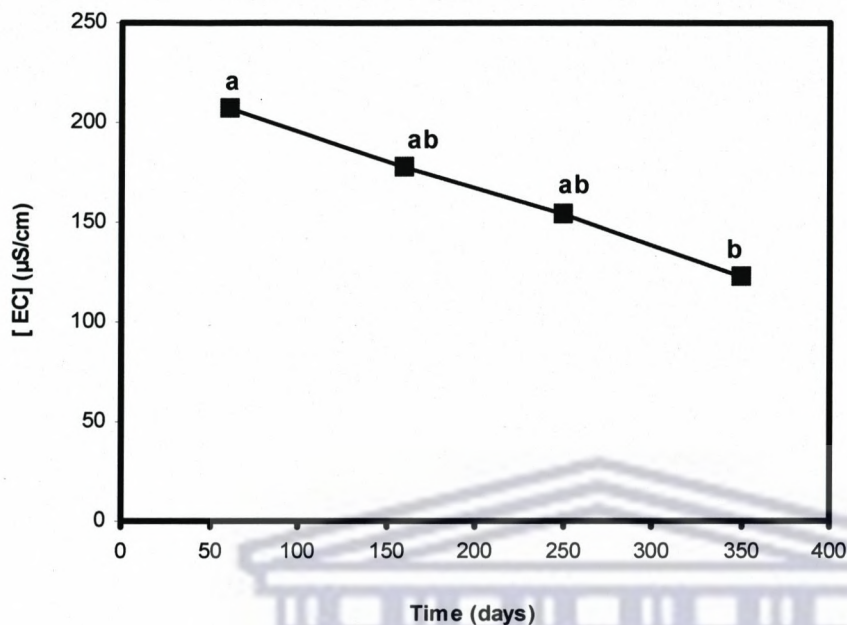

Figure 3.21 The variation in electrical conductivity in soil from the Franschoek Trust Wetland over the 2008-2009 study period. Points marked with the same letter on the graph do not differ significantly ($p \leq 0.05$)

3.3.3 Magnesium

There was significant variation in soil Mg over time, concentrations ranged from 2.5 to 35 mg/kg with a marked decrease in the last sampling month (Fig. 3.22). According to Spectrum Analytic (2010) this can be ascribed to cation competition, where high concentrations of either K or Ca in soil (as is the case here with potassium (Fig.3.24) will result in a decreased availability of Mg. They seem to share an inverse relationship with Mg in groundwater decreasing with increasing soil Mg and vice versa. The Mg concentration measured in the wetland is well above the average content of mineral elements in soil of 5 mg/kg, plants require between 1-3mg /kg of magnesium in order to function optimally(Larcher, 2003).

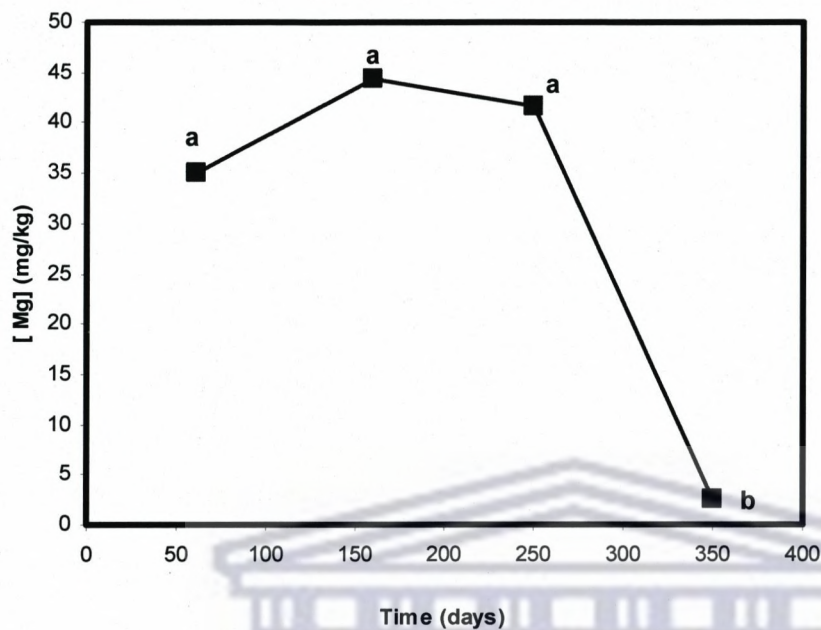

Figure 3.22 The variation in Mg in soil in the Franschoek Trust Wetland over the 2008-2009 studies period. Points marked with the same letter on the graph do not differ significantly ($p \leq 0.05$)

3.3.4 Sodium

There were significant changes in soil Na concentration during the study period (Fig.3.23). Concentrations ranged between 13.62 and 21.71 mg/kg. The only significant increase found in soil Na levels occurred by day 350 (August). The increases in sodium can be due to cation competition, according to Suthersan and Payne (2005) sodium is known to displace Ca and Mg during cation exchange. An inverse relationship was noted when comparing concentrations in groundwater and soil. The Na concentration measured in the wetland is well above the average content of mineral elements in soil of 5 mg/kg (Larcher, 2003).

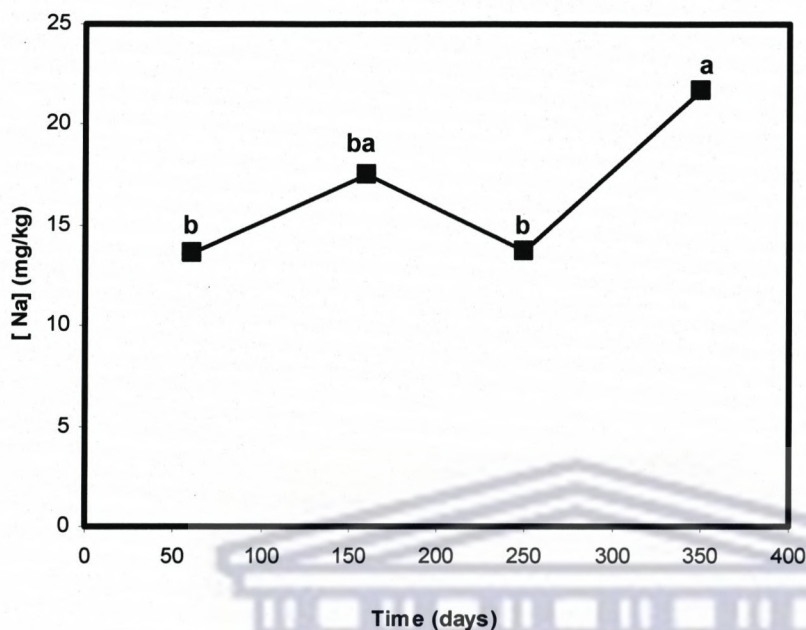

Figure 3.23 The variation in Na in soil in the Franschoek Trust Wetland over the 2008-2009 study period. Points marked with the same letter on the graph do not differ significantly ($p \leq 0.05$)

3.3.5 Potassium

There was significant variation in soil K over time mean concentrations ranged from 471.9 to 1899.7 mg/kg with a marked increase in the last sampling month (Fig. 3.24). The increase in K can be attributed to increased biological activity and formation of colloidal humus leading to an increase in Cation Exchange Capacity (CEC). In soils K increased significantly in Aug whilst in groundwater the lowest levels were measured in this month. The K concentration measured in the wetland is well above the average content of mineral elements in soil of 14 mg/kg, on average plants require 15-25 mg/kg potassium to function optimally (Larcher, 2003).

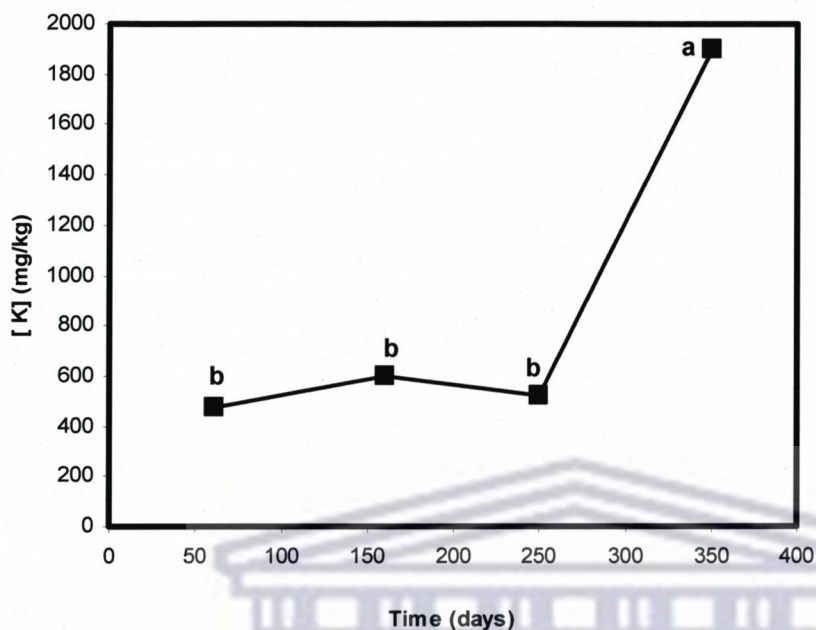

Figure 3.24 The variation in K in soil in the Franschoek Trust Wetland in the 2008-2009 study period. Points marked with the same letter on the graph do not differ significantly ($p \leq 0.05$)

3.3.6 Iron

The iron content of soil is dependent upon soil pH and soil aeration. In the study there were significant changes in soil Fe, mean concentrations ranged between 4755 and 61 mg/kg with a sharp decrease in concentration in the last month (Fig. 3.25). The sharp decline in Fe on day 350 (August) coincides with a significant increase in soil pH (Fig. 3.20). There is no guideline for iron concentration in soils for South Africa. The decline in Fe may also be due to increased flooding. Compared to groundwater, Fe in soil was much higher. Iron concentrations in groundwater remained low throughout the year after its initial drop in October. The Fe concentration measured in the wetland is well above the average content of mineral elements in soil of 40 mg/kg (Larcher, 2003).

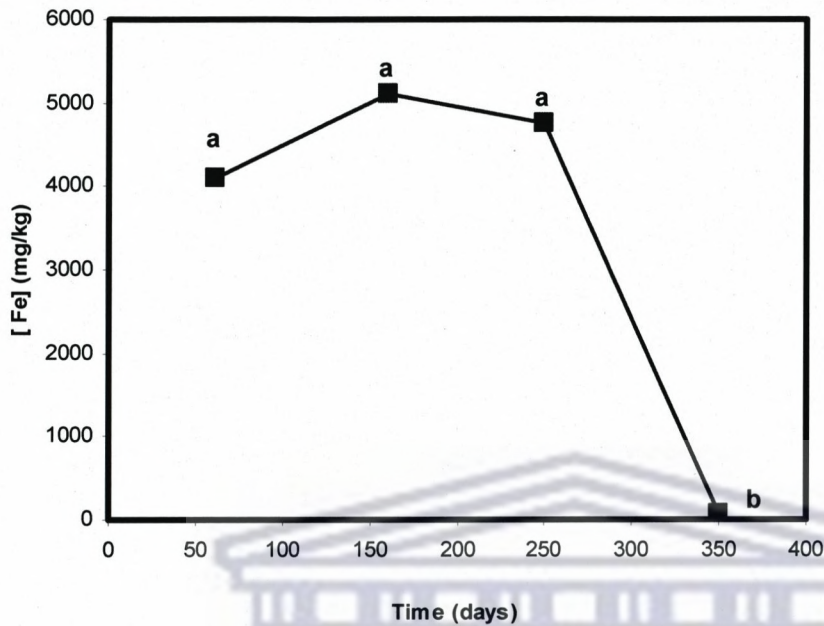

Figure 3.25 The variation in Fe in soil in the Franschhoek Trust Wetland in the 2008-2009 study period. Points marked with the same letter on the graph do not differ significantly ($p \leq 0.05$)

3.3.7 Nitrogen

Results show significant changes in N concentrations, with mean concentrations ranging between 1.43 and 2.42 mg/g (Fig. 3.26). Highest N levels were measured on day 160 (February). Low concentration in soil N corresponds with decrease in soil nitrate and nitrite (Fig. 3.28 and 3.29). The N concentration measured in the wetland soils is in line with the average content of mineral elements in soil of 2 mg/kg, plants require on average 15-25mg/kg of nitrogen to function optimally (Larcher, 2003).

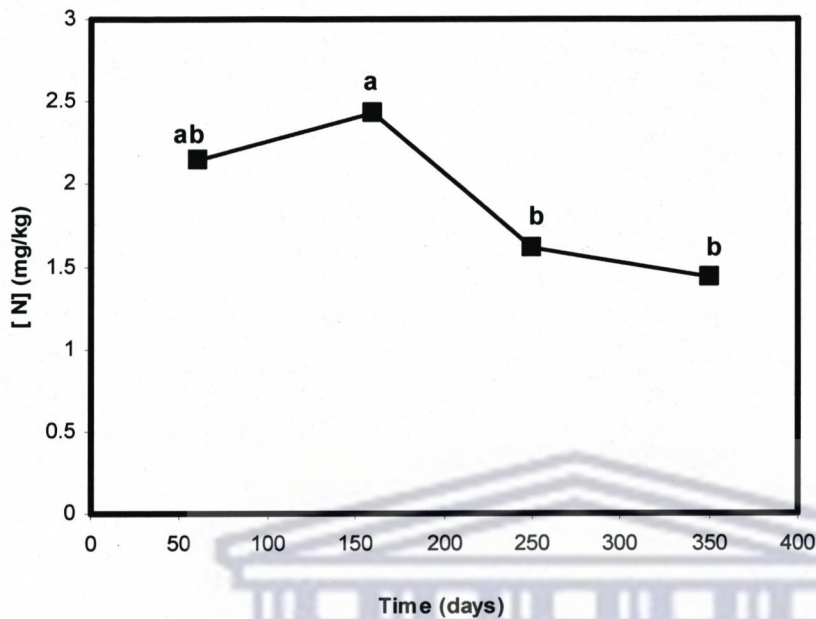

Figure 3.26 The variation in N in soil in the Franschhoek Trust Wetland in the 2008-2009 study period. Points marked with the same letter on the graph do not differ significantly ($p \leq 0.05$)

3.3.8 Ammonium

In the study period soil NH_4^+ varied between 0 and 6.1 mg/kg. During the study period there were significant changes in NH_4^+ concentration with mean levels dropping from 3.55 to 1.29 mg/kg (Fig. 3.27). The decrease in ammonium concentration in soil can be correlated to an increase in soil flooding and slower decomposition of organic matter. The highest levels of ammonium were measured in summer for groundwater, but with the onset of the rainy season concentrations dropped both in groundwater and soils.

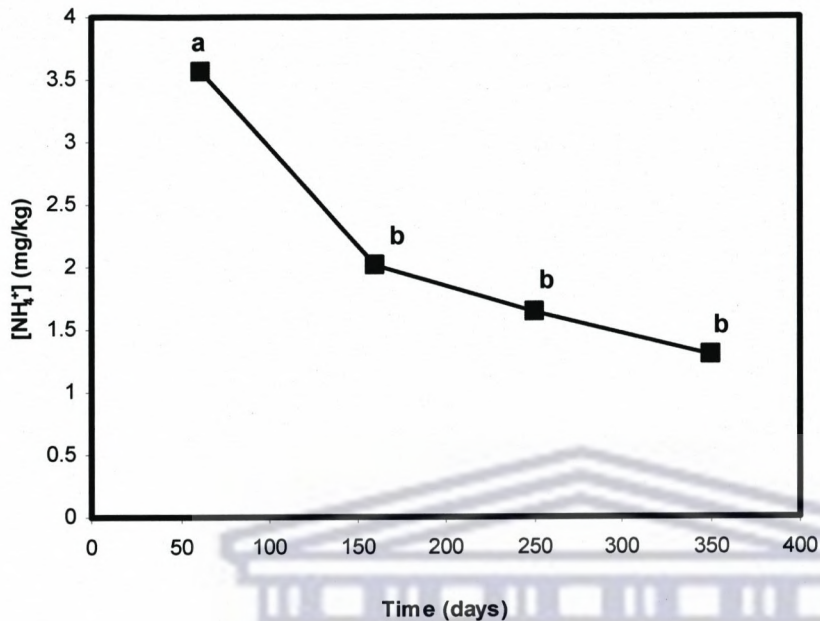

Figure 3.27 The variation in ammonium in soil in the Franschoek Trust Wetland in the 2008-2009 study period. Points marked with the same letter on the graph do not differ significantly ($p \leq 0.05$)

3.3.9 Nitrate

During the study period soil NO_3^- concentrations varied between 0 and 47 mg/kg. There were significant changes in NO_3^- concentrations mean concentrations ranged between 4.5 and 16.4 mg/kg (Fig. 3.28). Results showed a general increase in NO_3^- concentration with levels increasing significantly by day 250 (May) and 350 (August). Highest nitrate levels were measured in the summer months for groundwater, but were washed out with the onset of winter. In soils however nitrate levels increased with the onset of winter.

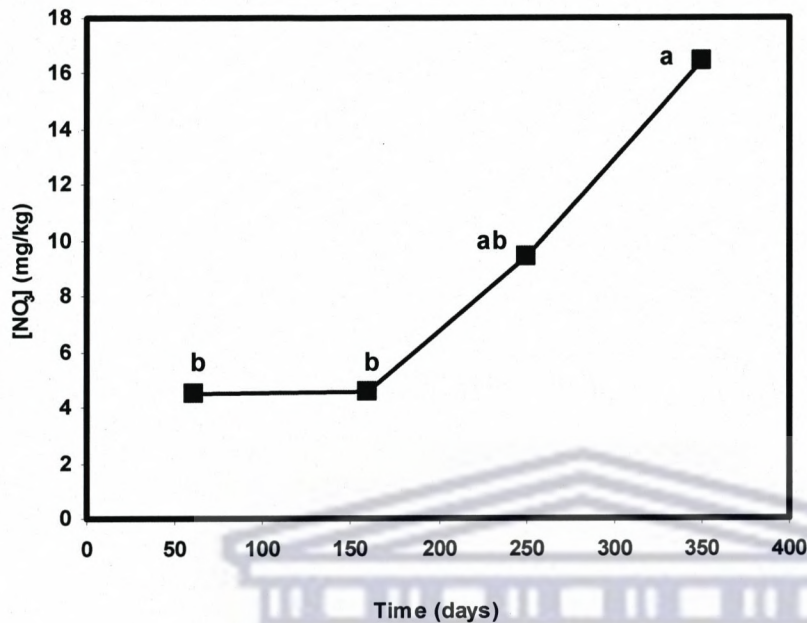

Figure 3.28 The variation in soil nitrate in the Franschhoek Trust Wetland in the 2008-2009 study period. Points marked with the same letter on the graph do not differ significantly ($p \leq 0.05$)

3.3.10 Nitrite

Nitrite in soil showed one significant change during the study period, concentrations remained low ranging between 0.3 and 2.6 mg/kg (Fig. 3.29). Soil NO₂⁻ levels gradually increased throughout the year, reaching its highest levels on day 350 (August). The significant increase on day 350 coincides with an increase in soil pH (Fig. 3. 20). For groundwater the highest nitrite levels were measured in summer, and then decreased in winter due to the flushing effect of winter rains. In soils the inverse was true and concentrations gradually increased with the onset of winter.

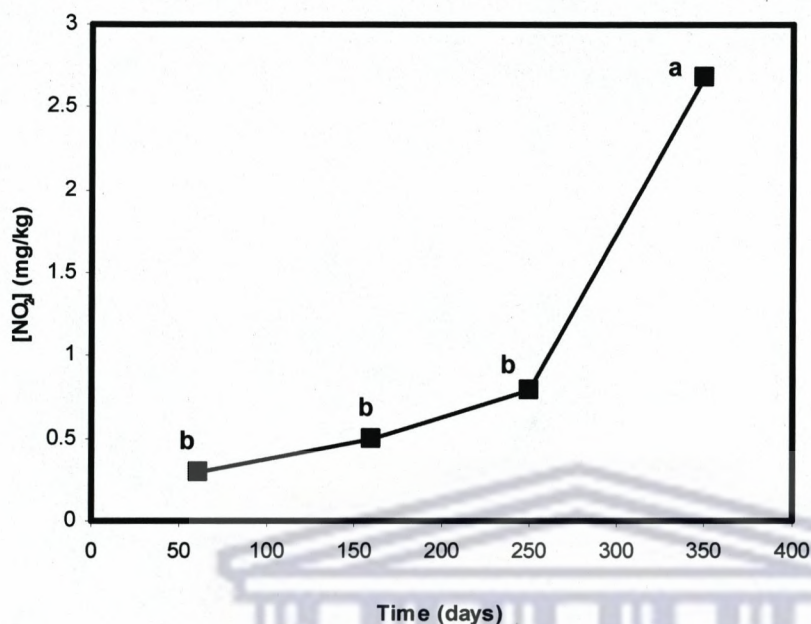

Figure 3.29 The variations in nitrite in soil in the Franschhoek Trust Wetland in the 2008-2009 study period. Points marked with the same letter on the graph do not differ significantly ($p \leq 0.05$)

3.3.11 Calcium and Phosphorus

During the period of investigation there were no significant changes in soil Ca and P concentrations (Table 3.6). For groundwater highest concentration were measured in November, which was the month in which lowest soil Ca concentrations were measured. The concentrations of P in groundwater and soils followed similar trends. In Larcher, 2003 the mean Ca concentration in soils is 15mg/l and plants require 3-15mg/kg to function optimally.

Table 3.6 The variation in concentration of Ca and P elements in soil in the Franschhoek Trust Wetland in the 2008-2009 study period. Points marked with the same letter do not differ significantly ($p \leq 0.05$)

Days passed	61	160	250	350
Soil Ca ²⁺ (mg/kg)	48.60a	77.29a	53.06a	54.41a
Soil P (mg/kg)	436.88a	475.51a	375.44a	364.26a

3.3.12 Soil seasonal trend summary

Soil pH increased with increased flooding. Electrical conductivity, iron, magnesium, total nitrogen, ammonia and phosphorus showed a similar seasonal trend with concentrations steadily decreasing with increased flooding in winter. Soil sodium, potassium nitrate and nitrite levels however increased flooding and highest levels were measured in the last month of sampling (August).

3.3.13 Relationship between groundwater and soil

Results show that although soil is the major source of nutrients to the wetland system, groundwater's contribution of nutrients play an important role as well. An inverse relationship was noted between soil and groundwater for Mg, Ca, Na, and nitrate and nitrite. This means that when nutrient concentrations drop in soil they are supplemented by that of groundwater. For some parameters such as pH, phosphorus and ammonium groundwater and soil followed similar trends. The similar trends observed for phosphorus and ammonia in groundwater and soil maybe due to these nutrients generally being released from the soil matrix, with very little contribution from groundwater (Dallas and Day, 2004; Palmer 2002)

3.3.13 Soil chemistry of the three hydrologic zones

Average soil mineral concentration of the three identified sites is compared in Table 3.7. Due to seasonal fluctuations and the effect of flooding and drying standard deviations are quite high in all three sites.

Mean EC was highest in the depression site this can be attributed to high calcium, magnesium, sodium and phosphorus concentration in the soil of this site for certain parts of the year. The submerged site had the highest average nitrate and nitrite and pH. Iron concentrations were high in all sites, but the high site had significantly higher iron concentration. According to Snowden and Wheeler (1995) high levels of iron are common in soils that are waterlogged. From the results it is clear that the mineral behaviour in soils that are continuously flooded (submerged site) compared to soils alternately dried and flooded (hollows) and its effect on the above water column is not the same. According to Mitsch and Gosselink (2007) when a soil is flooded redox potential and pH of the soil is altered which has an influence on the availability of major ions

such as potassium and magnesium. The state of reduction or oxidation of iron, nitrogen and phosphorus ions will determine their function in nutrient availability as well. Nutrient cycling and nutrient availability is thus significantly influenced by hydrologic condition. In soil that is alternatively dried and flooded, there are continual shifts in aerobic and anaerobic soil conditions. During periods of drawdown in summer greater microbial activity due to aerobic conditions stimulate the decomposition of organic matter which accumulated during anaerobic conditions, resulting in greater nutrient availability (McLatchey and Reddy, 1998; Wright, 2009). This has resulted in the hollow sites being much more nutrient rich.



UNIVERSITY *of the*
WESTERN CAPE

Table 3.7 The average soil mineral concentration of the three identified sites within in the Franschoek Trust Wetland for the study period 2009

Parameters	Hollows (n=20)		Submerged (n=20)		High sites (n=16)	
	Mean	Standard deviation	Mean	Standard Deviation	Mean	Standard deviation
EC	246.85	144.77	121.375	73.09	122.75	72.03
pH	5.28	2.63	5.32	2.62	5.20	2.56
Nitrate mg/kg	6.30	6.65	13.18	11.57	7.60	7.39
Nitrite mg/kg	0.55	0.89	1.88	1.91	0.93	1.25
NH4-mg/kg	2.75	1.78	1.17	1.01	2.26	1.43
Ca mg/kg	103.75	93.14	23.97	18.15	40.41	26.75
Mg mg/kg	41.69	28.98	27.72	22.54	22.71	18.92
Fe mg/kg	2239.25	1578.70	3290.21	3364.30	4950.91	5029.23
K mg/kg	1233.34	987.61	687.24	534.39	662.52	572.63
Na mg/kg	20.69	2.73	14.62	7.49	14.21	7.88
N mg/kg	3.09	2.07	0.75	0.40	1.63	0.89
P mg/kg	527.97	358.7	301.62	151.56	387.18	214.48

3.4 Vegetation

As is common for palustrine wetlands in South Africa (Kotze *et al*1994) the study wetland displayed three distinct zones with varying degrees of wetness ranging from temporary with predominantly grass species, seasonal with predominantly sedges and grasses and permanent /semi- permanent with predominantly reeds, sedges and/or bulrushes (See Fig. 3.30). According to Van der Valk (2006) this is due to vegetation at different elevations experiencing different water regime, so that vegetation in the deepest part of the wetland may be permanently flooded, whilst at increasingly higher elevations are semi- permanently, seasonally, temporarily and intermittently flooded.



UNIVERSITY *of the*
WESTERN CAPE

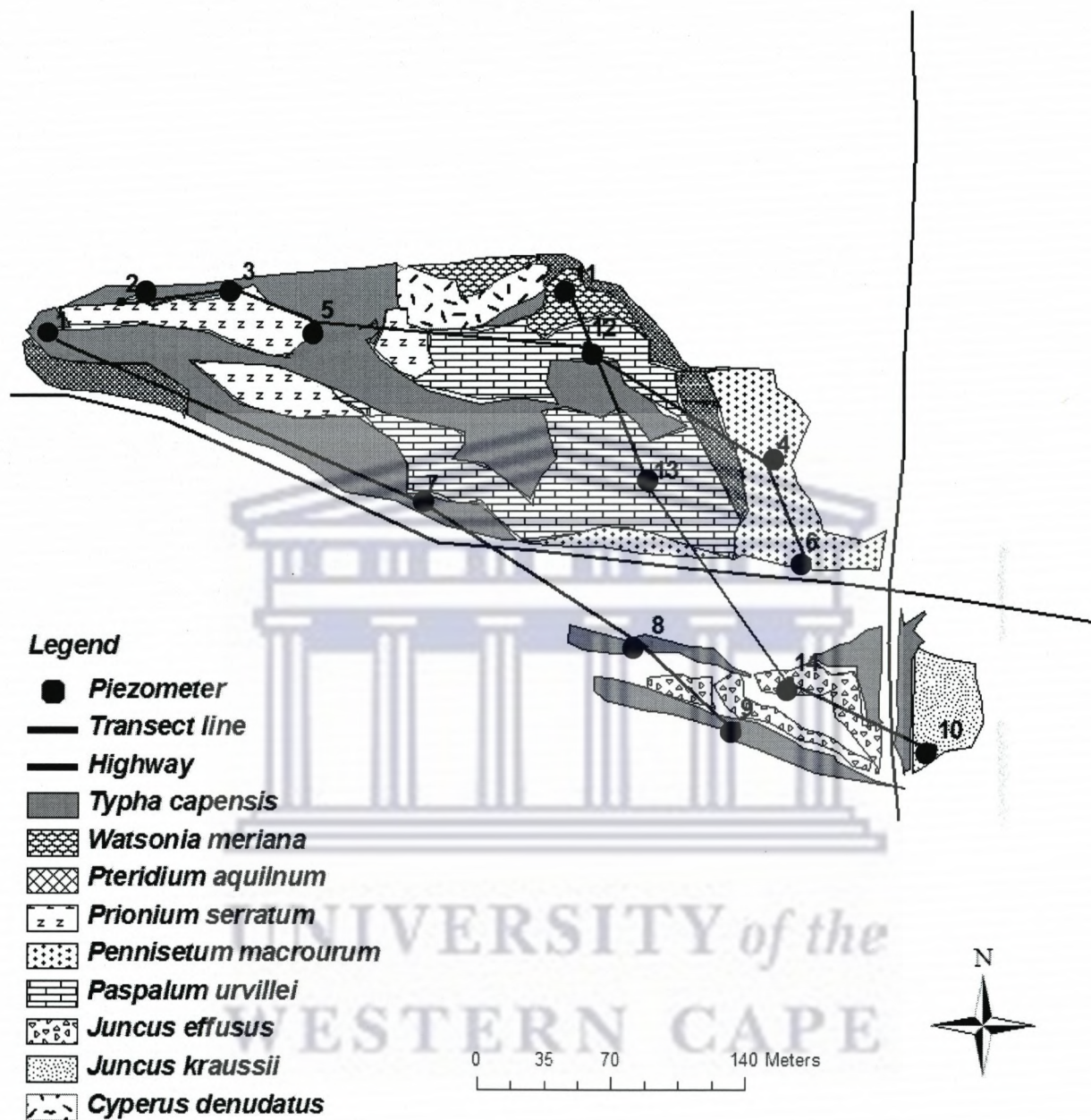

Figure 3.30 The distribution of major vegetation zones and piezometer placement in the Franschhoek Trust Wetland in the 2008-2009 study period.

3.4.1 Description and distribution of major vegetation zones

In the study wetland vegetation zones remained the same and no species were replaced during the period of investigation. This can be explained by the low mean water level fluctuation observed (Table 3.3).

Prionium serratum occupied the deepest part of the wetland where standing water levels of 30-42 cm were measured (Fig. 3.30). *Prionium serratum* also known as Palmiet is a robust tufted evergreen with sharply serrated leaves; its flowers are a branched inflorescence flowering from September to February (Cook, 1974). *Prionium* has a thick main stem (50-100mm in diameter) and grows up to 2 meters. According to Job and von Witt (2008) *Prionium serratum* is semi aquatic and is mainly found along lower reaches of rivers in the Southern and South-western Cape.

Typha capensis enjoyed the widest distribution in the wetland and was found in standing water levels of 7 to 30cm (Fig.3.30) *Typha capensis* or Papkuil, is a tufted, rhizomatous perennial growing up to 2m in height, with broad leaves and a distinctive velvety-brown flower spike (Cook, 1974). According to Job and von Witt (2008) its wide distribution can be attributed to its ability to survive both extremes of wet and drought, thus out-competing many other species. *Typha* can also colonize areas rapidly due to its creeping rhizomes (Cook, 1974). Mixed in between the *Typha* were *Zantedeschia othiopica* (arum) and *Thelypteris palustris*.

Paspalum urvillei is of the Poaceae family and was found at standing water levels of 4 to 5 cm (Fig. 3.30). *Paspalum urvillei* also known as Giant paspalum is an erect tufted perennial grass with flowering stems up to 250 cm high, and long leaves (Tainton *et al* 1976). Flowers appears in October to May (Trinder-Smith, 2003). The plant is a native of South America but has been naturalized here in South Africa, where it occurs in wet soils and seasonal wetland along river banks and along road verges (Tainton *et al* 1979).

Watsonia meriana was found growing only on the slopes of the wetland in standing water levels of 1-2 cm (Fig. 3.30). *Watsonia meriana* which forms part of the Iris family is an erect perennial herb which grows in clumps, with strap like leaves, slender reddish flowering stems (0.5 to 2m high) with pink orange or reddish flowers and underground corms (Spooner *et al* 2008). According to Goldblatt (1989), *Watsonia meriana* is widespread in the Cape winter rainfall area and usually occurs in a seasonally moist situation in sand or thin rocky soil.

Pennisetum macrourum was most abundant on the western side of the wetland and occurred in standing water of 5-11cm (Fig. 3.30) *Pennisetum macrourum* or African feather grass is a 1-1.8m perennial tussock- forming rhizomatous grass, with long thin bristly inflorescence which flowers in spring to summer (Global Invasive Species Database, 2008). The grass which is native to South Africa spreads aggressively by rhizomes to form large masses (Darke, 1999). Leaves are green to grey green with flowers are green and turn light tan upon drying. The grass is adapted to growth in a wide range of soil and moisture conditions and is often found growing in wetland areas (Darke, 1999)

Juncus kraussii dominated the western side of the smaller wetland and was found growing in standing water of 4 to 15cm (Fig. 3.30). *Juncus kraussii* or dune slack rush, is a rigid tufted perennial growing up to 1.5m high, with long narrow leaves which are tightly pressed against the stem Job and von Witt (2008). It usually grows in large colonies and has a brown inflorescence which flowers between October and February (Goge, 2006).

Juncus effusus was most prevalent on the eastern part of the smaller wetland and occurred in standing water of 5-15 cm (Fig.3.30). *Juncus effusus* also known as soft rush is a perennial growing in tufts or tussocks, with bright green stems. The leaves are reduced and its flowers and fruits grow in compact clusters. According to Trinder-Smith (2003) the rush grows vigorously in heavy wet soils, but can withstand periods of drying out.

Cyperus denudatus was most abundant in the northern side of the bigger wetland and was found in standing water of 1 to 8cm (Fig. 13.30). *Cyperus denudatus* is a perennial emergent herb which can grow up to 0.9 m (Southern Africa on-line checklist, 2005). Stems are triangular with leaves reduced to sheaths (Cook, 1974). Its inflorescence consists of one to many heads bearing cluster of spikelets that flower in summer (Trinder-Smith, 2003). The plant is common in wet or regularly inundated regions.

Pteridium aquilinum was found on the edges of the wetland in standing water levels of 1 to 5cm (Fig. 13.30). *Pteridium aquilinum* can be found in a variety of habitats which include lowland, medium altitude, montane and high montane areas, it is widespread in Africa and is almost cosmopolitan (Vollesen, 1998). In South Africa they tend to dominate in high laying areas of disturbed moist grassland areas (Grenfell *et al* 2005).

3.4.2 Biomass

In Fig. 3.31 the biomass of the plant species in the three identified zones in the wetland are compared. Each one of the plots had one dominant species. *Typha capensis* in the depression sites has its most active growth in summer and goes dormant each winter, when aboveground parts die off. *Paspalum urvillei* in the high sites is a perennial graminoid which flowers and sets seed each spring or summer, and goes dormant each winter. And *Juncus kraussi* in the no outlet site which has a high standing crop of live culms present throughout the year and dead material which generally exceeds this. All three sites had its highest standing biomass in April, although classified as an autumn month in South Africa, is still relatively warm with limited rainfall (See Table 3.1). From the graph (Fig. 3.31) *Juncus kraussii* had the highest average biomass production for most of the months in which biomass was recorded. The high biomass production of *Juncus kraussii* can be attributed to its ability to produce new culms throughout the year (Congdon and McComb, 1980. b). This means that it requires more available nutrients for consumption than the other two species which are dormant during winter.

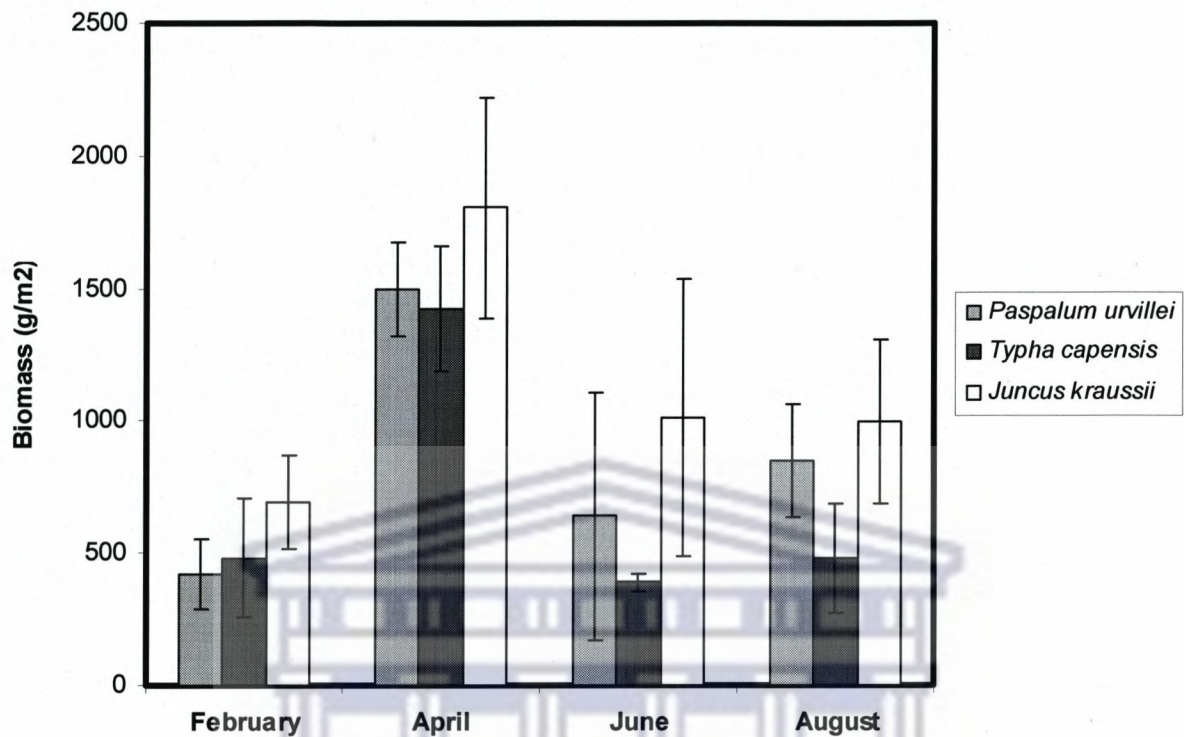

Figure 3.31 Means and standard deviation of biomass in grams per square meter of the three most dominant species in the high, hollows and submerged zones respectively (n=3).

3.4.3 Nitrogen and Phosphorus concentration

According to Verhoeven *et al* (1996) nutrient limitation affects species composition of plant communities through selecting species that are best adapted to shortage of a particular nutrient. Nitrogen and phosphorus concentration of the aboveground biomass of the three most dominant species in the wetland was compared (Fig. 3.32 and 3.33). When putting statements on the nutrient limitation using 12 mg N/g dry weight and 0.7 mg P/g dry weight as the tilting point to respective N-and P-limitation, the nitrogen concentrations indicate N-limitation in all sites. According to Reddy and DeLaune (2008) wetlands is very rarely phosphorus limited. In nitrogen deficient environments such as this, nitrogen fixation is one mechanism by which plants can meet a portion of their nitrogen needs. Research done by Maasdorf (1987) showed that *Paspalum urvillei* growing in seasonally waterlogged areas in Zimbabwe fixed 76 kg N ha⁻¹ by nitrogen fixation. *Juncus kraussii* is also known to make use of nitrogen fixation to acquire

nitrogen (Congdon and McComb, 1980.a). The site in which *Juncus kraussii* was most dominant had less N limitation than the sites of the other two species (Fig 3.32). This site showed higher nitrate concentration in its groundwater and soil (Table 3.6 and 3.7) which could be attributed to nitrate inputs from agricultural runoff (Table. 3.4). In August the zone dominated by *Typha Capensis* had the highest nitrogen concentration (Fig. 3.32). This increase in nitrogen in above ground parts of *Typha capensis* coincides with an increase in soil nitrate levels (Fig. 3.28). It was mentioned earlier that during the winter months the above ground parts of *Typha capensis* die off and the rhizomes are dormant. It is well known that emergent macrophytes release nutrients back into the environment upon senescence and decomposition (Kröger *et al*2007). The effect may be more pronounced in *Typha capensis* due to *Juncus kraussii*'s culms not falling off immediately when they die, the thick cuticle around the culms of the rush may also inhibit leaching of nutrients. Phosphorus concentration in the above ground biomass was high in all three sites (Fig. 3.33). According to Reddy *et al*(1996) phosphorus availability is higher in soils that have slightly acidic to neutral pH (Fig. 3.20) this could explain the high available phosphorus in the wetland. The amount and ability of phosphorus uptake is different for every plant species (Friesen *et al* 1997). It varies by season, latitude and species attributes such as growth rate and maximum biomass (Cronk and Siobhan Fennessy, 2001). Phosphorus concentrations were highest in February for all three species. This increase in concentration is in line with a study done by (Richardson and Marshall, 1986) where highest phosphorus removal or uptake was measured in the growing season. During the period of study *Paspalum urvillei* had the highest phosphorus content throughout the year, except in August (Fig. 3.33). These results match the research done by Beadle *et al* (2004) which show that when exposed to higher levels of nutrients, *Paspalum urvillie* will respond by increasing the concentration of nutrients in their tissue in what is referred to as luxury consumption. *Typha capensis* had lower phosphorus concentration and less pronounced seasonal fluctuations than the two other species (Fig.3.33), this could be due to its ability to store large amounts of nutrients in belowground tissue, which is utilized for growth under low nutrient conditions. From Fig. 3.32 and 3.33 it is clear that *Juncus kraussii* has a very good ability to trap nutrients which allows it to form the dense colonies seen in the wetland.

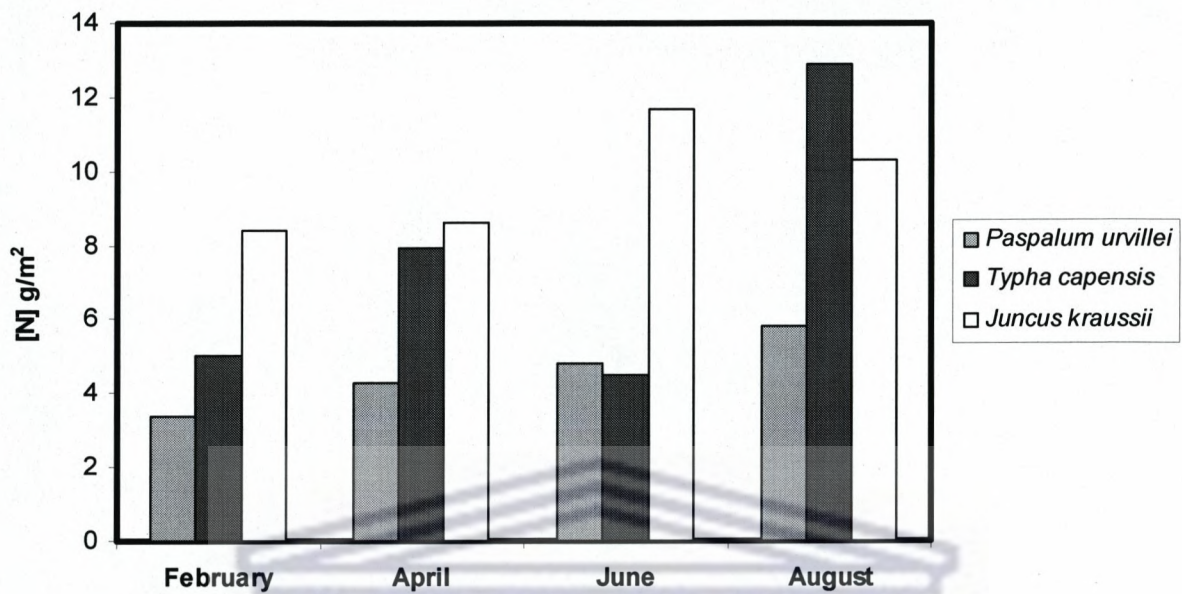

Figure 3.32 Nitrogen concentrations in above ground biomass of the dominant vegetation type in each hydrologic zone.

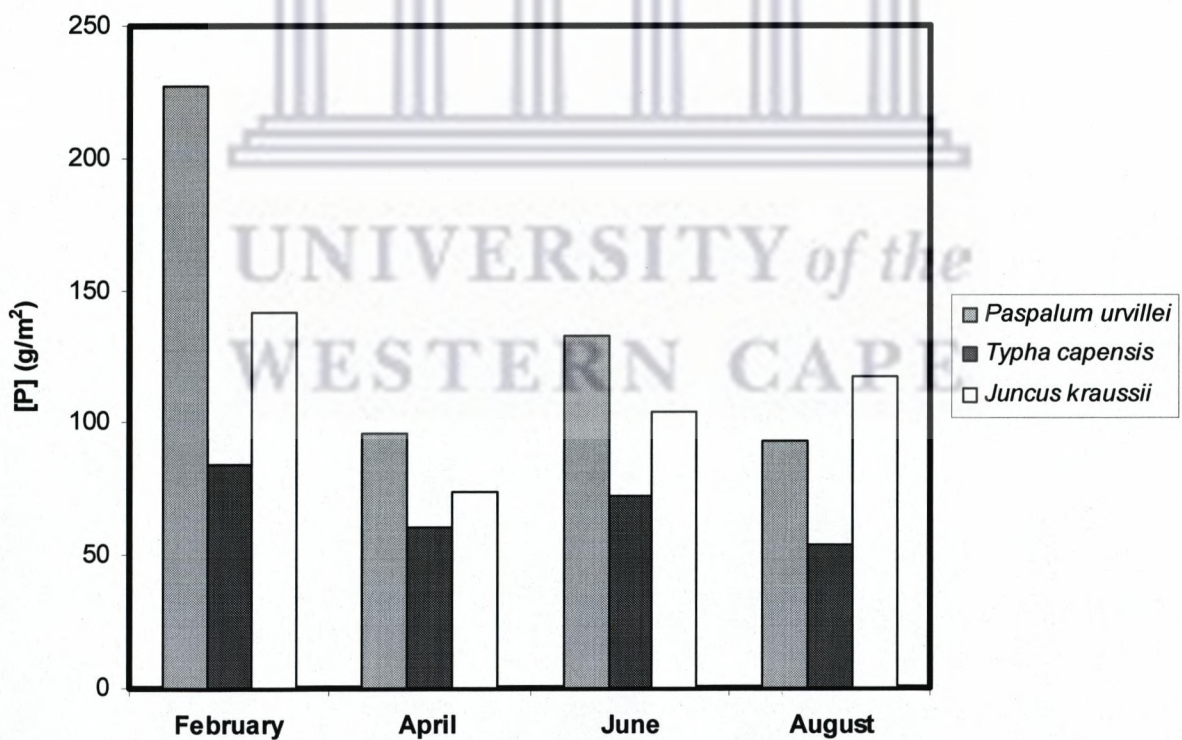
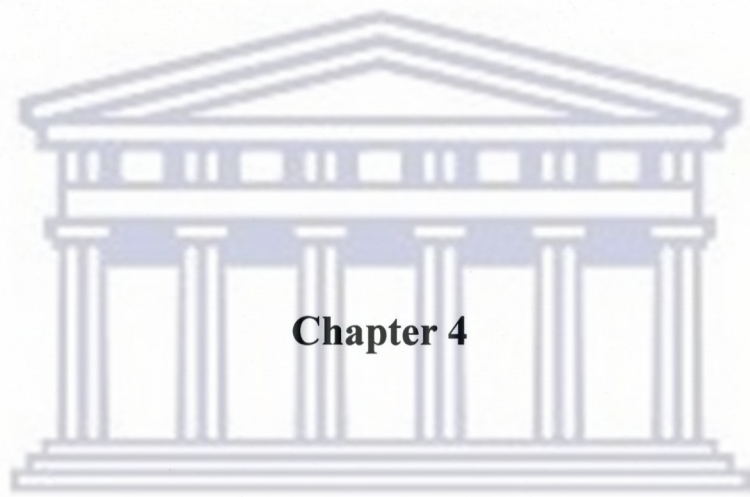

Figure 3.33 Phosphorus concentrations in aboveground biomass of the dominant vegetation in each hydrologic zone.



Chapter 4

UNIVERSITY *of the*
Summary and recommendations
WESTERN CAPE

4.1 Summary

The ecohydrological investigation of abiotic factors groundwater, soil and nutrient availability and its relationship with biotic factors of vegetation was undertaken to monitor and provide recommendations on how to conserve and manage the Franschoek Trust Wetlands more effectively. The approach that has been taken in this research was to enhance the understanding of the development, structure and dynamics of this particular wetland ecosystem in order to provide a platform from which more effective management actions can be undertaken. Three environmental drivers have been identified within the wetland system and can be used to facilitate the detection of change detrimental to the health of the wetland.

4.1.1 Hydrology

Small fluctuation in water levels points toward groundwater being a key source of water supply to the wetland. Of the parameters measured in groundwater similar trends were observed for bicarbonate, potassium, calcium, phosphorus, nitrate, nitrite and ammonium (Section 3.2). For all of these parameters maximum concentrations were reached in the warm dry summer months, which then attenuated with the onset of the rainy season in winter. Surface water inputs to the wetland are from agricultural and road runoff as well as from a river. These inputs contribute significantly toward nitrate, chloride and bicarbonate in the system, but are not negatively effecting the functioning of the wetland (Section 3.2.15). A PCA done on water parameters show that sodium, chloride, bicarbonate, phosphorus and ammonium play a dominant role in the overall chemistry of the groundwater (Section 3.2.17.1). During the low rainfall summer months surface inlet sources dry up completely, this in addition with high evaporation rates lead to a natural increase in salts associated with increased saline conditions. The drop in water levels in summer, allow for increased decomposition of organic material which release ammonium and phosphorus amongst other nutrients. Similarities in the chemistry of the surface water outlet and deeper groundwater points toward surface water groundwater interaction (Section 3.2.17.1). Comparison of the surface water inlets with the surface water outlet showed a general increase in water quality for the outlet (Section 3.2.15).

4.1.2 Topography

The interaction between topography and hydrology is one of the main environmental factors structuring vegetation distribution in the wetland. Although groundwater fluctuation was negligible, differences in flooding frequency and duration due to microtopographical differences led to the establishment of sites which were different in their soil aeration, soil chemistry and biogeochemical cycling. Three hydrologically distinct sites were identified with the help of a Principal Component Analysis done on elevation, maximum and minimum groundwater levels (Section 3.1.17.2). Hollows or low sites were dominated by species such as *Typha capensis* and *Prionium serratum* with standing water levels of 5-40 cm (Section 3.2.1). These sites are significantly more nutrient rich than the two other sites with high calcium, magnesium, potassium, sodium, total nitrogen and phosphorus concentration in soil. Intermittent flooding and drying conditions experienced in these sites means that during winter anaerobic conditions in the soil slows down decomposition rates causing a build up of organic matter. In summer when water levels drop, aerobic conditions allow for increased decomposition rates of the accumulated organic matter and higher nutrient releases. High sites situated at slightly higher elevations are rarely or never flooded and are characterized by the perennial geophyte *Watsonia mariana* and wetland grasses such as *Paspalum urvillei* and *Pennisetum macrourum* with standing water levels of 0 to 10 cm (Section 3.2.1). Contact with mostly shallow groundwater distinguishes this site from the other two, and is characterized by higher groundwater temperatures, ammonium in water and iron in soil and groundwater (Table 3.5 and 3.7). The third site is hydrologically different due to human influence in the form of road construction. This part of the wetland (labeled as parts B and C) is dominated by the rushes *Juncus kraussi* and *Juncus effusus* with standing water levels of 5-15cm. Slower outflow of groundwater in these sites have led to higher standing water levels EC, bicarbonate and sulphate (Table 3.5). The results highlight the importance of small scale gradients such as microtopography within the wetland system.

4.1.3 Nutrient availability

Another important factor structuring vegetation distribution is nutrient availability. The wetland is nitrogen limited, this means that the most successful species in the wetland are those able to adapt to the shortage of nitrogen in the system. The three most dominant species in the wetland

Typha .capensis, *Paspalum urvillei* and *Juncus kraussi* are able to either fix nitrogen or store nitrogen during more favorable conditions.

Soil is the major contributor of nutrients to the wetland. Results show pH, sodium potassium, nitrate and nitrite levels increase with increased soil flooding whereas iron, calcium, magnesium total nitrogen, ammonium and phosphorus decrease with increased soil flooding (Section 3.2). Changes in the current hydrologic regime will therefore affect the availability and toxicity of these nutrients. Some parallels were found between groundwater and soil with phosphorus, ammonium and pH following similar trends. Inverse relationship was more prominent though with groundwater concentration of Mg, Ca, Na, and NO_3^- and NO_2^- increasing with decreasing soil concentrations and vice versa.

4.2 Conclusion

An understanding of how a specific site formed geologically and hydrologically and how physical and chemical processes function under natural conditions is critical for the effective management of all services provided by the wetland as an ecosystem. With the background information obtained in this study the role of human stressors and disturbances can be evaluated and quantified, and the influence of urban and agricultural activities can be quantified. From the study it is clear that the wetland influences the flow of water, sediments and nutrients over the landscape and thus has implications for water storage, stream flow regulation, flood attenuation, soil erosion and water purification. In terms of human interference, the construction of the road has altered the hydroperiod of the wetland site identified as site B. The construction of the road has resulted in constricted water flow between the wetland sites, decreasing flow so that water dams up creating a permanent lake in site B. The increase in the standing water level of site B means that there is an increased probability of adsorption, biological processing and retention of nutrients in this part of the wetland (Section 3.1.18 and 3.2.13). The change in hydroperiod may also have altered the wetland's ability to provide water quality and quantity support to benefit water supply further downstream. Current loading rates of incoming water do not exceed the wetland's ability to assimilate nutrients and are not a major concern. Based on the major drivers

of the wetland system the main threats to the conservation of the wetland are; groundwater abstraction, water pollution, intensification of agriculture and other land use in the area.

The wetland can be classified as a palustrine valley bottom with channel wetland, with groundwater as the main long term source of water it is therefore phreatotrophic. The strong groundwater dependence of the wetland makes it sensitive to hydrological disturbance caused by unsustainable groundwater use. Increase water demand has led to investigations into the use of the groundwater of the Table Mountain aquifer to supplement demand. It is highly probable that the Franschhoek Trust Wetland is fed by this aquifer as is many wetlands and rivers in the Western Cape (Roets et.al. 2008). Intensified groundwater abstraction would directly affect the hydrologic regime of the wetland. In the wetland the main chemical concentration changes takes place in summer and winter. Concentrations for most of the parameters reach their peak in summer as a result of increased soil aeration and release of nutrients from organic matter. Lowest levels are reached in winter when increased rainfall washes out most of the nutrients. Lowering of the groundwater table may result in a longer and drier summer conditions, leading to increased nutrient availability. The dominant role of sodium, chloride and bicarbonate in the system may lead to increased salinity of the wetland as it already experiences natural increases in salinity during summer. Increased salinity will negatively influence the biota of the wetland and may lead to wetland degradation. Changes in water quantity are likely to have an influence on water quality as well which will in turn affect biota. *Typha capensis* is known as an aggressive species and currently occupies the low lying and naturally nutrient rich areas of the wetland. An increase in groundwater abstraction can have a direct effect on the wetland at a local scale in terms of its nutrient cycling and hydrologic regime. In addition polluted surface water inputs and intensified agriculture and urbanization could further influence the nutrient load of the wetland. The alteration of the nutrient cycling and water regime would favour the dominance of species such as *Typha capensis* at the expense of a diverse community. The largely nitrogen-limited nature of the wetland makes it vulnerable to ecosystem change due to increased nitrogen loads. According to Downing (1999) much of the increases in nitrogen loads results from human inputs of urban and agricultural waste (including sewage and fertilizers) and increased runoff due to cultivation and urbanization. The consequence of increased nitrogen availability in a site which previously had limited concentrations of nitrogen is a change in the composition of the present species to one which is better adapted to nitrogen availability. This will alter ecosystem functions

such as primary productivity and nutrient cycling (Elser *et al*1988; Shaver *et al*2001). Expansion in agricultural and urban activities can also result in increased sediment deposition from runoff entering the wetland. Werner and Zedler (2002) show that sediment accumulation has an effect on soil properties, microtopography and vegetation.

4.3 Recommendations

1. It is recommended that closer partnerships be forged between wetland scientists and wetland managers. This is a background study on the functioning of the wetland and will need to be linked with management strategies to ensure the sustainability of the wetland and the services it provides.
2. Monitoring to understand the long term dynamics of the ecosystem is essential. A monitoring network has already been set up for the purpose of this research and continued and long term research, in order to evaluate and model future trends is highly recommended.
3. Accessing the wetland to take depth to water measurements is time consuming and tedious, installation of divers in the piezometers that can record groundwater levels will be very useful in the detection of changes in groundwater.
4. The wetland is situated quite close to an urban settlement and primary school; awareness can be raised regarding the importance and role of the wetland in the catchment. A volunteer monitoring programme should also be encouraged

4.4 References

- Azous, A.L., Horner, R.R. 2001. *Wetlands and Urbanization: implications for the future*. CRC Press, London U.K.
- Baird, A.J., Wilby R.L. 1999. *Eco-hydrology: plants and Water in Terrestrial and Aquatic Environments*. Routledge, London, U.K.
- Beadle, J.V., Holland, M.M., Moore, M.T., Cooper, C.M. 2004. *Nutrient uptake by two common freshwater wetland plants (abstract)* .International Wetlands Conference Intercol, pp. 26
- Benayas,R., Jose, M., Scheiner, S.M 1993. Diversity patterns of wet meadows along geochemical gradients in Central Spain. *Journal of Vegetation Science* 4:103-108
- Bledsoe, B.P., Shear, T.H. 2000. Vegetation along hydrologic and edaphic gradients in a North Carolina coastal plain creek bottom and implications for restoration. *Wetlands* 20:1 126-147
- Blom, C.W.P.M., Voesenek, L.A.C.J. 1996. Flooding: the survival strategies of plants. *TREE* 11:7 290-295
- Brinson, M.M. 1993. *A Hydrogeomorphic Classification for Wetlands, Wetland Research Program Technical Report*, US Army Corps of Engineers, Waterways Experiment Station Technical Report WRP-De-4
- British Columbia Ground Water Association (2007) Ground Water Development, [http://www.env.gov.bc.ca/wsd/plan_protect_sustain/groundwater/library/ground_fact_sheets/pdf/na\(020715\)_fin2.pdf](http://www.env.gov.bc.ca/wsd/plan_protect_sustain/groundwater/library/ground_fact_sheets/pdf/na(020715)_fin2.pdf) on 21 January 2010
- Brooks, R. 1998. *Plants that hyperaccumulate heavy metal: Their role in phytoremediation, microbiology, archaeology, mineral exploration and phytomining*. CAB International, New York
- Bruland, G.L., Richardson, C.J. 2005. Hydrologic, edaphic and vegetative responses to microtopographic reestablishment in a restored wetland. *Restoration Ecology* 13:3 515-523
- Bullock, A., Acreman, M.C. 2003. The role of wetlands in the hydrological cycle. *Hydrology and Earth Systems Sciences* 7:3 358-389
- Casanova, M.T., Brock, M.A. 2000. How do depth, duration and frequency of flooding influence the establishment of wetland plant communities? *Plant Ecology* 147:237-250
- Cirno, C.P., Driscoll, C.T. 1993. Beaver Pond Biogeochemistry: acid neutralizing capacity generation in a Headwater Wetland. *Wetlands* 13:4 277-292
- Coetzee M.A.S 1995. *Water pollution in South Africa its impact on wetland biota*. In *GI Cowan wetlands of South Africa*, Department of Environmental Affairs and Tourism, pp 247-262

- Congdon, R.A., McComb, A.J. 1980.a. Nutrient pools of an estuarine ecosystem: the Blackwood River Estuary in south-western Australia. *Journal of Ecology* 68:1 287-313
- Congdon, R.A., McComb, A.J. 1980 b. Productivity and nutrient content of *Juncus Kraussii* in an estuarine marsh in South-Western Australia. *Austral Ecology* 5:2 221-234
- Cook, C.D.K. 1974. *Water Plants of the World: a manual for the identification of the genera of freshwater macrophytes*. Dr. W.Junk b.b. Publishers, The Hague, Netherlands.
- Cowardin, L.M., Carter, V., Golet, F.C., Laroe, E.T. 1979. *Classification of wetlands and deepwater habitats of the United States*. U.S Department of the Interior Fish and Wildlife Service, Washington D.C,
- Cronk, J.K., Siobhan Fennessy, M. 2001. *Wetland plants: biology and ecology*. CRC Press, London, U.K.
- Dallas, H.F., Day, J.A. 2004. *The effect of water quality variables on aquatic ecosystems: a review*, Water Research Commission (WRC) Report number TT224/04, S.A.
- Dallas, H., Seymour C., Snaddon K., Ewart-Smith J. 2006. *Identification and collation of existing information of the wetlands of the Western Cape*, The Freshwater Consulting Group/Freshwater Research unit, University of Cape Town, Project ZA5095
- Darke, R. 1999. *The color encyclopedia of ornamental grasses: sedges, rushes, restios, cat-tails and selected bamboos*. Timber Press, California, USA
- Darrin Fresh Water Institute 2009. Research Centre of Rensselaer Polytechnic Institute, http://www.rpi.edu/dept/DWFI/dfwiwq/water_quality_parametes.html on 20 January 2010
- Deegan, B.M., White, S.D., Ganf, G.G. 2007. The influence of water level fluctuations on the growth of four emergent macrophyte species, *Aquatic Botany* 86:309-315
- DeKeyser, E.S., Kirby, D.R., Ell, M.J. 2003. An index of plant community integrity: development of the methodology for assessing prairie wetland plant communities. *Ecological Indicators* 3: 119-133
- Department of Water Affairs and Forestry. 1996a. South African water quality guidelines 2nd Ed. Volume 4: Agricultural use: Irrigation, DWAF, Pretoria, S.A.
- Department of Water Affairs and Forestry. 1996b. *South African water quality guideline 2nd Ed. Volume 7: Aquatic Ecosystems*, DWAF, Pretoria, S.A.
- Domenico, P.A., Schwarz F.W. 1998. *Physical and Chemical Hydrogeology*. 2nd Ed. Wiley and Sons, New York. U.S.A.
- Downing, J.A., McClain, M., Twilley, R., Melack, J.M. Elser, J. Rebalias, N.N., Lewis W.M. Jr., Turner, R.E., Corredor, J., Soto, D., Yanez –Arancibia, A., Kopaska J.A., Howarth R.W. 1999. The impact of accelerated land use change on the N-cycle of tropical aquatic ecosystems: Current conditions and predicted changes. *Biogeochemistry* 46:1/3: New perspectives on nitrogen recycling in the temperate and tropical Americas, 109-148

Dugan P.J. (ed) 1990. *Wetland conservation: a review of current issues and required action*, The World Conservation Union, Switzerland

Ehrenfeld, J.G. 1983. The Effects of Land-Use Changes on Swamps of the New Jersey Pine Barrens. *Conservation Biology* 25: 353-375

Ehrenfeld, J.G., Schneider, J. P. 1991. *Chamaecyparis thyoides* wetlands and suburbanization: effects of nonpoint source water pollution on hydrology and plant community structure. *Journal of Applied Ecology* 28: 467-490

Ellery, F. 2005. Wetland origin and evolution, Wetland Research Group, University of KwaZulu-Natal <http://www.geography.ukzn.ac.za/wetlands/okavango.htm> on 21 October 2009

Elser, J.J., Elser, M.M., MacKay, N.A., Carpenter, S.R. 1988. Zooplankton mediated transition between N and P –Limited Algal growth. *Limnology and Oceanography* 33:1 1-14

Euliss, N.H., Mushet, D.M. 1996. Water level fluctuations in wetland as a function of landscape condition in the Prairie Pothole Region. *Wetland* 4:587-593

Euliss, N.H., Smith, L.M., Wilcox, D.A., Browne, B.A. 2008. Lining ecosystem processes with wetland management goals: Charting a course for sustainable future, *Wetlands* 28:3 553-562

Ewart-Smith, J., Ollis, D., Day, J., Malan, H. 2006. *National wetland inventory: development of a wetland classification system for South Africa*. Final Report, Water Research Commission (WRC) and South African National Biodiversity Institute (SANBI)

Falconer, R.A., Goodwin P. (ed) 1994. *Wetland management: proceedings of the international conference organized by the Institution of Civil Engineers and held in London on 2-3 June 1994*, Institution of Civil Engineers, London

Federal Interagency Committee for Wetland Delineation 1989. *Federal manual for identifying and delineating wetlands*. US Army Corps of Engineers, US Environmental Protection Agency, US Fish and Wildlife Service and USDA Soil Conservation Service, Washington D.C. *Cooperative technical publication*, pp. 79

Freeman, N.M., Rowntree, K. 2005. *An introduction to the science and practice of fluvial geomorphology*, Water Research Commission (WRC) TT238/05, S.A.

Friesen, D.K., Rao, I.M., Thomas, R.J., Oborson, A., Sanz, J.I. 1997. Phosphorus acquisition and cycling in crop and pasture in low fertility tropical soils. *Plant and Soil* 196:289 -294

Gladstone Bell, F. 1998. *Environmental geology: principles and practice*. Wiley-Blackwell, London, U.K.

Global Invasive Species Database 2008. IUCN/SSC Invasive Species Specialist Group (ISSG) with support from ASB Community Trust, New Zealand
<http://www.issg.org/database/species/ecology.asp?si=1353&fr=1&sts=&lang=EN>

Goge M. 2006. *Juncus kraussii*, Working for water, South African National Biodiversity Institute (SANBI) URL <http://www.plantzafrika.com/planthij/juncuskraus.htm>

- Goldblatt, P. 1989. *The genus Watsonia: a systematic monograph*. National Botanic Gardens, Cape Town, S.A.
- González Bernáldez, F. 1992. Ecological aspects of wetland/groundwater relationships in Spain. *Limnetica* 8:11-26
- Görgens, A.H.M., de Clercq, W.P. (editors) 2006. *Research on berg river water management: summary of water quality information systems and soil quality*. Water Research Commission Report (WRC): TT 25206, S.A.
- Grenfell, M.C., Ellery, W.N., Preston-Whyte, R.A. 2005. Wetlands as early warning (eco) systems for water resource management, *Water SA* 31:4 465-472
- Grieve, I.C., Gilvear, D.G., Bryant, R.G. 1995. Hydrochemical and water source variation across a floodplain mire, Insh Marshes, Scotland. *Hydrological Processes* 9:1 99-110
- Griffioen, J. 2001. Potassium adsorption ratios as an indicator for the fate of agricultural potassium in groundwater. *Journal of Hydrology* 254:244-154
- Güsewell, S., Bollens, U. 2003. Composition of plant species mixtures grown at various N: P ratios and levels of nutrient supply. *Basic and Applied Ecology* 4: 453-466
- Hopkins, W.G., Hüner, N.P.A. 2004. *Introduction to Plant Physiology*. 3rd Ed. John Wiley and Sons Inc., New York, U.S.A.
- Hudson, R.O., Golding, D.L. 1997. Controls on groundwater chemistry in subalpine catchments in the southern interior of British Columbia. *Journal of Hydrology* 201: 1-20
- Hunt, R.J., Krabbenhoft, D.P., Anderson M.P. 1997. Assessing hydrogeochemical heterogeneity in natural and constructed wetlands. *Biogeochemistry* 39: 271-293
- Ito, M., Mitchell, M.J., Driscoll, C.T., Roy, K.M. 2005. Factors affecting acid neutralizing capacity in the Adirondack Region of New York: a solute mass balance approach. *Environmental Science and Technology* 39:4076-4081
- Jamestown ND: Northern Prairie Wildlife Research Centre Home Page
<http://www.npwr.usgs.gov/resource/1998/classwet/classwet.htm> (Version 04Dec98)
- Job, N., von Witt, C. 2008. *Basic identification guide to common wetland plants*. South African National Biodiversity Institute (SANBI), unpublished
- Jolly, I.D., McEwan, K.L., Holland, K.L. 2008. A review of groundwater-surface water interactions in arid/semi-arid wetlands and the consequence of salinity for wetland ecology. *Ecohydrology*, 1: 43-58
- Kadlec, R.H. 2006. Water temperature and evaporation in surface flow wetlands in hot arid climate. *Ecological Engineering* 26:4 328-340
- Kadlec, R.H. 1999. Chemical, physical and biological cycles in treatment wetlands. *Water Science and Technology* 40:3 37-44

- Karant, K.R. 1987. *Groundwater Assessment: development and Management*. Tata McGraw-Hill, London, U.K.
- Keddy, P.A. 2000. *Wetland ecology: principles and conservation*. Cambridge Studies in Ecology, South Eastern Louisiana University, U.S.A.
- Koerselman, W. M. B., Van Kerkhoven, J. T., Verhoeven A. 1993. Release of inorganic nitrogen, phosphorus and potassium in peat soils: effect of temperature, water chemistry and water level. *Biogeochemistry* 20:63-81
- Koerselman, W., Meuleman, F.M. 1996. The vegetation N:P ratio: a new tool to detect the nature of nutrient limitation. *The Journal of Applied Ecology* 33:6 1441-1450
- Kotze, D.C., Breen, C.M., Quinn, N. 1995. *Wetland losses in South Africa*. In *GI Cowan wetlands of South Africa*, Department of Environmental Affairs and Tourism, pp263-272
- Kotze, D.C., Marneweck, G.C., Batchelor, A.L., Lindley, D.S., Collins, N.B. 2005. *WET Ecoservices: a technique for rapidly assessing ecosystem services supplied by wetlands*. Water Research Commission, WRC, Pretoria, S.A.
- Krešić, N. 2007. *Hydrogeology and groundwater modelling*, CRC Press, London, U.K.
- Kröger, R., Holland, M.M., Moore, M.T., Cooper, C.M. 2007. Plant senescence: a mechanism for nutrient release in temperate agricultural wetlands. *Environmental Pollution* 146:114-119
- Larcher, W. 2003. *Physiological plant ecology: ecophysiology and stress physiology of functional groups* 4th Ed. Springer, Berlin, Germany
- Lisle, R.J. 1988. *Geological structures and Maps: a practical guide*. Pergamon Press, New York, U.S.A.
- Maasdorf, B.V. 1987. Contributions of associative N₂ fixation (acetylene reduction) in some grassland ecosystems in Zimbabwe. *Soil biology and biochemistry* 19:7-12
- Mainiero, R., Kazda, M. 2004. Effects of *Carex rostrata* on soil oxygen in relation to soil moisture. *Plant and Soil* 270:311-320
- Malan, H.L., Day, J.A. 2005. *Wetland water quality and the ecological reserve*. WRC Report No. 1311/1/05, Water Research Commission, S.A.
- Marschner, H. 1995. *Mineral Nutrition of Higher Plants* 2nd Ed. Academic Press Limited, London, U.K.
- Mayes, W.M., Younger, P.L., Aumonier, J. 2006. Buffering of alkaline steel slag leachate across a natural wetland, *Environmental Science and Technology* 40:1237-1243
- McClain, M.E. 2002. The application of ecohydrological principles for better water quality management in South American rivers and wetlands. In: *The Ecohydrology of South America rivers and wetlands*. *International Association of Hydrological Sciences Special Publication no.6*

McLatchey, G.P., Reddy, K.R. 1998. Regulation of organic matter decomposition and nutrient release in a wetland soil. *Journal of Environmental Quality* 27:5 1268-1274

Merck Chemical database, (2006) Darmstadt, GERMANY <http://fea.merck.de> on 19 August 2009

Michigan DNRE Natural Resources and Environment 2001.
<http://www.deq.state.mi.us/documents/deq-water-wetlands-idmanualchap2.pdf> On 4 March 2010

Miller, R.C., Zedler, J.B. 2003. Responses of native and invasive wetland plants to hydroperiod and water depth. *Plant Ecology* 167: 56-69

Millenium Ecosystem Assessment, 2005. <http://www.milleniumpassessment.org>

Minnesota Pollution Control Agency 1999. Environmental outcomes division: groundwater monitoring and assessment program
<http://www.pca.state.mn.us/water/groundwater/gwmap/index.html> on 20 January 2010

Mitch, W.J., Gosselink, J.G. 2007. *Wetlands*, 4th Ed. John Wiley and Sons Inc. New Jersey, U.S.A.

Mondi Wetland Program, 2008. URL <http://www.wetlands.org.za>

Moore, P.D., Chapman. S.B. 1986. *Methods in plant ecology*. 2nd Ed. Blackwell Scientific Publishers, Oxford, U.K.

Moreno-Casasola, P., Vázquez, G. 1999. The relationship between vegetation dynamics and water table in tropical dune slacks. *Journal of Vegetation Science* 10:4 515-524

Moser, K., Ahn, C., Noe, G. 2007. Characterization of microtopography and its influence on vegetation patterns in created wetlands. *Wetlands* 27:4 1081-1097

Murphy, J., Riley, J.P. 1962. A modified single solution method for the determination of phosphate in natural waters. *Analytica Chimica Acta* 27: 31-36.

National Water Act. No 36 of 1998. Government Gazette, South Africa

Newman, S., Pietro, K. 2001. Phosphorus storage and release in response to flooding: implications for Everglades's stormwater treatment areas. *Ecological Engineering* 18:23-38

Nuttle, W.K. 2002. Eco-hydrology's past and future in focus. *American Geophysical Union Eos* 83:205 211 212, pp. 1

Olde Venterink, H., Davidsson, T.E., Kiehl, K., Leonardson, L. 2002. Impact of drying and re-wetting on N, P and K dynamics in a wetland soil. *Plant and Soil* 243:119-130

Orzepowski, W., Pulikowski, K., 2008. Magnesium, calcium, potassium and sodium content in groundwater and surface water in arable lands in the commune (Gmina) of Kały Wrocławskie. *J. Elementol* 13: 4 605-614

Palmer, R.W., Turpie, J., Marnewick, G.C., Batchelor, A.L. 2002. *Ecological and economic evaluation of wetlands in the upper olifants river catchment, South Africa*. Water Research Commission WRC Report No 1162/1/02, S.A.

Palmer, T., Berold, R., Muller, N. 2004. *Environmental water quality in Water Resources Management*. Water Research Commission (WRC) Report no. TT217/04, S.A.

Patten, B.C., Doody, J. P. 1996. Review: wetland use, abuse and management. *Global Ecology and Biogeography Letters* 5:1 57-58

Pezeshki, S.R. 2001. Wetland plant response to soil flooding. *Environmental and Experimental Botany* 46: 299-312

Ponnamperuma, F.N. 1972. The chemistry of submerged soils. *Advances in Agronomy* 24:29-96

Potash & Phosphate Institute of Canada (PPIC)

URL:[http://www.ipni.net/ppiweb/ppinews.nsf/\\$webcontents/BFC425FCAE6ACE4E85256B90005BD114/\\$file/Flooded+Soils.pdf](http://www.ipni.net/ppiweb/ppinews.nsf/$webcontents/BFC425FCAE6ACE4E85256B90005BD114/$file/Flooded+Soils.pdf) on 20 January 2010

Rail, C.D 2000. *Groundwater contamination. volume I: sources and hydrology*, CRC Press, London, U.K.

Ramsar Convention Kampala 2005. *Guidelines for the management of groundwater to maintain wetland ecological character*, Resolution IX.1 Annex C ii URL: http://www Ramsar.org/key_guide_groundwater_e.pdf on 19 October 2009

Reddy, K.R., DeLaune, R.D. 2008. *Biogeochemistry of wetlands: Science and applications*, CRC Press, New York, U.S.A.

Reddy, K.R., Flaig, E.G., Graetz, D.A. 1996. Phosphorus storage capacity of uplands, wetlands and streams of the Lake Okeechobee Watershed, Florida. *Agriculture, Ecosystems and Environment* 59:203-216

Richardson, C.J., Marshall, P.E. 1986. Processes controlling movement, storage and export of phosphorus in a fen peatland. *Ecological Monographs* 56:4 279-302

Richter, B.D., Baumgartner, J.V., Powell, J., Braun, D.P. 1996. A method for assessing hydrologic alteration within ecosystems. *Conservation Biology* 10:4 1163-1174

Ridolfi, L., D'Odorico, P., Liao, F. 2006. Effect of vegetation-water table feedbacks on the stability and resilience of plant ecosystems. *Water Resources Research* 42:WO1201

Roberts, J. 2000. The influence of physical and physiological characteristics of vegetation on their hydrological response. *Hydrological Processes* 14:2885-2901

Rodriguez-Iturbe, I. 2000. Ecohydrology: hydrologic perspective of climate-soil-vegetation dynamics. *Water Resources Research* 36:3-9

Roets, W., Xu, Y., Raitt, L., Brendonck, L. 2008. Groundwater discharges to aquatic ecosystems associated with the Table Mountain Group (TMG) Aquifer: a conceptual model. *WaterSA* 34: 1. 77-87

- Schwirzer, A. 2006. *Geomorphic attributes of palustrine wetlands in the Upper Boesman River catchment, Kwazulu Natal*. PhD thesis, Department of Geography, Geoinformatics and Meteorology, University of Pretoria, Pretoria. S.A.
- Seelig, B., DeKeyser, S. 2006. *Water quality and wetland function in the northern prairie pothole region*. North Dakota State University, Fargo, ND 58105
- Shaver, G.R., Bret-Harte, M.S., Jones, M.H., Johnstone, J., Gough, L., Laundre, J., Chapin III, F.S. 2001. Species composition interacts with fertilizer to control long term change in tundra productivity. *Ecology* 82:113163-3181
- Smith, R.G.B., Brock, M.A., 2007. The ups and downs of life on the edge; the influence of water level fluctuations on biomass allocation in two contrasting aquatic plants. *Plant Ecology* 188:103-116
- Snowden (nee Cook), R.E.D., Wheeler, B.D. 1995. Chemical changes in selected wetland plant species with increasing Fe supply , with specific reference to root precipitate and Fe tolerance. *New Phytologist* 131:4 503-520
- Snyder, C.S. 2002. *Effects of soil flooding and drying on phosphorus reactions*. Regional Newsletter published by Potash & Phosphate Institute (PPI) and the
- Song, K., Zoh, K., Kang, H. 2007. Release of phosphate in a wetland by changes in hydrological regime, *Science of the Total Environment* 380:13-18
- Southern Africa online checklist* 2005. South African National Biodiversity Institute (SANBI) <http://posa.sanbi.org/specieslist.php?PostoptListType=1&optLifeform=Cyperoid&optSortOrder=Family+ASC&pgResult=1> on 15 October 2009
- Spectrum Analytic Inc* (2010) Agronomy Analysis Services http://www.spectrumanalytic.com/supoort/library/ff/Ca_Basics.htm on 20 January 2010
- Spooner, A., Carpenter, J., Smith, G. Spence, K. 2008. *Flora Base Flora the Western Australia flora: Watsonia meriana*. Department of Environment and Conservation, <http://florabase.calm.wa.gov.au/browse/profile/1567> on 16 October 2009
- Sutherson, S.S., Payne, F.C. 2005. *In situ remediation engineering*. CRC Press, London, U.K.
- Sutton, D. 2001. *Understanding groundwater*. Government of Alberta: agricultural and rural development, URL: [http://www1.agric.gov.ab.ca/\\$department/deptdocs.nsf/all/wwg406](http://www1.agric.gov.ab.ca/$department/deptdocs.nsf/all/wwg406) last reviewed Dec 12 2008
- Tainton, N.M., Bransby, D.I., Booysen, P.deV. 1976. *Common veld and pasture grasses of Natal*, Shuter and Shooter Publishers, Pietermaritzburg, S.A.
- Thinder-Smith, T.H. 2003. *The Levyns Guide to the plant genera of the Southwestern Cape*. University of Cape Town, Cape Town, S.A.
- Tiner, R.W. 1999. *Wetland indicators: a guide to wetland identification, delineation, classification and mapping*. CRC Press, New York, U.S.A.

- Titus, J.H. 1990. Microtopography and woody plant regeneration in a hardwood floodplain swamp in Florida. *Bulletin of the Torrey Botanical Club* 117:4 429-437
- Turner, R.K., Georgiou, S., Brouwer, R., Bateman, I.J., Langford, I.J. 2003. Towards an integrated environmental assessment for wetland and catchment management, *The Geographic Journal*, 169:2 99-116
- United Nations Environment Program (UNEP), 2009. *Manual for natural training program, Chapter 12: Electrical conductivity meter* URL: www.rrcap.unep.org/male/manual/national/chapter12
- U.S Department of Agriculture Natural Resource Conservation Service (NRCS) 1998. URL: <http://soils.usda.gov/use/hydric/intro.html> on 21/05/09
- Van der Valk, A.G. 1981. Succession in wetlands a Gleasonian approach. *Ecology* 62:3 688-696
- Van der Valk, A.G. 2006. *The biology of Freshwater Wetlands*. Oxford University Press, Oxford, U.K.
- Van Cleemput, O., Baert, L. 1984. Nitrite a key compound in N loss process under acid conditions. *Plant and Soil* 76: 233-241
- Van Cleemput, O., Samater, A.H. 1996. Nitrite in soils: accumulation and role in formation of gaseous N compounds. *Fertilizer Research* 45: 81-89,
- Verhoeven, J.T.A., Koerselman, W., Meuleman, A.F.M. 1996. Nitrogen- or phosphorus-limited growth in herbaceous mire vegetation: relations with atmospheric inputs and management regimes. *Trends in Ecology and Evolution* 11:12 494-497
- Verhoeven, J.T.A., Schmitz, M.B. 1991. Control of plant growth by nitrogen and phosphorus in mesotrophic fens. *Biogeochemistry* 12:2 135-148
- Vermeer, J.G., Berendse, F. 1983. The relationship between nutrient availability, shoot biomass and species richness in grassland and wetland communities. *Plant Ecology* 53:2 121-126
- Vivian-Smith, G. 1997. Microtopographic heterogeneity and floristic diversity in experimental wetland communities. *Journal of Ecology* 85:71-82
- Vollesen, I.K. 1998. *Catalogue of vascular plants*. Kgl Danske Videnskabernes Selskab, London, U.K
- Walmsley, R.D. 1988. *A description of the wetland research program*. South African National Scientific Program Report (SANSP) No: 145, S.A.
- Wassen, M.J., Barendregt, A., Palczynski, A., de Smidt, J.T., de Mars H. 1990. The relationship between fen vegetation gradients, groundwater flow and flooding in an undrained valley mire at Biebrza, Poland. *The Journal of Ecology* 78:4 1106-1122
- Wassen, M.J., Grootjans, A.P. 1996. Ecohydrology an interdisciplinary approach for wetland management and restoration. *Vegetatio* 126:1-4

Water Research Commission (WRC), 2009. Wetlands: tools for effective management and rehabilitation, Technical Brief URL: www.wrc.org.za

Werner, K.J., Zedler, J.B. 2002. How sedge meadow soils, microtopography and vegetation respond to sedimentation. *Wetlands* 22:3 451-466

Wheeler, B. 1999. Water and plants in freshwater wetlands. In: Wilby RL, Baird AJ (eds) *Ecohydrology: plants and water in terrestrial and aquatic environments*. Routledge, London, U.K, pp. 127-180

Wierda, A., Fresco, L. F. M., Grootjans, A.P., van Diggelen R. 1997. Numerical Assessment of plants species as indicators of the groundwater regime. *Vegetation Science* 8:5 707-716

Willby, N.J., Pulford, I.D., Flowers, T.H. 2001. Tissue nutrient signatures predict herbaceous-wetland community responses to nutrient availability. *New Phytologist* 152:3 463-481

Woo, I., Zedler J.B. 2002. Can nutrients alone shift a sedge meadow toward dominance by the invasive *Typha x Glauca*? *Wetlands* 22:3 509-521

Wright, A.L. 2009. *Environmental consequences of water withdrawals and drainage of wetlands*, The Institute of food and agricultural sciences (IFAS), SL302

Wright, D.J., Otte, M.L. 1999. Wetland plant effects on the biogeochemistry of metals beyond the rhizosphere. *Biology Environment: proceedings of the Royal Irish Academy* 99B:1 3-10

Wu, Y. 2005. *Groundwater recharge estimation in table mountain group aquifer systems with a case study of Kammanassie area*, PhD Thesis, Department of Earth Science, University of the Western Cape, Bellville, South Africa

Yabe, K., Onimaru, K. 1997. Key variables controlling the vegetation of a cool temperate mire in Northern Japan. *Journal of Vegetation Science* 8:2 29-36

Younger, P.L. 2006. *Groundwater in the environment: an introduction*. Blackwell Publishing, Oxford, U.K.3.5

Zalewski, M. 2000. Ecohydrology - the scientific background to use ecosystem properties as management tools toward sustainability of water resources. *Ecological Engineering* 16: 1-8

Zalewski, M. 2002. Ecohydrology - the use of ecological and hydrological processes for sustainable management of water resources. *Hydrological Sciences-Journal-des Sciences Hydrologiques* 47:5

Zalewski M., Santiago Fandino V., Neate J. 2003. Energy, water plant interaction: "green feedback" as a mechanism for environmental management and control through the application of phytotechnology and ecohydrology. *Hydrological Processes* 17:2753-2767

Appendices

Appendix I Species names and abbreviations recorded using the Braun-Blanquet method

Species name	Abbreviation used
<i>Acacia saligna</i>	A.sal
<i>Calopsis paniculata</i>	C.pan
<i>Carpha glomerata</i>	C.glom
<i>Clifortia strobilifera</i>	C.stro
<i>Cyperus denudatus</i>	C.den
<i>Cyperus sp.</i>	Cyperus sp.
<i>Epishoenus gracilis</i>	E.grac.
<i>Epishoenus sp.</i>	Epi sp.
<i>Ficina hirsute</i>	F.hir
<i>Helichrysums sp.</i>	Hel.sp

<i>Hydrocotyle verticillata</i>	H.ver
<i>Isolepus digitata</i>	I.dig
<i>Juncus effuses</i>	J.eff
<i>Juncus kraussii</i>	J.kra
<i>Mentha aquatica</i>	M.aqu
<i>Nymphoides indica</i>	N.ind
<i>Othonna .sp.</i>	Oth.sp
<i>Paspalum urvillei</i>	P.urv
<i>Passerina sp.</i>	Pass.sp
<i>Pennisetum macrourum</i>	P.mac
<i>Persicaria decipiens</i>	P.dec
<i>Prionium serratum</i>	P.ser
<i>Pteridium aquilinum</i>	p.aqu

<i>Rubus cuneifolius</i>	R.cum
<i>Searsia angustifolia</i>	S.ang
<i>Sonchus oleraceus</i>	S.ole
<i>Syncarpha sp.</i>	Syn
<i>Thelypteris palustris</i>	T.pal
<i>Typha capensis</i>	T.cap
<i>Watsonia meriana</i>	W.mer
<i>Zantedeschia aethiopica</i>	Z.aeth



UNIVERSITY of the
WESTERN CAPE