

Comparison of the sutherlandioside B levels in two commercially available *Sutherlandia frutescens* preparations and the effect of elevated temperature and humidity on these levels

Ashton Edward Joseph

A thesis submitted in partial fulfillment of the requirements for the degree of Magister Pharmaceuticae at the School of Pharmacy, University of the Western Cape.



Supervisor: Prof J. A. Syce

School of Pharmacy

University of the Western Cape

Bellville

South Africa

November 2009

Comparison of the sutherlandioside B levels in two commercially available *Sutherlandia frutescens* preparations and the effect of elevated temperature and humidity on these levels

Keywords

Sutherlandioside B (SU-B or SU1)

Sutherlandia frutescens

Phyto Nova Sutherlandia SU1™ tablets

Promune™

HPLC assay

Cycloartane glycoside

Herbal solid dosage forms

Elevated temperature

Relative humidity

Acid hydrolysis



DECLARATION

I, Ashton Edward Joseph, declare that “**Comparison of the sutherlandioside B levels in two commercially available *Sutherlandia frutescens* preparations and the effect of elevated temperature and humidity on these levels**” is my own work, that it has not been submitted for any degree or examination to any other University, and that all the sources that I have used or quoted have been indicated and acknowledged by means of complete references.

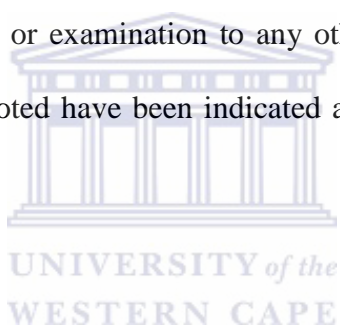

Signature:

November 2009

DEDICATION

To my Lord and Saviour, who enables me to do all things through

Christ who strengthens me. (Phil. 4:13)

UNIVERSITY *of the*
WESTERN CAPE

ACKNOWLEDGEMENTS

I would like to express my sincere gratitude and appreciation to the following people and institutions for their contribution:

My family: Dad, Mom, Conran and Jenéad, for all their support, encouragement and believing in me. Without you all, I wouldn't be here and this wouldn't be possible.

Prof. J. A. Syce, my supervisor, for his inspiration, motivation, guidance, advice, patience and the supervision throughout this project.

To my extended family, Ousus, Aunt Judy, Uncle Shuan, Aunty Dollie, Melanie, Fredeline, Shane, Jennifer, Samantha, Donnite and Samantha J for your prayers and support throughout the years.

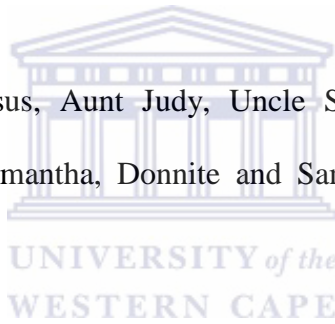

A special word of thanks and gratitude to Dr. Babajide Jejileli for his expertise and help.

Ms. Gene Stone, for all the logistics and assistance and making sure that we meet all the deadlines. Mr. André Braaf and Dr. Samantha Thamburan, for the technical support and advice and finally all my colleagues, Meggan Hess, Brian, Darren, Miao-juei, Terisha, Sethu, Tania Mbank, James Mukinda, Donaghue, for their support, assistance and for all the good times. I thank you. The staff of the School of Pharmacy and SAHSMI (UWC) and to all those who participated either directly or indirectly, thank you for the support.

CONTENTS

Keywords	ii
DECLARATION	iii
DEDICATION	iv
ACKNOWLEDGEMENTS	v
CONTENTS	vi
LIST OF TABLES	xi
LIST OF FIGURES	xii
LIST OF ABBREVIATIONS	xiv
SUMMARY	xv
Chapter one: INTRODUCTION	1
Chapter two: LITERATURE REVIEW	6
2.1 Introduction	6
2.2 Medicinal plants	6
2.3 Taxonomy of <i>Sutherlandia frutescens</i>	7
2.3.1 Vernacular names and nomenclature	7
2.3.2 Botanical description and distribution	8
2.4 Pharmacological properties and toxicology of <i>Sutherlandia frutescens</i>	9
2.4.1 Cancer	10
2.4.2 HIV and AIDS	11
2.4.3 Diabetes	12
2.4.4 Inflammation, pain and wounds	13
2.4.5 Stress	14
2.4.6 Other indications	14



2.4.7 Toxicology	14
2.5 Chemistry	15
2.5.1 Free amino acids	15
2.5.2 Non protein amino acids	16
2.5.3 GABA	16
2.5.4 Pinitol	17
2.5.5 Flavanoids	17
2.5.6 Saponins	18
2.6 Analytical methods suitable for sutherlandioside B analysis	21
2.7 Validation of a HPLC assay	24
2.7.1 Specificity	25
2.7.2 Accuracy	26
2.7.3 Repeatability	26
2.7.4 Precision	27
2.7.5 Reproducibility	27
2.7.6 Limit of detection (LOD)	27
2.7.7 Limit of quantification (LOQ)	28
2.7.8 Linearity and range	28
2.7.9 Ruggedness	29
2.7.10 Robustness	29
2.7.11 System suitability	30
2.8 Commercially available <i>S. frutescens</i> products	31
2.9 Effect of elevated temperature and humidity	33
2.10 Acid- hydrolysis	35



Chapter three: PLAN OF WORK	36
3.1 Introduction	36
3.2 Objectives	36
3.3 Hypothesis	36
3.4 Study approach	37
3.4.1 Selection of <i>Sutherlandia</i> products to test	37
3.4.2 Selection of Sutherlandioside B as marker compound	38
3.4.3 Development and validation of a HPLC assay for SU-B.	39
3.4.4 Determination of the effect of elevated temperature and humidity on the Sutherlandioside B levels in the Phyto Nova Sutherlandia™ tablets and the Promune™ capsules	40
Chapter four: MATERIALS AND METHODS	41
4.1 Introduction	41
4.2 Chemicals and reagents	41
4.3 Equipment and instruments	42
4.4 Experimental methods and procedures	43
4.4.1 Collection, identification of <i>S. frutescens</i> plant raw material	43
4.4.2 Extraction and isolation of sutherlandioside B	44
4.4.3 Identification of SU-B by TLC, HPLC and LC-MS methods	45
4.4.4. HPLC assay for determination of SU-B levels	48
4.4.4.1 Preparation of standard solutions	48
4.4.4.2 General HPLC procedure	48
4.4.4.3 Validation of the HPLC assay	49

4.4.4.4 Determination of SU-B levels in the <i>Sutherlandia</i> plant raw material and the two commercial products	50
4.4.5 Determination of the stability of SU-B in Phyto Nova™ tablets and Promune™ capsules	51
4.4.6 Determination of the stability of SU-B under hydrolytic conditions: Acid-induced degradation	52
Chapter Five: RESULTS AND DISCUSSIONS	53
5.1 Introduction	53
5.2 Collection, extraction and isolation of SU-B from plant material	53
5.3 Identification of isolated SU-B from <i>S. frutescens</i>	54
5.4 Development and validation of a HPLC assay for SU-B in the plant material	59
5.4.1 Development of HPLC assay	59
5.4.2 Validation of the HPLC assay	60
5.5 Comparison of the sutherlandioside B levels and profiles in the Phyto Nova™ tablets and Promune™ capsules	65
5.6 The effect of elevated temperature and relative humidity on the SU-B levels in the two commercial products	69
5.7 The effect of acid hydrolysis on the SU-B levels in the two commercial products	73

Chapter Six: CONCLUSIONS AND RECOMMENDATIONS	77
REFERENCES	81
APPENDICES	91
Brief introduction of the author	95



LIST OF TABLES

Table 1:	Mass spectra of SU-B identified using a LC-ESI- MS method	59
Table 2:	Key-fragment analysis of SU-B standard by LC-ESI-TOF	59
Table 3:	Summary of validation parameters for the HPLC assay	63
Table4:	Intra-and Inter-day accuracy for SU-B in <i>S. Frutescens</i>.	64
Table 5:	SU-B content in the two commercial products under ambient and elevated temperature and environmental humidity	70



LIST OF FIGURES

Figure 1:	Chemical structure of sutherlandioside B	21
Figure 2:	A flow scheme for HPLC	23
Figure 3:	Two commercially available <i>Sutherlandia</i> products	32
Figure 4:	TLC plates of the <i>n</i>-BuOH fraction of <i>S. frutescens</i> developed under different mobile conditions.	55
Figure 5:	TLC plate of the isolated sutherlandioside B with mobile phase CHCl₃: MeOH (9:1).	55
Figure 6 A -C:	Representative HPLC chromatogram, UV spectra and peak purity of the isolated SU-B standard at 260nm	56
Figure 7:	Representative HPLC chromatogram of isolated SU-B at 349nm	57
Figure 8:	Total ion chromatogram of the isolated SU-B solution using LC-ESI-TOF method	58
Figure 9:	MS-MS fragmentation profile for peak at retention time 3.723 minutes	58
Figure 10:	Chromatogram of <i>S. frutescens</i> plant material at 260 nm	62
Figure 11:	Chromatogram of <i>S. frutescens</i> plant material spiked with the isolated SU-B standard solution at 260nm	62

Figure 12:	Standard curve peak area versus concentration of the sutherlandioside B levels in <i>S. frutescens</i>.	64
Figure 13:	Representative HPLC chromatogram and UV spectra of SU-B in the Phyto Nova Sutherlandia SU1™ tablets	67
Figure 14:	Representative HPLC chromatogram and UV-spectra of SU-B in the Promune™ capsules at 260nm	68
Figure 15:	SU-B concentration in the two commercial products under ambient and elevated temperature and environmental humidity conditions	71
Figure 16:	Representative HPLC chromatogram of an acid-hydrolyzed solution of Phyto Nova™ tablet powder.	75
Figure 17:	Representative HPLC chromatogram of an acid-hydrolyzed solution of the Promune™ capsule powder.	75

LIST OF ABBREVIATIONS

SU-B or SU1	Sutherlandioside B
HPLC	High performance liquid chromatography
RH	Relative humidity
mg/mL	Milligram per milliliter
µg/mL	Microgram per milliliter
w/w	Weight per weight
%w/w	Percentage weight per weight



SUMMARY

Sutherlandia frutescens (tribe Galegeae, Fabaceae), is a popular medicinal plant traditionally used in South Africa. In 2000, a company called Phyto Nova (Pty) Ltd. initiated large-scale cultivation and contract manufacturing of tablets, made from the powdered herb (i.e. thin stems and leaves). Most of these commercial *Sutherlandia* solid dosage forms are made from the dried leaf powder but recently a new product, viz. Promune™ capsules, made from a freeze-dried aqueous extract, came on the market and was claimed to be “better” as it mimics the traditional tea. However, the pharmaceutical quality and stability of these preparations have not yet been investigated.

The objectives of this study were firstly, to develop a validated stability-indicating HPLC assay for sutherlandioside B (SU-B); secondly, to compare the SU-B levels in the two commercially available *Sutherlandia* products viz, the Phyto Nova *Sutherlandia* SU1™ tablet and the Promune™ capsule, and, thirdly, to determine the effect of elevated temperature and humidity as well as acid hydrolysis on the SU-B levels in these two products.

To realize these objectives, the major glycoside, sutherlandioside B (SU-B), of the plant *S. frutescens* was firstly extracted with methanol and isolated using silica gel column chromatographic fractionation. Then an HPLC method for its quantification in the plant material was developed and validated and, finally, applied to determine the SU-B levels

in these two commercial *Sutherlandia* products and the effect that elevated temperature, humidity and acid hydrolysis have on these SU-B levels.

The cycloartane glycoside, sutherlandioside B was successfully isolated and its identification established using a LC-MS method. A simple, precise reverse phase HPLC-UV method that used a reverse phase Discovery® C-18 column, a mixture of water/acetonitrile with formic acid as mobile phase and a detection wavelength of 260 nm were used for the isolation and detection of the SU-B peak. The developed method was highly reproducible and linear over range 22-330µg/ml, with a limits of detection (LOD) and limits of quantification (LOQ) of 0.5 and 22µg/ml, respectively. The intra- and inter day variation was lower than 3.0% and the within day CVs for the replicates (n=6) at two different concentrations (22 and 55 µg) was 1.23%.

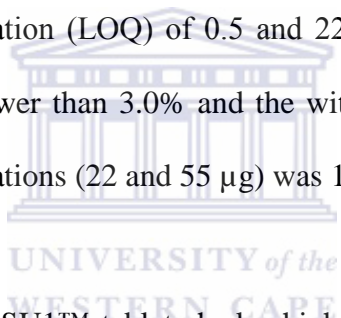

The Phyto Nova Sutherlandia SU1™ tablets had a higher average SU-B concentration than the Promune™ capsules, i.e. 1.73 ± 0.013 µg/mg versus 1.523 ± 0.016 µg/mg (n =6). The average daily dose of SU-B in the Phyto Nova Sutherlandia SU1™ tablets was thus significantly higher than that in the Promune™ capsules (i.e. 519 µg vs. 137.07 µg, respectively, p = ??).

When stored at 40⁰C and 70% relative humidity for four weeks the SU-B in the Phyto Nova Sutherlandia SU1™ tablets, stored sealed and unsealed, decreased by 38.27% and 41.68 %, respectively while that in the Promune™ capsules, stored sealed and unsealed, decreased by 34.08% and 35.13% respectively.

Collectively, the results of this study indicate that instabilities such as degradation by elevated temperature, humidity and acid can be identified using the developed HPLC assay and can thus be used to monitor *Sutherlandia* product stability. This study also provides valuable preliminary data on the stability profile of *Sutherlandia* tablets and capsules using SU-B as marker compound that could be useful for any future quality control studies on this medicinal plant.



CHAPTER ONE

INTRODUCTION

Today in South Africa, most of the population in urban, as well as smaller rural communities, are still reliant on medicinal plants for their health care needs (Fennell *et al.*, 2004). One such medicinal plant used in South Africa is *Sutherlandia frutescens*. Traditionally *S. frutescens* is used for a wide diversity of ailments, among others, the treatment of stomach ailments, diabetes, internal cancers, stress, fever and wounds. Recently *S. frutescens* was used as a tonic by AIDS patients, and claimed to result in an improvement of mood and appetite, weight gain, improved CD4 counts and reduced viral loads (Gericke *et al.*, 2001; Morris, 2001; Chaffy and Stokes, 2002; Van Wyk, 2004).

In recent years *Sutherlandia frutescens* has received a marked increase in both scientific and commercial attention in recent years. Small-scale cultivation and commercialization of *Sutherlandia frutescens* essentially started in 1990, when air-dried leaves were supplied to a health shop in Port Elizabeth in the Eastern Cape Province. In 2000 a company called Phyto Nova (Pty) Ltd. initiated large-scale cultivation and contract manufacturing of tablets made from powdered herb (i.e. thin stems and leaves). Several *Sutherlandia* preparations, made from different raw plant material, are now commercially available in South Africa. These commercially available *Sutherlandia* preparations are found in various dosage forms including tablets, capsules, traditional tea, gel and aqueous infusion or decoction. The pharmaceutical quality of these preparations has however, not yet been investigated and they are not registered with the South African regulatory

authority, viz. the Medicine Control Council (MCC). In fact, these medicines cannot be registered with the MCC, since the latter at present, do not have the appropriate regulations, guidelines, approval and review procedures and product specification guidelines in place that can be applied for such herbal product registration. In particular, there are no guidelines and set protocols for the determination of the stability and expiry dates of these products.

Most of the currently available solid dose (i.e. capsule or tablet) dosage forms of *Sutherlandia* (e.g. Phyto Nova Sutherlandia SU1™) contain the dried leaf powder as the active plant raw material. Recently a preparation, viz Promune™, containing the dried aqueous extract of *Sutherlandia*, became commercially available in capsule form. In the package insert for this product, it is claimed that it is closer to the traditional dosage form of the plant and thus “better”. However, it is not really clear how this product compares in terms of chemical composition, efficacy and *in vivo* bioavailability of its active constituents, with the equivalent capsule(s) containing the dried leaf powder.

Indeed a full pharmaceutical evaluation of both these preparations, i.e. those containing the dry leaf powder or aqueous extract of the plant, need to be done. In particular, it is unclear if or how the stability (and hence the expiry date) of these preparations are established. Moreover, there appears to be no product stability data available to ascertain whether the assigned expiry dates are accurate, and, therefore, the absolute quality of these medicinal preparations are unknown.

To establish the stability of the commercially available *Sutherlandia* capsules and tablets the availability of a stability- indicating assay for a suitable marker compound(s) in the *Sutherlandia* products is essential. It is known that *S. frutescens* contains canavanine, GABA, flavanoids and saponins, which may be responsible for some of the plants actions (Tai *et al.*, 2004), but little information is available on the pharmacodynamic (esp. mechanism of action) and pharmacokinetic properties of the active constituents in these plant preparations. Scientifically, it could be assumed that the activities of the plant are due to the bio-active ingredients it contains (Muganga, 2004) and its constituents. Saponins in particular, could thus contribute to the activity, and therefore serve as biomarker for the characterization of the plant raw material and the assessment of the quality of these *Sutherlandia* preparations.

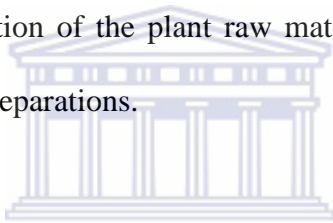

Saponins are glycosides of 27-carbon atom steroids or 30-carbon atom triterpens. Triterpene compounds are arranged in a 4-5 ring configuration of 30 carbons with several oxygens attached. Saponins are characterized by its bitter taste and ability to hemolyze red blood cells. The saponins in *S. frutescens* could be responsible for the plants immunomodulatory effect, which is evident in its use in HIV/ AIDS, TB and cancer patients. Furthermore, the use of *Sutherlandia* for hot flushes and irritability in menopause could be due to the production of the synthetic hormone progesterone after chemical degradation of saponins (Klein, 2004; Attele *et al.*, 1999; Lee *et al.*, 2003). Triterpene glycosides were first detected in *Sutherlandia microphylla* leaves by Brümmerhof (1969) and Viljoen (1969) but the chemical structures were not determined. Gabrielse (1996) isolated a pure compound (later called SU1 or sutherlandioside B) from

extracts of *Sutherlandia frutescens*. Moshe (1998) reported a complex pattern of triterpenes in the various species and forms of *Sutherlandia*, with limited variation within populations but large differences between populations. Recently, four new cycloartane glycosides, sutherlandiosides A, B, C and D were isolated from the medicinal plant, *S. frutescens* (Fu *et al.*, 2008). These compounds, in particular the major glycoside, Sutherlandioside B, may serve as chemical markers for the commercial dietary supplements prepared from this herbal medicine.

Triterpenoids, more specifically, Sutherlandioside B (or SU1), the major cycloartane triterpene glycoside of the plant *S. frutescens* can be assayed using gas chromatography (GC), high performance liquid chromatography (HPLC) and thin layer chromatography (TLC). HPLC is the method of choice for the analysis, because of its versatility, precision, high speed separation and sensitivity to low concentrations and relatively low cost. This technique, coupled with various detectors (e.g. diode array, UV and ELSD detectors and Mass spectrometer) provides specificity in detection and compatibility with a wide range of organic solvents miscible with water, which should ease any solubility problems with the saponins. In addition, HPLC offers advantages of high reproducibility and repeatability of data, thus leading to reliable results. HPLC would thus be an eminently suitable method to employ as a stability indicating assay for the major glycoside, sutherlandioside B in commercially available *Sutherlandia* plant materials. It will also be used to ascertain whether monitoring of SU B levels can be used to establish the relative pharmaceutical quality of commercially available solid oral dosage forms of *Sutherlandia*.

Given the above arguments, the objectives of this study were to:

1. develop a validated stability-indicating assay for the determination of sutherlandioside B in *S. frutescens* plant material and products,
2. identify and quantify the levels of sutherlandioside B present in commercially available products and
3. compare the effect of elevated temperature and environmental humidity as well as acid hydrolysis on the levels and profiles of sutherlandioside B in the Promune™ capsules, *versus* that in the Phyto Nova Sutherlandia SU1™ tablets.

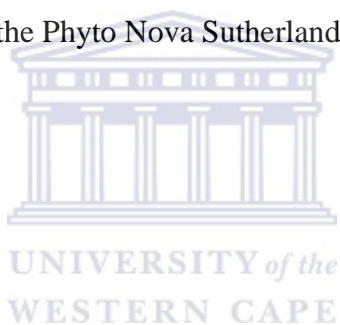

CHAPTER 2

LITERATURE REVIEW

2.1 Introduction

In this chapter an overview is presented of the medicinal plant, *Sutherlandia frutescens*, and its uses, pharmacology, toxicology and chemistry are reviewed. In particular, saponins and triterpenoid saponins and more specifically the cyclo-artane glycoside, sutherlandioside B, which could be used as marker compound for the characterization and the determination of the pharmaceutical quality of these commercially available preparations, are discussed. In addition the merits of analytical methods suitable for sutherlandioside analysis such as High Performance Liquid Chromatography (HPLC), Thin Layer Chromatography (TLC), LC-MS coupled with UV, IR, diode array and ELSD detectors are reviewed. The two commercially available *Sutherlandia* products, chosen upon, as well as the effect of elevated temperature, humidity and acid hydrolysis on the SU-B levels in these products are discussed.

2.2 Medicinal plants

Medicinal plants are plants in which one or more of its parts contain substances that can be used for therapeutic purposes, or which is a precursor for the synthesis of a direct therapeutic agent. Medicinal plant products in various forms have for many years been available to treat disease in both developing and developed countries, and are an important part of the culture and tradition of African people. Besides their cultural significance, medicinal plants are more accessible and affordable (Fennel *et al.*, 2004).

Presently, the quantity and quality of data on the safety and efficacy of traditional medicines are far from sufficient to meet the criteria needed to support their use worldwide. Therefore, with the recent advancement in research technology, the evaluation of these medicinal plants is therefore a necessity.

One very popular medicinal plant, indigenous to South Africa, and one in which there is a marked increase in use, especially commercial use, and where there is a lack of appropriate scientifically based information on its pharmaceutical quality, is evident in *Sutherlandia frutescens*.



2.3 Taxonomy of *Sutherlandia frutescens*

2.3.1 Vernacular names and nomenclature

Sutherlandia frutescens is one of the best known medicinal plants in the ethnobotanical world, and it is still used today in South Africa by people of different cultures. It is popularly known as cancer bush, *Sutherlandia*, balloon pea, and turkey flower (English), “*umnwele, insiswa*” (Xhosa and Zulu), “*musa-pelo, musa-pelo-oa-nòka, motlepelo*” (Sesotho) and “*kankerbossie, gansies, grootgansies, wildekeur(tjie), keurtjie, kalkoen(tjie)bos, kalkoenblom, belbos, kalkoenbelletjie, klapperbos, jantjie-bêrend, bitterbos, eendjies, hoenderbelletjie*” (Afrikaans). *Sutherlandia frutescens* belongs to:

- Division : Magnoliophyta
- Class : Magnoliopsida
- Order : Fabales
- Family : Fabaceae
- Subfamily : Faboideae
- Tribe : Galegeae
- Genus : *Sutherlandia* and
- Species : *S. frutescens*

(Van Wyk, and Gericke, 2000)



2.3.2 Botanical description and distribution

The genus *Sutherlandia* is so closely related to *Lessertia* that some botanists consider that it should be sunk in to *Lessertia* (Goldblatt and Manning, 2000). This species is sometimes called *Lessertia frutescens*. The genus *Sutherlandia* was named after James Sutherland, in the 1639- 1719, first superintendent of the Edinburgh Botanic Garden. The genus *Lessertia* is named after Jules Paul Benjamin de Lessert, 1773- 1847, a French industrialist, banker, amateur botanist and owner of an important private herbarium used by De Candolle. The species name *frutescens* means bushy in Latin. *Sutherlandia frutescens* is an attractive small, soft wooded shrublet, 0.5 to 1 m in height. The leaves are pinnately compound. The leaflets are 4-10 mm long, grey-green in colour, giving the bush a silvery appearance and have a very bitter taste. The flowers are orange-red, up to

35 mm long and are carried in short racemes in the leaf axils at the tips of the branches in spring to mid-summer (September- December). The wing petals are very small and are concealed in the calyx and the standard petal is much shorter than the keel. The flowers are not typical “pea” flowers. Lastly, the fruit is a large, bladder-like, papery inflated pod and is almost transparent (Van Wyk and Gericke, 2000).

Sutherlandia frutescens occurs naturally throughout the dry parts of South Africa, in the Western Cape and up the west coast as far north as Namibia and into Botswana, and in the western Karoo to Eastern Cape. It shows remarkable variation within its distribution (Van Wyk and Gericke, 2002). *Sutherlandia* can have significant biological effects that may be useful or harmful.

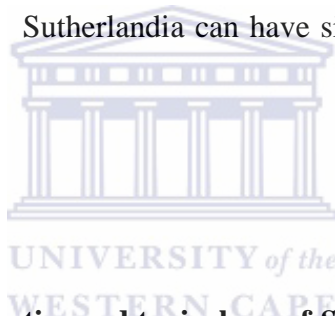

2.4 Pharmacological properties and toxicology of *Sutherlandia frutescens*

Sutherlandia frutescens is one of the most talked about plants in the ethno-botanical world, because of its strong reputation as a cure for cancer, and now increasingly, as an immune booster in the treatment of HIV/AIDS. Research on its properties is ongoing. It is known as a “cure all” remedy because of its use to treat a wide range of ailments. Traditionally it was used mainly as a decoction for the washing of wounds, bathing of the eyes to treat eye troubles and internally to bring down fever. It is also used to treat internal cancers, diabetes mellitus, respiratory disorders such as colds, flu, asthma, bronchitis, anti-inflammatory disorders such as rheumatism, rheumatoid and osteoarthritis, gastro-intestinal conditions such as diarrhoea, dysentery, stomach ailments,

heartburn and peptic ulcers. Additionally, it is used in the treatment of mental and emotional stress, including irritability, anxiety and depression and as a gentle tranquillizer. It is also used as a bitter tonic to aid digestion and to improve appetite (Van Wyk and Gericke, 2000; Roberts, 1990). *S.frutescens* has become widely known as cancer bush, because of the reported use by Khoi-San and Cape Dutch people against internal cancers. Below follows a more detailed discussion on the most common uses of *Sutherlandia* for cancer, HIV/AIDS, diabetes, inflammation, pain and wounds and stress.

2.4.1 Cancer

Anecdotal evidence exists of cancer patients who experienced an improved quality of life and survived for much longer than expected after treatment with *Sutherlandia* (Van Wyk *et al.*, 2000; C. Albrecht, 2008). Clinical evidence for the reduction of fatigue in cancer patients was presented by Grandi *et al.*, (2005). It can be assumed that the anticancer activity of the plant is due to its chemical constituents. One such chemical constituent of the plant *S. frutescens* is the major leaf metabolite, canavanine (known for its anti-cancer activity). Therefore, the discovery of canavanine in *S. frutescens* seems to be more than a coincidence, although concentrations required for cancer cell kill *in vivo* would also be toxic and no toxicity was found (Seier *et al.*, 2002). It was also suggested that canavanine may play a role in the antiproliferative effects, but that some other factors must also be involved, because addition of arginine (antidote for canavanine) did not abrogate the antiproliferative effect. In addition, it is also known that the major triterpenoids, sutherlandioside B, of the plant *Sutherlandia frutescens* are structurally closely related to cyclo-artane type triterpenoids that have proven cancer chemo

preventive activity (Kikuchi *et al.*, 2007). Tai *et al.*, (2004) using ethanolic extracts, provided the first *in vitro* evidence of anti-cancer effects by showing a concentration dependent 50% inhibition of proliferation of MCF7, MDA-MB-468, Jurkat and HL60 cells. Na *et al.*, (2004) reported that methanol extracts of *Sutherlandia* inhibited the DNA binding of NF- κ B activated by 12-O-tetradecanoylphorbol-13-acetate (TPA) in MCF10A human breast epithelial cells in a dose-dependent manner. They concluded that the inhibition of TPA-induced COX-2 expression through suppression of DNA binding of NF- κ B may contribute to chemo preventive or chemo protective activity in *Sutherlandia*. Chinkwo (2005) demonstrated that aqueous whole plant extracts induced apoptosis in neoplastic cells, notably cervical carcinoma and CHO (Chinese Hamster Ovary cells) cell lines. The possibility that canavanine is not the only active compound is supported by Kikuchi *et al.*, (2007), who studied the cancer chemo preventive activity of 48 natural and semi-synthetic cyclo-artane type triterpenoids. Many of the compounds (so-called astragalosides) are known from the genus *Astragalus* L., also a member of the tribe *Galegeae* and related to *Sutherlandia*. The most powerful inhibitory effects in an *in vivo* mouse skin carcinogenesis were found in cycloartanes with hydroxylation at C-24 and with a 3-oxo group. This configuration is present in SU1 or sutherlandioside B, the main cyclo-artane of the commercial type of *Sutherlandia* (Van Wyk *et al.*, 2007) and could be responsible with canavanine for the plants anticancer activity.

2.4.2 HIV and AIDS

Sutherlandia tablets, used as a tonic by AIDS patients, resulted in an improvement of mood and appetite, weight gain, improved CD4 counts and reduced viral loads (Gericke

et al., 2001; Morris, 2001; Chaffy and Stokes, 2002; Van Wyk, 2004). These claims have led to a NIH NCAM-sponsored clinical study to evaluate the possible effects of *Sutherlandia* on cachexia (the muscle-wasting effects seen in patients with cancer, tuberculosis and AIDS). A phase 1 study has shown that *Sutherlandia* is well tolerated and that it showed no significant side effects (Johnson *et al.*, 2007). A phase 2 study is said to be currently underway. It has been speculated that *Sutherlandia* triterpenoids might have cortimimetic activity besides the anticipated bitter tonic (amara) effect (Van Wyk and Wink, 2004). *In vitro* experiments of the effects of organic and aqueous extracts of *Sutherlandia* on HIV target enzymes (including HIV reverse transcriptase) by Harnett *et al.*, (2005) and Bessong *et al.*, (2006) showed that there are some compounds in aqueous extracts responsible for inhibitory effects. Canavanine is an inhibitor of nitric oxide synthase and has potential for the treatment of septic shock (Anfossi *et al.*, 1999; Levy *et al.*, 1999), a condition associated with advanced stages of AIDS. The lack of inhibition of nitric oxide secretion is concentration related (Tai *et al.*, 2004). In a review of available evidence for the value of *Hypoxis* and *Sutherlandia* in treating HIV, Mills *et al.*, (2005) noted the absence of clinical trials and warned against possible interactions with antiretroviral drugs.

2.4.3 Diabetes

Moshe (1998) and Van Wyk *et al.*, (2000) proposed that the high levels of pinitol in *Sutherlandia* leaves as a plausible rationale behind the traditional anti-diabetic use. A review of the limited available pharmacological evidence was presented by Sias (2004), who argued that L-canavanine, other amino acids such as L-arginine and pinitol may contribute to anti-diabetic effects, either directly or via anti-inflammatory and nitric oxide

-inhibitory activity. The anti-inflammatory and nitric oxide -inhibitory activity of *Sutherlandia* extracts could counteract the insulinitis of autoimmune diabetes by protecting pancreatic beta-cells against reactive oxygen radicals of which nitric oxide could be one. Bates *et al.*, (2000) have shown that pinitol exert an insulin-like effect by reducing blood sugar levels in diabetic mice, however a preliminary study of the clinical benefits of pinitol in obese and mild type 2 diabetic individuals showed disappointing results (Davies *et al.*, 2000). Ojewole (2004) presented evidence that *Sutherlandia* extracts can reduce glucose uptake in STZ-treated mice. Chadwick *et al.* (2007) showed statistically significant increases in glucose uptake and no weight gain in pre-diabetic rats receiving *Sutherlandia* via their drinking water.

2.4.4 Inflammation, pain and wounds

Recent studies have indicated that *Sutherlandia* extracts have anti-inflammatory, analgesic and antibacterial activity. Kundu *et al.*, (2005) demonstrated *in vivo* inhibition of the expression of cyclooxygenase-2 (COX-2). Tai *et al.*, (2004) did not see significant antioxidant effects but Ojewole (2004) recorded statistically significant anti-inflammatory effects in reducing fresh egg albumin-induced pedal oedema in mice. There is a link between antioxidant and anti-inflammatory activities as demonstrated by Fernandes *et al.*, (2004), where a hot water *Sutherlandia* extract had superoxide and hydrogen peroxide scavenging activities at concentrations as low as 10 µg/ml. Katerere and Eloff (2005) were the first to report antibacterial activity (of hexane extract) against *S.aureus*, *S.faecalis* and *E.coli* at MIC values of 0.31, 1.25 and 2.50 mg/ml, respectively. The earliest recorded uses of *Sutherlandia* refer to the treatment of eye ailments.

2.4.5 Stress

The Zulu name *insiswa* (“the one which dispels darkness”) and the Tswana name *phetola* (“it changes”) both allude to the reversal of stress-related conditions. Sia, (2004) and Tai *et al.*, (2004) suggested that GABA may play a role in the improvement of mood of patients with chronic ailments. Prevoo *et al.* (2008) showed that *Sutherlandia* attenuates adrenal P450 enzymes, which may indicate a possible mechanism by which glucocorticoid levels (and symptoms of stress) are reduced.

2.4.6 Other indications

Ojewole (2008) studied an as yet unrecorded and unpublished traditional use for *Sutherlandia*, namely the treatment of childhood seizures and epilepsy. *In vivo* studies indicated that *Sutherlandia frutescens* aqueous leaf extracts displayed antithrombotic activity, with an IC50 value of 2.17 mg/ml.

2.4.7 Toxicology

Sutherlandia has a long history of traditional use, with no reports of any serious side effects, suggesting that it can be considered as generally safe. Mills *et al.*, (2005) recorded side effects as dryness of mouth, occasional mild diarrhoea or mild diuresis and dizziness in cachectic patients. Infusions or decoctions of 2.5 to 5 g of dry material per day can be regarded as the traditional dose (Van Wyk *et al.*, 1997). For commercial preparations, 300mg of dried leaves twice daily (i.e. 600mg per day) is recommended (with the usual precaution that it should be avoided during pregnancy or lactation). A

phase 1 clinical study of 25 healthy adults at Karl Bremer Hospital, Bellville, South Africa (Johnson *et al.*, 2007) has shown that two 400mg leaf powder capsules (800mg per day) was well tolerated, with no side effects noted during or after the three months trial period. There was no change in frequency of adverse events, nor any clinically significant changes in most physical, vital, blood and biomarker indices. It is possible that products, containing *Sutherlandia*, may interact with antiretroviral medication (Mills *et al.*, 2005) or with insulin or other diabetes medication (Sia, 2004).

2.5 Chemistry

It is known that *Sutherlandia frutescens* contains canavanine, GABA, Pinitol, flavanoids and saponins, which may be responsible for some of the plants activity.

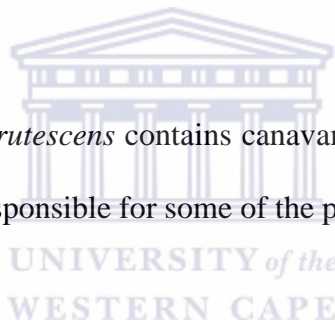

2.5.1 Free amino acids

In common with many members of the family *Fabaceae*, the leaves of *Sutherlandia* contain high levels of free and protein-bound amino acids, (Moshe, 1998; Van Wyk *et al.*, 2000) making it a valuable and palatable fodder plant. The commercial *Sutherlandia* (the so-called Phyto Nova™ Su-1 type) showed high levels of the free amino acids asparagines (1.6-35.0 mg/g), proline (0.7-7.5 mg/g) and arginine (0.5-6.7 mg/g). The presence of L-arginine is particularly interesting as this compound is an antagonist of L-canavanine that attenuates its anti-proliferative activity (Van Wyk and Albrecht, 2007).

2.5.2 Non-protein amino acids

Non-protein amino acids are commonly found in the seeds of *Fabaceae*. One of the most common compounds is L-canavanine, a seed metabolite recorded from many members of the legume family (e.g. Lucerne or alfalfa, *Medicago sativa* L.). The discovery of high levels of canavanine in *Sutherlandia* leaves by Moshe (1998) was therefore of considerable interest (Van Wyk *et al.*, 1997), and not only gave some explanation for the traditional use of *Sutherlandia* against cancer, but it also appeared to be the first known case of a canavanine-containing plant having a well-recorded history of use against cancer. The level of canavanine in leaves from different species and populations of *Sutherlandia* was found to be very varied, from 0.42mg per g to 14.5mg per g (Moshe, 1998) and about 1.3-3.1 mg/g in commercial *Sutherlandia* (SU-1type). Analysis of the same type of *Sutherlandia* by Tai *et al.*, (2004) confirmed the presence of canavanine in commercial material and recorded a level of 3 mg/g dry weight.

Canavanine has documented anticancer (Crooks and Rosenthal, 1994; Swaffar, 1995; Rosenthal, 1997; Bence *et al.*, 2002) and antiviral activity, including inhibition of influenza virus and retroviruses (Green, 1988).

2.5.3 GABA

The presence of γ -aminonutyric acid (GABA) may also be relevant, as commercial samples contain 0.23-0.85 mg/g (Van Wyk *et al.*, 2007). GABA is an inhibitory neurotransmitter that could partly account for the use of *Sutherlandia* to treat anxiety and stress. It has also been found to inhibit tumour cell migration (Ortega, 2003).

2.5.4 Pinitol

Early studies by Snyder (1965), Viljoen (1969) and Brümmerhof (1969) showed the presence of the cyclitol called ino-inicytol (also commonly known as pinitol) in *Sutherlandia microphylla* leaves. Using pure pinitol as a reference standard in HPLC analysis, with a refractive index detector, Moshe (1998) reported a level of up to 14mg/g dry weight in the leaves. The recorded bioactivities of pinitol make it a potentially important compound in the context of the traditional uses of *Sutherlandia* against diabetes and inflammation. Pinitol is a known anti-diabetic agent that may have an application in treating wasting in cancer and AIDS (Ostlund and Sherman, 1996). It exerts an insulin-like effect, resulting in lower blood sugar levels and increased availability of glucose for cell metabolism (Bates *et al.*, 2000) and augments the retention of creatinine by muscle cells (Greenwood *et al.*, 2001). Pinitol therefore seems to play a role in regulating cellular energy, resulting in increased energy levels, and a reduction in fatigue.

2.5.5 Flavanoids

Sutherlandia leaves are known to contain at least six flavanoids (Moshe, 1998; Fu *et al.*, 2009). Preliminary structural elucidation has indicated that these are flavonol glycosides (Van Wyk *et al.*, 2007).

2.5.6 Saponins

Saponins are the glycosides of 27 carbon atom steroids, or 30 carbon atom triterpenes. They are found in various parts of the plant: leaves, stems, roots, bulbs, blossom and fruit. Saponins dissolve in water to form a stable soapy froth due to its amphiphilic nature, hence the name *sapon*, which means “soap”. They are also characterized by their bitter taste and its ability to haemolyse red blood cells. The removal of the sugar moiety (hexoses, pentoses and saccharic acids) from a saponin by complete hydrolysis yields the aglycone, sapogenin. Saponins are highly toxic to cold-blooded animals, due to their ability to lower surface tension. Saponins as the sapogenin aglycone have also been identified in the animal kingdom in snake venom, starfish and sea cucumber (Sahelian, 2007; Dharmananda, 2000).

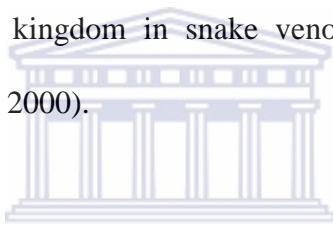

Triterpenes belong to a large group of compounds arranged in four or five ring configurations of 30 carbons with several oxygen's attached. Triterpenes are assembled from a C5 isoprene unit through the cytosolic mevalonate pathway to make a C30 compound that is steroidal in nature. Cholesterol is one example of a triterpene as well as phytosterols and phytoecdysteroids. Triterpenes are responsible for the adaptogenic effect found in plants such as *Panax ginseng* or *Eleutherococcus senticosus*. Most triterpenoid compounds in adaptogenic plants are found as saponin glycosides, which refer to the attachment of various sugar molecules to the triterpene unit. The sugars can be easily cleaved off in the gut by bacteria, allowing the aglycone (triterpene) to be absorbed, that allow them insert into cell membranes and modify the composition, membrane fluidity and potentially affect signalling by many ligands and cofactors

(Klein, 2004; Attele *et al.*, 1999; Lee *et al.*, 2003). Triterpenoid saponins are mild detergents and used to permeabilize the plasma membrane, as well as the membranes of internal organelles such as ER and Golgi, but do not penetrate the nuclear membrane. Therefore, it is used in intracellular histochemistry staining to allow antibody access to intracellular proteins. Saponins have hypercholesterolaemia, hyperglycaemia, antioxidant, anti-cancer, anti-inflammatory and weight loss activity (Sahelian, 2007; Desert King Chile, 2007).

Triterpene saponins are designated as such by the suffix ending-side, such as ginsenoside, astragaloside, named for the plant genera they were first discovered in. Diosgenin, a steroid sapogenin is a product of hydrolysis by acids, strong bases or enzymes of saponins, extracted from the tubers of *Dioscorea wild yam*. The sugar-free, aglycone, diosgenin is used for the commercial synthesis of progesterone, cortisone and other steroid products where as the unmodified steroid has estrogenic activity and can reduce the level of serum cholesterol. The steroid-like saponins in Wild yam can be chemically converted to progesterone contraceptives and cortisone. Ginsenosides are a class of steroid-like triterpene saponins, found exclusively in the plant genus *Panax* (ginseng). Ginsenosides are viewed as the active compounds behind the claims of ginseng's efficacy (Sahelian, 2007; Desert King Chile, 2007).

Triterpene glycosides were first detected in *Sutherlandia microphylla* leaves by Brümmerhof (1969) and Viljoen (1969), but the chemical structures were not determined.

Gabrielse (1996) isolated a pure compound (later called SU1) from extracts of *Sutherlandia frutescens* (*S. microphylla*). Moshe (1998) reported a complex pattern of triterpenes in the various species and forms of *Sutherlandia*, with limited variation within populations, but large differences between populations. Phytochemical investigation of *S. frutescens* led to the identification of one secocyclo-artanol glycoside (sutherlandiosides A) and three cycloartanol glycosides (sutherlandioside B, C and D), but the effect of these saponins is still unknown (Fu *et al.*, 2008). Sutherlandioside B, C and D are the first examples of naturally occurring cycloartanes with a C-1 ketene function. The major triterpene in commercial *Sutherlandia* material is a cycloartane-type triterpene glycoside called SU1 or sutherlandioside B (Fu *et al.*, 2008).

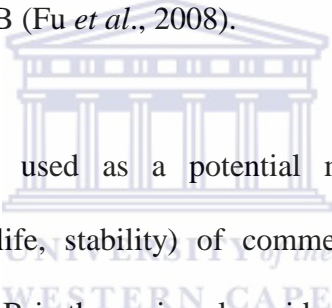

Sutherlandioside B could be used as a potential marker for the evaluation of pharmaceutical quality (shelf-life, stability) of commercially available *S. frutescens* preparation. Sutherlandioside B is the major glycoside and most abundant in the plant and was obtained as colourless needles from methanol in a yield of 1.95% (Fu *et al.*, 2007). Sutherlandioside B (SU1) is a cycloartane-type triterpene glycoside with a molecular formula as $C_{36}H_{60}O_{10}$ and the structure is defined as $3\alpha,7\beta,24S,25$ -tetrahydroxycycloartan-1-one 25-O- β -D-glucopyranoside (Fu *et al.*, 2007). At least 56 different triterpene glycosides have been detected in various provenances of *Sutherlandia*. The mixture of cycloartane-type triterpenoid glycosides also varies geographically in South Africa (Olivier *et al.*, 2008 C. Albrecht, 2008). The chemical structure of the major cycloartane glycoside, sutherlandioside B can be seen in figure one.

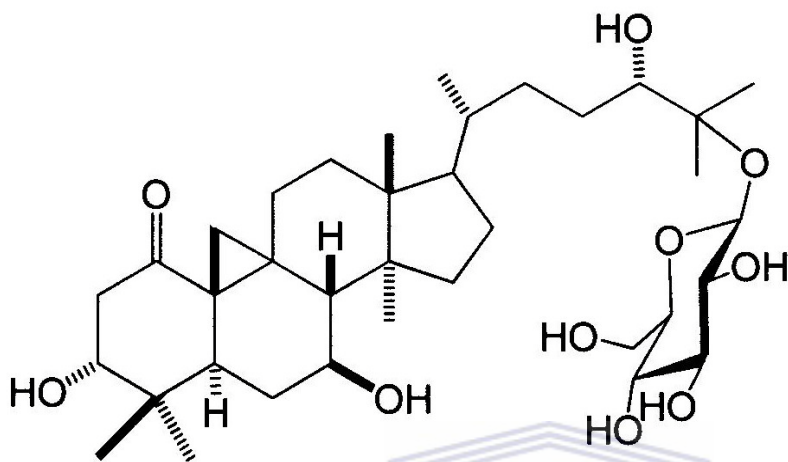

Figure 1: Chemical structure of sutherlandioside B

Sutherlandioside B proves to be a possible marker for the determination of the pharmaceutical quality of *Sutherlandia* product. However, a suitable analytical method for the determination of SU-B levels in these products is required.

2.6 Analytical methods suitable for sutherlandioside analysis

Saponins are very challenging to analyze because of their reactivity. However, various solvents, such as alcohols (i.e. methanol) and organic solvents such as chloroform or hexane, are commonly used to extract the aglycone form of saponins.

The complete analysis of the absolute structure and configuration of saponins is usually a complicated task, which requires the application of advanced techniques such as Nuclear

magnetic Resonance (NMR) spectroscopy, X-ray diffraction, optical rotary dispersion and mass spectrophotometry. Since only a few laboratories are equipped and staffed to make all these expensive methods available, simpler approaches to saponins characterization are often desired. Therefore, modern chromatographic techniques such as Thin Layer Chromatography and High Performance Liquid chromatography (HPLC) are often used. Some of these techniques are normally coupled with different detectors including the fluorescens, UVspectro-photometry (i.e. most commonly use), photo diode array and evaporative light scattering (ELSD) (Havsteen, 2002; Hollman and Katan, 1999).

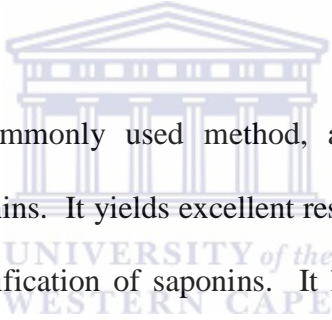

The HPLC is the mostly commonly used method, and has become the standard equipment for analysis of saponins. It yields excellent resolution and retention times that are extremely reliable in identification of saponins. It has several advantages such as simplicity, sensitivity, specificity and better separation when using smaller sample quantities. More specifically Reverse-Phase HPLC is the most commonly used form of HPLC.

In reverse phase HPLC, the column size is the same, but the silica is modified to make it non-polar by attaching long hydrocarbon chains to its surface - typically with either 8 or 18 carbon atoms in them. A polar solvent is used - for example, a mixture of water and an alcohol such as methanol. There will be a strong attraction between the polar solvent and polar molecules in the mixture being passed through the column. There will not be as much attraction between the hydrocarbon chains attached to the silica (the stationary

phase) and the polar molecules in the solution. Polar molecules in the mixture will therefore spend most of their time moving with the solvent. However, the non-polar compounds in the mixture will tend to form attractions with the hydrocarbon groups because of Van der Waals dispersion forces. They will also be less soluble in the solvent, because of the need to break hydrogen bonds. They therefore spend less time in solution in the solvent and this will slow them down on their way through the column. The addition of pH modifiers such as acetic acid or formic acid are normally used to reduce the presence of the ionized form, thus improving the retention time (Muganga, 2004). Therefore, the availability and sensitivity of these analytical methods provide the possibility of developing a stability-indicating HPLC assay. Figure two presents a flow schematic representation of a HPLC system starting from sample injection through to the processing and the display of the signal.

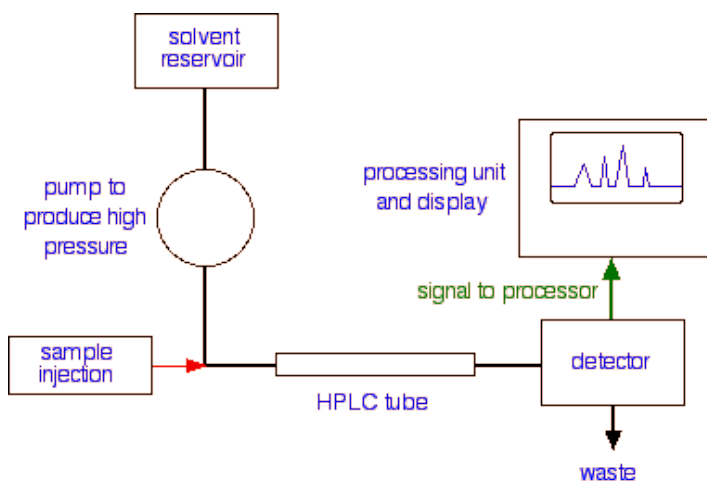
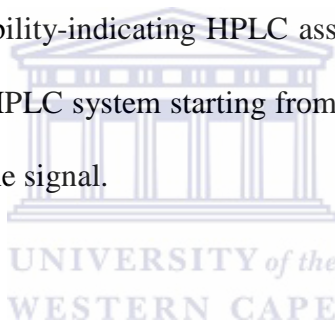
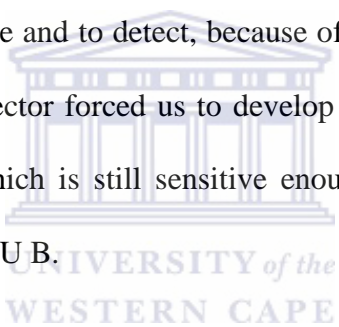

Figure 2: A flow scheme for HPLC

During the HPLC method development, it was noted that, for the determination of saponins and triterpenoids, a reverse phase HPLC method, with an evaporative light scattering detector (ELSD), is usually employed, because the ELSD response does not depend on the samples optical characteristics and is capable of detecting most non-volatile compounds (Vervoort *et al.*, 2008). As a result, it has been successfully applied to the analysis of these compounds such as sugars, saponins (Wei *et al.*, 2007; Wang *et al.*, 2007), fatty acid esters and steroidal alkaloids. A C18 column is usually employed as stationary phase with a mobile phase of acetonitrile- aqueous phase, with a 0.1% acetic acid or formic acid as buffer. The sutherlandiosides are structurally very closely related and very challenging to separate and to detect, because of their low UV absorption. The unavailability of an ELSD detector forced us to develop a HPLC assay, coupled with a UV diode array detector, which is still sensitive enough to detect low levels of the major cyclo-artane glycoside, SU B.



2.7 Validation of analytical procedures in this case, a stability-indicating HPLC method

Method validation is regarded as the process of providing documented evidence that the method does what it is intended to do. Method validation provides an assurance of reliability during normal use. The validation of analytical procedures is directed to the four most common types of analytical procedures, viz. the identification test, quantitative test for impurities, limit tests for the control of impurities and the quantitative tests of the active moiety in samples of drug substance or drug product or other selected component(s) in the drug product. Identification tests are intended to ensure the identity

of an analyte in a sample. This is normally achieved by comparison of a property of the sample (e.g. spectrum, chromatographic behaviour, chemical reactivity, etc) to that of a reference standard. Testing for impurities can be either a quantitative test or a limit test for the impurity in a sample. Either test is intended to accurately reflect the purity characteristics of the sample. Different validation characteristics are required for a quantitative test than for a limit test. Assay procedures are intended to measure the analyte present in a given sample. Typical validation characteristics which should be considered are; accuracy, precision, repeatability, intermediate precision, specificity, detection limit, linearity and range. The quality of analytical data is a key factor in the success of a drug development program, thus the process of method development and validation has a direct impact on the quality of these data.

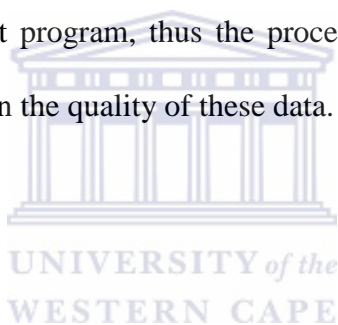

2.7.1 Specificity

Specificity is the ability to assess unequivocally the analyte in the presence of components (including impurities, degradants and matrix) which may be expected to be present. It is a measure of the degree of interference from such things as other active ingredients, excipients, impurities and degradation products, ensuring that a peak response is due to a single component only (i.e. that no co-elutions exist). An investigation of specificity should be conducted during the validation of identification tests and the determination of impurities and the assay (content or potency). For identification purposes, specificity is demonstrated by the ability to discriminate between compounds of closely related structures, or by comparison to known reference materials

and for assay and impurity tests, it is demonstrated by the resolution of the two closest eluting compounds. These compounds are usually the major component or active ingredient and an impurity.

2.7.2 Accuracy

The accuracy of an analytical procedure expresses the closeness of agreement between the value, which is accepted either as a conventional true value or an accepted reference value and the value found. Accuracy is also termed trueness. The accuracy can be established by the application of an analytical procedure to an analyte of known purity (e.g. reference material), by comparing the results of the proposed analytical procedure with those of a second well-characterized procedure, the accuracy of which is stated or defined and can be inferred once precision, linearity and specificity have been established. It should be assessed by using a minimum of 9 determinations over a minimum of 3 concentration levels covering the specified range (e.g. 3 concentrations/ 3 replicates each of the total analytical procedure). Accuracy should be reported by the assay of known added amount of analyte in the sample or as the difference between the mean and the accepted true value together with the confidence intervals.

2.7.3 Repeatability

Repeatability expresses the precision under the same operating conditions over a short interval of time. Repeatability is also termed intra-assay precision and should be assessed using a minimum of 9 determinations covering the specified range for the procedures (3 concentrations/ 3 replicated each).

2.7.4 Precision

Precision measures the degree of repeatability of an analytical method under normal operation and is normally expressed as the %RSD for a statistically significant number of samples. According to the ICH, precision should be performed at three different levels: repeatability, intermediate precision and reproducibility. Reproducibility refers to the results of collaborative studies between laboratories. Documentation in support of precision studies should include the standard deviation, relative standard deviation, coefficient of variation and the confidence interval.

2.7.5 Reproducibility



Reproducibility expresses the precision within-laboratories variations: different days, different analyst and different equipment.

2.7.6 Limit of detection (LOD)

The detection limit of an individual analytical procedure is the lowest amount of analyte in a sample which can be detected, but not necessarily quantitated as an exact value. It is expressed as a concentration at a specified signal-to-noise ratio, usually two-or three-to-one. The ICH has recognized the signal-to-noise ratio convention, but also listed two other options to determine LOD: visual non-instrumental methods and a means of calculating the LOD. Visual non-instrumental methods may include LOD determination by thin layer chromatography (TLC) or titrations. Calculations based on the standard

deviation of the response (SD) and the slope of the calibration curve (S) at levels approximating the LOD according to the formula: $LOD = 3.3(SD/S)$. The method used to determine LOD should be documented and supported and an appropriate number of samples should be analyzed at the limit to validate the level.

2.7.7 Limit of quantisation (LOQ)

Is the lowest concentration of an analyte in a sample that can be determined with acceptable precision and accuracy under the stated operational conditions of the method. LOQ is expressed as a concentration, with the precision and accuracy of the measurement also reported. A signal-to-noise ratio of ten-to-one is recognized by the ICH as typical. The determination of LOQ is a compromise between the concentration and the required precision and accuracy. As the LOQ concentration level decreases, the precision increases. If better precision is required, a higher concentration must be reported for LOQ. This compromise is dictated by the analytical method and its intended use. The same two addition as for LOD can be used to determine LOQ, visual non-instrumental methods and a means of calculating the LOQ. $LOQ = 10 (SD/S)$.

2.7.8 Linearity and range

Linearity is the ability of the method to elicit test results that are directly proportional to analyte concentration within a given range. It is reported as the variance of the slope of

the regression line and is the interval between the upper and lower levels of analyte (inclusive) that has been demonstrated to be determined with precision and accuracy. The ICH guidelines specify a minimum of five concentration levels, along with certain minimum specified ranges. For assay, the minimum specified range is from 80-120% of the target concentration.

2.7.9 Ruggedness

Is the degree of reproducibility of the results obtained under a variety of conditions (including different laboratories, analyst, instruments, reagents, days) expressed as %RSD. In the guidelines on definitions and terminology, the ICH did not address ruggedness specifically. This apparent omission is really a matter of semantics, however, ICH chose instead to cover the topic of ruggedness as part of precision.

2.7.10 Robustness

Is the capacity of a method to remain unaffected by small deliberate variations in method parameters, such as small changes in organic solvent composition, pH, ionic strength, temperature, etc., and determining the effect (if any) on the results of the method. As per ICH guidelines, robustness should be considered early in method development. If the

results are susceptible to variations in method parameters, these parameters should be adequately controlled.

2.7.11 System suitability

According to the USP, system suitability tests are an integral part of chromatographic methods. These tests are used to verify that the resolution and reproducibility of the system are adequate for the analysis to be performed. System suitability tests are based on the concept that the equipment, electronics, analytical operations and samples constitute an integral system that can be evaluated as a whole. System suitability is the checking of a system to ensure system performance before or during the analysis of unknowns. Parameters such as plate count, tailing factors, resolution and reproducibility are determined and compared against the specifications for the method. These parameters are measured during the analysis of a system suitability “sample” that is a mixture of main components and expected by-products.

The developed HPLC assay was applied to determine the SU-B levels in two commercially available products, viz Phyto Nova Sutherlandia SU1™ tablets and the Promune™ capsules.

2.8 Commercially available *Sutherlandia* products

Several *Sutherlandia* preparations, made from different raw plant material, mostly the dried leaf powder (i.e. leaves and thin stems) are now commercially available in South Africa. The Phyto Nova team was the first to make *Sutherlandia* tablets commercially available, by initiating large-scale cultivation and contract manufacturing. The Phyto Nova *Sutherlandia* SU1™ tablets are marketed as a special chemotype that are made from a superior *Sutherlandia frutescens* variety. SU1 – a novel plant chemical had been isolated and characterized by Phyto Nova and used to breed a specific variety of *Sutherlandia* for large scale farming, a process that has not involved cloning or genetic modification. *Sutherlandia* plants of the same species may appear identical externally, but have major variations in chemical constituents due to genetic, climatic, altitudinal and soil factors. Phyto Nova *Sutherlandia* SU1™ is the only *Sutherlandia* that has been studied for safety by the Medical Research Council of South Africa in an independent safety evaluation in 2002 and the results confirmed the safety of Phyto Nova's *Sutherlandia* SU1™, including haematology, hepatic and renal functions. The Phyto Nova *Sutherlandia* SU1™ was chosen upon, because it's the market leader of the dried leaf powder solid dosage forms and to test if all the claims made can be justified.

Recently, a preparation, viz Promune™, containing the freeze dried aqueous extract of *Sutherlandia*, became commercially available in capsule form. Promune™ capsules are manufactured locally by a company called Ferlot Manufacturing and Packaging (PTY) Ltd. in Jeffrey's Bay, South Africa. Promune™ are presented as a size 2 hard gelatine capsule with a dark green cap and a white body containing a grey-white powder with a

characteristic taste, with no imprinting on the capsule. The manufacturer claimed that their product is ‘better’ than the dried leaf powder solid dosage forms as it mimics the traditional dosage form (herbal tea). However, it is not really clear how these two products compare, in terms of chemical composition, efficacy and *in vivo* bioavailability of its active constituents. Figure three presents the two commercially available *Sutherlandia* products of interest viz Phyto Nova Sutherlandia SU1™ and Promune™.



Figure3: Commercially available *Sutherlandia* products viz Phyto Nova Sutherlandia SU1™ and

Promune™

2.9 Effect of elevated temperature and humidity

Stability testing is the primary tool to assess expiration dating and storage conditions for pharmaceutical products. Many protocols have been used for stability testing, but most in the industry are now standardizing on the recommendation of the International Conference for Harmonization (ICH). Stability testing includes long-term studies, where the product is stored at room temperature and humidity conditions, as well as accelerated studies, where the product is stored under conditions of high heat and humidity. Stability studies are linked to the establishment and assurance of safety, quality and efficacy of the drug product from early phase development through the lifecycle of the drug product. Stability data for the drug substance are used to determine optimal storage and packaging conditions for bulk lots of the material, as well as to determine the expiration date (or shelf life). In order to assess stability, the appropriate physical, chemical, biological and microbiological testing must be performed.

In accelerated environmental conditions, the intrinsic stability and degradation profile of the drug substance is evaluated. HPLC is the predominant tool used to analyze the drug substance and the impurities. The same HPLC method may be used for drug substance and drug product, although different sample preparation methods would normally be required. Stress studies at elevated temperature (e.g. 50°C, 60°C and 70°C) for several weeks may be performed to assess thermal stability. Provided the degradation mechanism is the same at the different temperature used, kinetic or statistical models can be used to determine the rate of degradation at other temperatures (e.g. 25°C). The solid stability should also be performed in the presence and absence of water vapour to assess

the dependence of stability on humidity. Degradation studies should also be performed in solutions with pH range 2-9 to assess the impact of solution pH on degradation. Photo-stability should also be evaluated. Oxidation of drug substance under accelerated conditions (e.g. hydrogen peroxide) may also be performed to establish oxidation products that could be formed and sensitivity to oxidative attack. According to ICH guidance for design of clinical stability studies, the selection of batches, the container closure system, specifications, testing frequency and storage conditions, are the most important factors to consider. The container closure system must be evaluated for compatibility with the drug substance and drug product to ensure that the container does not contribute to degradation or contamination. The testing frequency represents the minimum data required for filing. It may be advisable to pull and test a one-month sample for each storage condition to ensure that the study is proceeding as expected. Stability studies are very much interwoven through the entire fabric of the drug product life cycle, therefore a detailed knowledge of the stability requirements and the impact on other areas (e.g. container closure, process changes) is needed to properly design and evaluate stability studies (Microbac Laboratories 2005; ICH Guidelines, 1994; www.fda.gov/cder/guidance/cmc3.pdf)

2.10 Acid- hydrolysis

Hydrolysis is a chemical reaction during which one or more water molecules are split into hydrogen (H^+) and hydroxide ions (OH^-) in the process of a chemical mechanism. The addition of an acid serves as a catalyst for the degradation process. The hydrolysis of saponins by a strong acid yields the aglycone form of the saponins. The breakdown of the saponins may indicate the pharmaceutical stability in the GIT (gastric acid) ,and hence the effect of acid hydrolysis on the levels of SU-B in the two commercial *Sutherlandia* is also determined (www.fda.gov/cder/guidance/cmc3.pdf).





UNIVERSITY *of the*
WESTERN CAPE

CHAPTER THREE

PLAN OF WORK

3.1 Introduction

This chapter describes the objectives, hypothesis and study approach proposed for the study.

3.2 Objectives

The objectives of this study were:

1. to develop a validated stability-indicating HPLC assay for the determination of sutherlandioside B present in *Sutherlandia* plant materials,
2. to identify and quantify the levels of sutherlandioside B present in a commercially available capsule form containing the freeze-dried aqueous extract of the plant (Promune™) and one containing the dried leaf powder (Phyto Nova Sutherlandia™) and
3. To determine the effect of elevated temperature and environmental, as well as acid hydrolysis, on the stability of the two commercially available products, and to determine their pharmaceutical product quality by assessing their levels of sutherlandioside B.

3.3 Hypothesis

It was hypothesized that:

1. Sutherlandioside B, based on HPLC peak area (i.e. SUB peak area $> \sum$ rest of cycloartanol glycoside peak areas) would be the most dominant cyclo-artanol glycoside present in these products,
2. The Phyto Nova Sutherlandia™ product would have higher levels of sutherlandioside B than that in the Promune™ capsules. (i.e. Phyto Nova Sutherlandia SU-B concentration $>$ Promune SU-B concentration) and
3. Elevated environmental temperature and humidity and acid hydrolysis would produce a greater decrease in the levels of sutherlandioside B in the dried powder tablet product than the aqueous extract containing capsule form(i.e. Promune™ t_{90} elevated conditions $>$ Phyto Nova Sutherlandia™ t_{90} elevated conditions).



3.4 Study approach

The above objectives and hypotheses were realized using the following approach:

3.4.1 Selection of *Sutherlandia* products to test

Firstly, several *Sutherlandia* preparations, made from different plant raw material, are commercially available in South Africa. These commercially available preparations are found in various dosage forms including tablets, capsules, traditional tea, gels and aqueous infusions and decoction. Overall, the pharmaceutical quality of all the various *Sutherlandia* dosage forms, including oral solid dosage forms, have however, not yet been investigated and consequently, the latter was focussed on in this study. Secondly, *Sutherlandia frutescens* is currently extensively being researched at the South African

Herbal Science and Medicine Institute (SAHSMI), University of the Western Cape (ref??) The focus of this research includes the clinical evaluation of *S. frutescens*, the identification of markers that can be used for quality and efficacy assessments and the development of criteria for the evaluation of quality and stability of *Sutherlandia* herbal products. The program also aims to provide specification guidelines that the South African regulatory authority *viz* the Medicines Control Council (MCC) could use for the registration of commercially available *Sutherlandia* products. Phyto Nova *Sutherlandia* SU1™ and Promune™ are two such products that may need to be registered. The Phyto Nova *Sutherlandia* SU1™ tablets and Promune™ capsules are both market leaders and widely available in South Africa. The former is an example of the dried leaf powder dosage forms, which is most widely found in the market, while the other is a freeze-dried aqueous extract containing preparation, which more closely resembles the traditionally used decoction form. The results of this study would thus be reflective of the whole range of presently available commercial solid oral dosage forms.

3.4.2 Selection of Sutherlandioside B as stability-indicating marker compound

The major triterpene in commercial *Sutherlandia* material is a cycloartane-type triterpene glycoside called SU1 or Sutherlandioside B. Sutherlandioside B may be responsible for the plant's anti-cancer activity (Crooks and Rosenthal, 1994; Swaffar, 1995; Rosenthal, 1997; Bence *et al.*, 2002). For example the most powerful inhibitory effects in an *in vivo* mouse skin carcinogenesis were found in cycloartanes with hydroxylation at C-24 and with a 3-oxo group and this configuration are present in sutherlandioside B. Sutherlandioside B also seems to be easily extractable from plant material, stable in the

various plant samples under various processing conditions, and can easily be assayed using a simple extraction and HPLC analytical procedure. Consequently it was selected as the stability-indicating marker compound to be used in this study.

3.4.3 Development and validation of a HPLC assay for Sutherlandioside B.

The objectives of this study necessitated the quantification of very low concentrations of sutherlandioside B in the plant material, thus an HPLC method offered a viable solution. Indeed in recent times, HPLC has become the standard method for the analysis of triterpenoid glycosides. It yields excellent resolution and reproducible retention times of the glycosides that are structurally quite similar (Fu *et al.*, 2000). It is also a simple analytical technique that is quite specific, sensitive and reproducible in compound separation when using small sample quantities and can be used with a variety of detection methods. For this study, UV detection was considered because it is readily available, cost efficient and amendable for routine quality control use. HPLC in combination with mass spectrometry (MS) can even be used for biological sample analysis and identification of breakdown products. All these attributes suggested that HPLC could be effectively applied for the present investigation.

3.4.4 Determination of the effect of elevated environmental temperature and humidity and acid hydrolysis on the Sutherlandioside B levels in Phyto Nova Sutherlandia SU1™ tablets and Promune™ capsules

Stability testing is the primary tool used to establish expiry dates and storage conditions for pharmaceutical products. Generally, stability studies are linked to the establishment and assurance of safety, quality and efficacy of the drug. There appeared to be no product stability data available to ascertain whether the expiry dates (shelf life) assigned for the Phyto Nova Sutherlandia™ tablets and Promune™ capsules were accurate and, therefore, the absolute quality of these medicines was unknown. Normally, the shelf life is determined by testing the pharmaceutical stability at ambient conditions over a long period (± 2 years) or under stress conditions, such as like elevated environmental temperature and humidity over shorter periods (weeks or months). Because of the limited time available and as this is the first investigation on these Sutherlandia products, stress testing at elevated environmental temperature (e.g. 40°C) and humidity (e.g. 75% RH) for several weeks were performed and the levels of sutherlandioside B monitored as chemical marker, to ascertain and compare the physiochemical stability of the Phyto Nova Sutherlandia SU1™ tablets and Promune™ capsules. The products were also subjected to acid hydrolysis to determine the stability of SU-B in an acidic environment and to mimic the effect that low pH in the GIT might have on the products... It was expected that the results of the above investigations would provide most valuable information on the relative pharmaceutical qualities of the two dosage forms.

CHAPTER FOUR

MATERIALS AND METHODS

4.1 Introduction

This chapter reports the chemicals and reagents, equipment and instruments, methods and procedures used during the extraction, isolation and preparation of the plant material, the identification of the sutherlandioside B (by TLC, HPLC and LC-MS), the HPLC assay and, finally, the stability studies.

4.2 Chemicals and reagents

The following chemicals and reagents were used in the preparation and assay of the plant materials and the isolation of the sutherlandioside B.

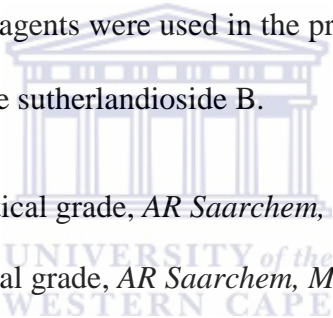
- 
- Methanol (analytical grade, *AR Saarchem, Merck Chemicals, PTY Ltd*)
 - Hexane (analytical grade, *AR Saarchem, Merck Chemicals, PTY Ltd*)
 - chloroform (analytical grade, *AR Saarchem, Merck Chemicals, PTY Ltd*)
 - n-butanol (analytical grade, *AR Saarchem, Merck Chemicals, PTY Ltd*)
 - acetonitrile (HPLC grade, *Burdick and Jackson®*, USA)
 - helium gas and nitrogen gas (*Afrox Ltd Epping, South Africa*)
 - formic acid 99% (analytical grade, *KIMIX Chemicals & laboratory suppliers, USA*)
 - silica gel for column chromatography (40 μ m, *J.T. Baker*)
 - TLC silica gel sheets (Alugram Sil G/UV₂₅, *Marcherey-Nagel, Germany*)
 - vanillin spray
 - distilled water (prepared using a Purite select Analyst HP water purification system, *England*)

- The Phyto Nova Sutherlandia SU1™ tablets (containing 300mg of Sutherlandia frutescens dried leaf powder)
- Promune™ capsules (containing 90mg Sutherlandia frutescens freeze-dried aqueous extract) were purchased from a local health store in Cape Town (2009)

4.3 Equipment and instruments

The following equipment and instruments were used.

High Performance Liquid Chromatography (HPLC) System- An Agilent HPLC system 1200 series (Hewlett Packard®) consisting of a G1311A Quaternary Pump, a G1322A Degasser, a G1315B Diode-array detector and a G1329A Auto Sampler was employed. All the modules were controlled by the Agilent Chemstation software. The column used in this system was the Discovery® HS C18 reverse phase column (USA) having 5µm particle size and a column length of 150 mm. The column was equipped with a 2cm LC-18 guard column (Phenomenex, Torrance, CA, USA)

LC-MS System- A Waters API Q-TOF Ultima Instrument equipped with an ESI source and an Agilent LC system 1100 series with the following modular components: a HP-1100 quaternary pump, a vacuum solvent micro degasser, auto sampler and the HP ChemStation for LC 3D software were used.

Climatic Chamber- a Labcon Humidity Incubator (FSIE-RH20, Labmark®, Roodepoort, South Africa) was used and set at 40⁰C and 70% relative humidity (RH).

Other instruments- In addition to the above, the following instruments were also used:

- Filter unit (Millipore, Cameo 25 AS, DDA 02025So MSI: *Micro separation INC., USA*)
- centrifuge (*Labofuge 200, Germany*)
- vortex (Vortex-2G-560E, *Scientific Industries, Inc. Bohemia, N.Y 11716 USA*)
- micropipette 100µl and 1000µl (*Gilson Medical electronics (France). SA*)
- oven (*Memmert 854 Schwabach, Germany*)
- balance (*Wirsam Scientific & Precision Equipment (PTY) Ltd. Model GA 110, Germany*)
- hot plate (Type *Rct13 Kg D-79219, Kika-Werke GmbH&Co., Staufen Germany*)
- water bath (*Cph110, Lab design Engineering Pty Ltd, South Africa*)
- vacuum filtration system (*Supelco, South Africa*)
- vacuum pump (*Medi-pump Model 1132-2, Thomas Industries, Inc., USA*)

4.4 EXPERIMENTAL METHODS AND PROCEDURES

4.4.1 Collection and identification of *Sutherlandia frutescens* plant material

In this study, 3 types of *Sutherlandia* materials i.e. plant raw material and tablet and capsule dosage forms were analyzed for sutherlandioside B content and stability using a HPLC method. The *Sutherlandia frutescens* powdered plant material was obtained from Afriplex (PTY) Ltd., Paarl, South Africa in July 2007. The bulk of the dried leaf powder was manufactured into capsules that were used in a clinical study at Karl Bremer hospital, Cape Town (Johnson *et al.*, 2007). The dried leaf powder used in the present study was packed into aluminium containers, sealed and stored in a dark cupboard at room temperature until further use.

The Phyto Nova Sutherlandia SU1™ tablets and the Promune™ capsules were purchased at a local health shop in Paarl, South Africa in the summer of 2008. The products had an expiry date of 31st of December 2010 and were stored at 25°C in a dark cupboard until further use.

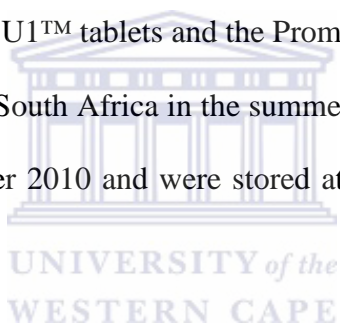

4.4.2 Extraction and isolation of sutherlandioside B

The method of Fu *et al.*, (2008) was used and adapted to isolate SU-B from *Sutherlandia frutescens* powdered plant material. Briefly, 100g of the dried powder was extracted with 600mL methanol for 3 consecutive days (600ml ×24hours ×3) at room temperature. The combined extracts were concentrated *in vacuo* (under 45⁰C) to obtain a dry extract. The latter was then suspended in 600ml of purified water and extracted with 400ml hexane followed by 300ml chloroform and finally with 300ml *n*-BuOH (saturated in H₂O)

sequentially. The *n*-BuOH phase was evaporated to dryness *in vacuo* and the residue subjected to silica gel chromatography using a stepwise gradient mixture of approximately 200ml of CHCl₃/MeOH/H₂O (v/v) in ratio 9:1:0, then 6:1:0 and finally 7:3:0.5 as eluent to give fractions. The flow rate was set at approximately 10ml per hour and fractions were collected every hour. The total duration of the column chromatography was 5 days. TLC was used to detect the presence of triterpenoids in the collected fractions. For the TLC, mobile phase, consisting of CHCl₃: MeOH, ratio 9:1 was used. The TLC plates were first viewed under UV at 254 nm and the spots marked and then sprayed with vanillin dye, followed by heating on a hot plate to visualize the spots. The column chromatography yielded 140 subfractions. Subfractions 51-59 were combined, evaporated to dryness under a gentle stream of nitrogen gas, reconstituted in 10ml of methanol and then the solution was subjected to semi-preparative TLC, which yielded crystals of the major glycoside, sutherlandioside B. The isolated sutherlandioside B was then subjected to TLC, LC-UV and LCMS analysis to verify its identity as described below.

4.4.3 Identification of sutherlandioside B by TLC, HPLC and LC-MS methods

First, TLC was performed on silica gel sheets (Alugram® Sil G/UV₂₅₄, *Macherey-Nagel, Germany*), for the qualitative determination of sutherlandioside B. For this, the SU-B fraction collected by semi-preparative TLC was reconstituted in a small volume of methanol and samples spotted on the plates developed, using mobile phase (CHCl₃: MeOH, ratio 9:1). The sutherlandioside spot on the plate was visualized by using vanillin

spray. For the latter, 6g of vanillin, was dissolved in 95mL of 96% ethanol, after which 1.5mL of concentrated sulphuric acid was carefully added to give a clear colourless solution. After elution the TLC plates were allowed to dry and were immediately viewed under UV to locate and mark the spots of the analyte. The plates were then sprayed with vanillin stain and heated on a hot plate until coloured spots appeared and the Rf value recorded.

Thereafter, qualitative techniques, such as HPLC and LC-MS, were further used for the identification of sutherlandioside B. For identification by HPLC, 10µl of the SU-B standard solutions were injected and separated on a Discovery® C-18 column using mobile phase 0.1 % formic acid/ acetonitrile (A) and 0.1% formic acid/ distilled H₂O (B). The column was set at 40⁰C and the mobile phase was pumped at 1ml/ min. A linear gradient was used, starting with 15% (A)/85% (B) to 65% (A)/35% (B) over 20 minutes followed by a 5 minute wash with 100% (A) and a 15 minute equilibrium period with 15% (A)/85% (B). Detection was made possible by employing a diode array (UV) detector, set at 260nm and the retention time, peak spectra and peak purity were recorded. To establish the retention time for the sutherlandioside B standard, 100µl aliquots of standard solutions were injected in triplicate 3 times onto the HPLC column. The retention time of the peak produced was noted and the average and standard deviation determined. To identify the SU B peak in the plant material, the retention times of the peaks obtained when plant material was subjected to analysis under similar HPLC conditions, (discussed earlier) were compared. The diode array detector was used to scan the UV spectra of the peak of interest in both the standard solution and that of the plant.

Furthermore, the plant samples were spiked with SU B to see changes in the height of the suspected peak.

Thereafter, LC-MS analysis was done to confirm the identity and purity of the isolated samples of the SU-B fraction collected. The method involved the use of the $[M+H]^+$ and $[M+Na]^+$ ions in the positive and negative ion mode with extractive ion monitoring (EIM) and by comparing the MS-data obtained against that reported by Fu *et al.*, (2008). The LC-MS analysis was performed on a Waters API Q-TOF Ultima Instrument, equipped with an ESI detector. All acquisitions were performed under positive and negative ionization mode with a capillary voltage of 3.5kV. Nitrogen was used as nebulizer gas, as well as the drying gas at 350L/h at a temperature of 350⁰ C. Full scan mass spectra were acquired from m/z 100- 1990. Data acquisition and processing were done using the Waters API Q-TOF software. One microliter of the sample (standard solution) was injected in the LC-MS system, using a Waters Xbridge C18, 2.1 ×50mm column. The mobile phase consisted of water (A) and acetonitrile (B) at a flow rate of 0.35ml/ min, with the following gradient elution: 0 - 0.5min 100% A/0% B, then to 0% A/ 100% B over 8 min. Each run was followed by an equilibration period of 7 min with 100% A/0 % B. The total run time for analysis was 15 minutes. Peak retention times and mass data were obtained from the total ion chromatograms and MS-MS fragmentation and analyzed to identify the compound(s) represented by the peaks.

4.4.4. HPLC assay for determination of sutherlandioside B levels in plant materials

An HPLC assay was developed and validated for the quantitative determination of sutherlandioside B in *Sutherlandia* samples.

4.4.4.1. Preparation of standard solutions

To validate the assay and finally to quantify the levels of SUB in the plant materials and products the following standard solutions were prepared. The individual stock solutions of standard compounds were prepared by dissolving appropriate amounts of the isolated SU-B (see 4.4.2 & 4.4.3) in absolute methanol to obtain final concentration of 330µg/ml. The stock solutions were stored, protected against light and refrigerated at -20°C, and only thawed just prior to use. Working solutions were prepared by further diluting the stock solution with methanol to produce standard solutions at 5 different concentration levels over the range of 22-330µg/ml.

4.4.4.2 General HPLC procedure

For the separation and quantification of sutherlandioside B, the Agilent HPLC system was used with a Discovery® HS C18 HPLC column (15cm× 4.6mm, catalog# 568522-U) kept at a constant temperature of 40°C. The mobile phase consisted of 0.1% formic acid-acetonitrile (A) and 0.1% formic acid-distilled water (B) and was pumped at a flow rate of 1mL/min. Separation was performed using the following linear gradient elution: 15%A/85%B to 65%A/35%B over 20 min. Each run included a 5 minutes wash

with 100% A and an equilibration period of 15 min with 15% A/85%B. The eluted peaks were detected at wavelengths of 260 and 349nm.

4.4.4.3 Validation of the HPLC assay

Before the HPLC assay was used, it was validated for separation and specificity, the inter- and intra-day variability, quantification and detection limits and linearity. The separation and specificity of the assay were assessed by determining the absence of peaks of endogenous compounds interfering with the SU-B peaks in the plant material. Accuracy of the method was confirmed by performing a recovery experiment. A sample of *Sutherlandia frutescens* was spiked with known amounts of the standard compound, the spiked sample extracted and the chromatograms obtained analyzed. To check for the intra- and inter-day reproducibility of the assay, five different concentrations of SU B were analyzed several times and on different days and the percentage coefficient of variation calculated for each individual concentration. The limit of detection (LOD) and limit of quantification (LOQ) were defined at signal-to-noise levels equal to 3 and 10, respectively. The LOD was taken to be the lowest sutherlandioside B concentration, which under the described HPLC conditions, produced a peak height at least three times higher than the base line noise. At least three replications were used for each concentration. Lastly, the linearity of the standard curve for SU B was assessed by comparing the peak area *versus* concentration of the standard solution of sutherlandioside B (prepared under 4.4.4.1), Graphpad Prism was used to construct the peak area *versus* concentration of SU-B calibration curve and for the linear regression analysis of the data

to give the slope, intercept and correlation coefficient data, which were used to calculate the SU-B concentration in each test sample.

4.4.4.4 Determination of SU-B levels in Sutherlandia plant raw material, Promune™ capsules and Phyto Nova Sutherlandia SU1™ tablets

To determine the levels of SU B in the test samples, dry plant sample (500 mg) and dietary supplements (equivalent to 0.2 and 0.5 g capsule content and tablet weight respectively) were added to 5mL of methanol in a 10ml test tube, the latter inverted 10 times, vortexed for 4 minutes, sonicated for 30 min under ambient temperature and then centrifuged for 15 min at 3500 rpm. Thereafter the supernatant was transferred to a 10 ml volumetric flask. Prior to injection, an adequate volume (ca. 2mL) was passed through a 0.45 µm nylon membrane filter, the first 1.0 ml discarded and the remaining volume collected in an HPLC sample vial. Each sample (dry plant material, Phyto Nova Sutherlandia SU1™ methanol solution and the Promune™ methanol solution) was injected in triplicate and the injection volume was 10 µl. The amount of SU-B in each sample was determined from the standard curve and 3 samples of the analyte (i.e. n=3) were assayed and the average amount of SU-B in the dry Sutherlandia leaf powder, Promune™ capsules and Phyto Nova Sutherlandia SU1™ tablets were calculated.

4.4.5 Determination of the stability of SU-B in Phyto Nova™ tablets and Promune™ capsules

To assess the effect of elevated environmental temperature and humidity on the physiochemical stability of the Phyto Nova™ tablets and Promune™ capsules triplicate set of each product were placed (exposed or in container) for 4 weeks in a Labcon Humidity Incubator FSIE-RH20, set at a temperature of 40⁰C and a relative humidity of 70%. Every second week triplicate samples of the products were moved from the climatic chamber. Each powder sample was extracted with methanol as described in section 4.4.4.4, and then immediately assayed for sutherlandioside B content. Again the levels of SU-B in each timed sample were determined from a standard curve that was prepared at the same time.

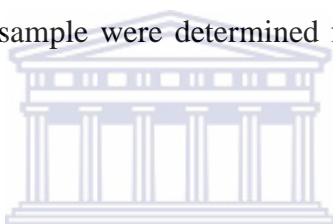

The sutherlandioside B concentration was calculated and this parameter was used to compare these 2 commercially available products. After assay, the rate of change in the SU-B content of the samples over the storage time was determined and compared against that which was stored at ambient conditions. From the degradation profiles, the time for 10% degradation (i.e. t_{90} or shelf life) was also calculated and compared to give an indication of the stability and hence shelf life of these products. The rate of degradation of the Phyto Nova™ tablets and the Promune™ capsules was compared against each other in both the sealed (unexposed) and unsealed (exposed) products and also against that stored at ambient conditions.

4.4.6 Determination of the stability of SU-B under hydrolytic conditions: Acid-induced degradation

To determine the stability of the SU-B under acidic conditions, 2mL of methanol extract of plant material, prepared according to procedures described in section 4.4.4.4, was refluxed with 2mL of 0.6M HCL. This solution was heated for 1 hour at 80⁰C in a water bath and left to cool overnight. The next day the solution was filtered and evaporated to dryness using a gentle stream of nitrogen gas. The dried residue was re-suspended in 2mL methanol, filtered through a 0.45 µm nylon membrane filter. The first 1.0 mL was discarded and the remaining volume was collected in an LC sample vial. Sample solutions were injected in triplicate and subjected to HPLC analysis, as described under 4.4.4. The effect the acid hydrolysis had on the SU-B, was assessed by comparing the amounts of SU-B in acid hydrolyzed samples with that not subjected to such hydrolysis.

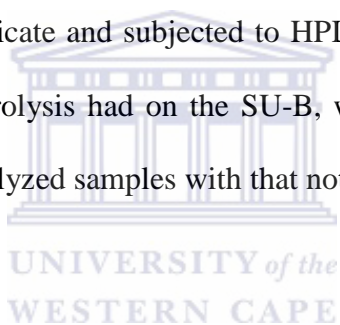



UNIVERSITY *of the*
WESTERN CAPE

CHAPTER FIVE

RESULTS AND DISCUSSION

5.1 Introduction

In this chapter, the results obtained during the preparation of the *S. frutescens* material, the extraction and isolation of sutherlandioside B, the development and validation of a suitable HPLC assay for the analysis of sutherlandioside B, comparison of the sutherlandioside B levels obtained in the two commercially available *S. frutescens* preparations and finally, the determination of the effect of elevated environmental temperature and relative humidity, as well as acid hydrolysis on the levels of sutherlandioside B in the two products are reported and discussed.

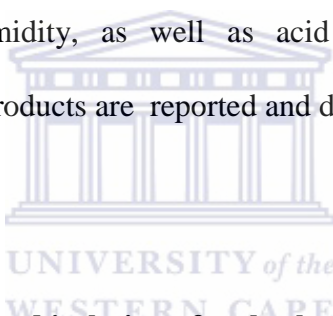

5.2 Collection, extraction and isolation of sutherlandioside B from plant material

In this project three types of *Sutherlandia* material were investigated, viz. that of the plant and that found in the 2 dosage forms, viz. Phyto Nova SU1™ tablets and the Promune™ capsules. The 2 commercial *Sutherlandia* products were obtained at a local health shop in Cape Town, whereas the *S. frutescens* plant raw material was purchased from Afriplex®, Cape Town. The company adheres to Good Agricultural Practice (GAP) and Hazard Analysis and Critical Control Point (HACCP) standards. A certificate of analysis (Appendix 1) and a voucher specimen was obtained from Afriplex® and further analyses were performed at SAHSMI, University of the Western Cape. The *S. frutescens* plant material was then extracted and subjected to column chromatographic fractionation as per

the method of Fu *et al.* (2008). When the 100g of dried leaf powder was extracted with methanol, 17.3g of a dried dark green methanol extract was obtained (i.e. with a yield of 17.3%), 1.756g of a dry brown *n*-BuOH residue and, eventually, 500mg of the suspected major triterpenoid, sutherlandioside B, at a final yield of 0.5%.

5.3 Identification of isolated sutherlandioside B from *S. frutescens*

To identify the isolated SU-B, qualitative (TLC) and quantitative (LC-MS and HPLC-UV) analyses were conducted. For the TLC, the best separation for the *n*-BuOH fraction was obtained with CHCl₃: MeOH [9:1] as mobile phase as depicted below in figure 4B. The CHCl₃: MeOH [3:2] mixture did not adequately separate the components (broad bands, figure 4A) in the *n*-BuOH fraction and also not the 50:50 mixture (figure 4C), where the *n*-BuOH fraction moved to the solvent front. Fractions collected from the silica gel column chromatography of the *n*-BuOH residue were thus subjected to this TLC using the CHCl₃: MeOH [9:1] mobile phase and those having the same TLC profiles were combined. Fractions 51-59, only had one single spot and were combined and subjected to semi-preparative TLC and yielded a single spot with a R_f value of 0.5 as seen in figure 5.

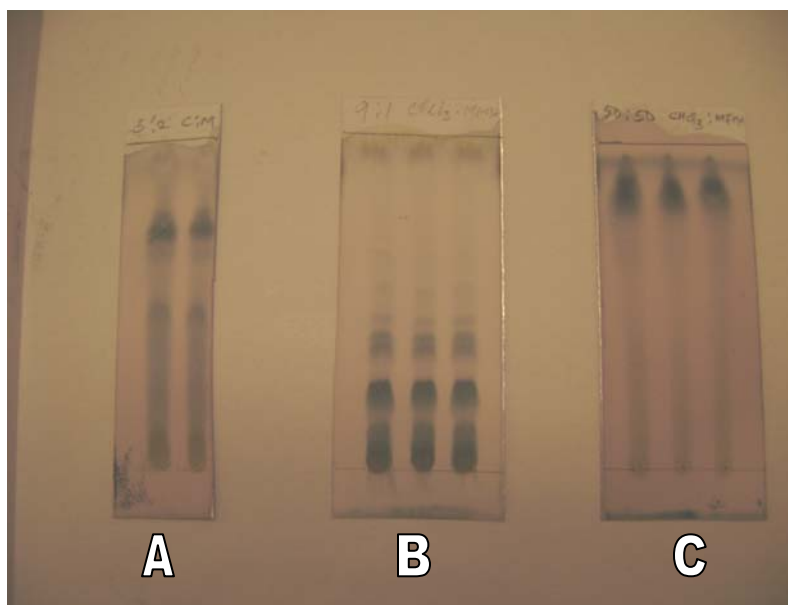

Fig 4: TLC plates of the *n*-BuOH fraction of *S. frutescens* developed under different mobile conditions. Mobile phase consisted of CHCl_3 :MeOH in ratio: A = 3:2; B = 9:1 and C = 50:50. For visualization, plates were sprayed with vanillin spray.

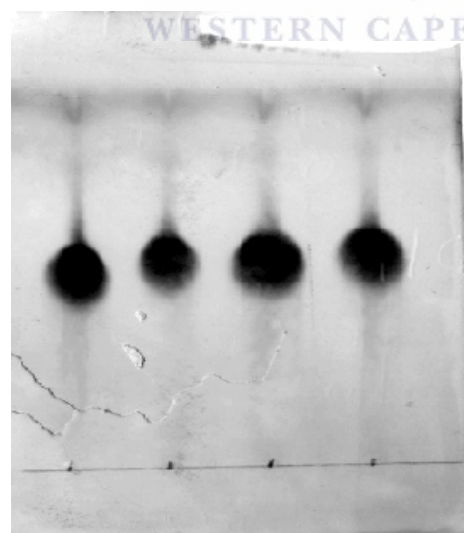

Fig 5: TLC plate of the isolated sutherlandioside B with mobile phase CHCl_3 :MeOH (9:1). To visualize, plates were sprayed with vanillin spray.

The identification of the sutherlandioside B spot, scraped from the TLC plate and dissolved in 5ml methanol, was then done by HPLC with a diode array (UV) detector set at wavelengths of 349 and 260nm and the results obtained are shown in figures 6 and 7. The SU B peak was separated on a Discovery® C-18 column using as mobile phase, 0.1% formic acid/acetonitrile (A) and 0.1% formic acid/dH₂O (B) and a linear gradient, starting at 15% (A)/ 85% (B) to 65% (A)/ 35% (B) over 20 minutes, followed by a 5 min wash with 100% (A) and an equilibration period (discussed in more detail in section 4.4.4.2).

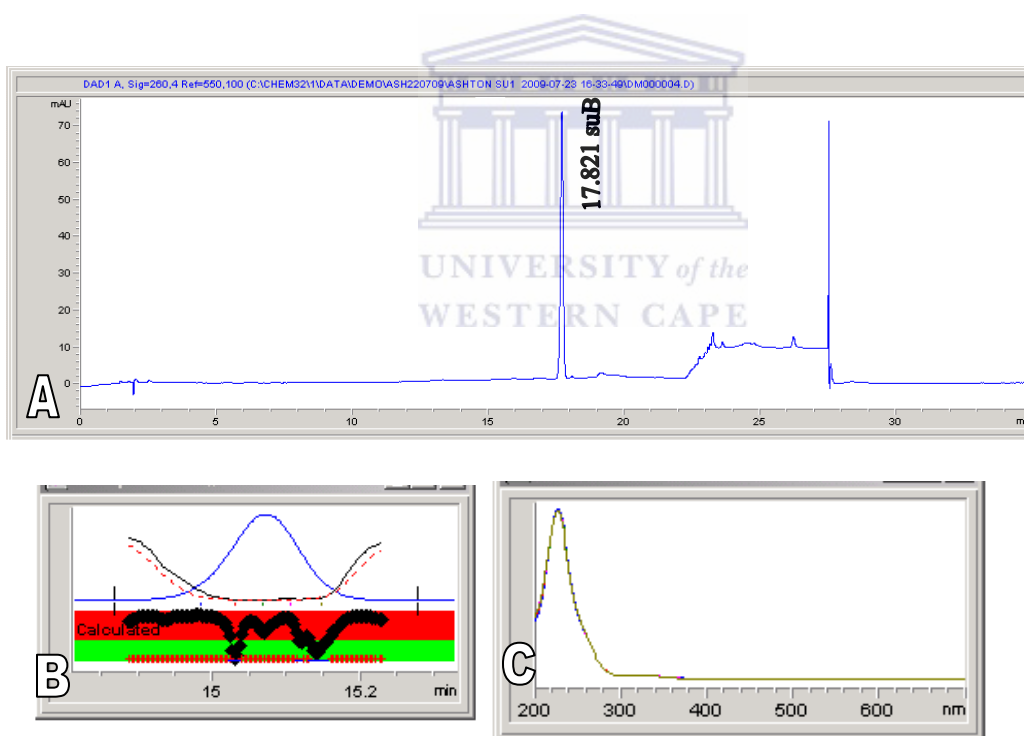

Fig 6: Representative HPLC chromatogram at 260nm (A), Peak purity trace or spectrum (B) and UV spectrum (C) of isolated sutherlandioside B standard. HPLC conditions as described in 4.4.4.2 were used and 10 µl of the 330 ug/ml standard solution was injected.

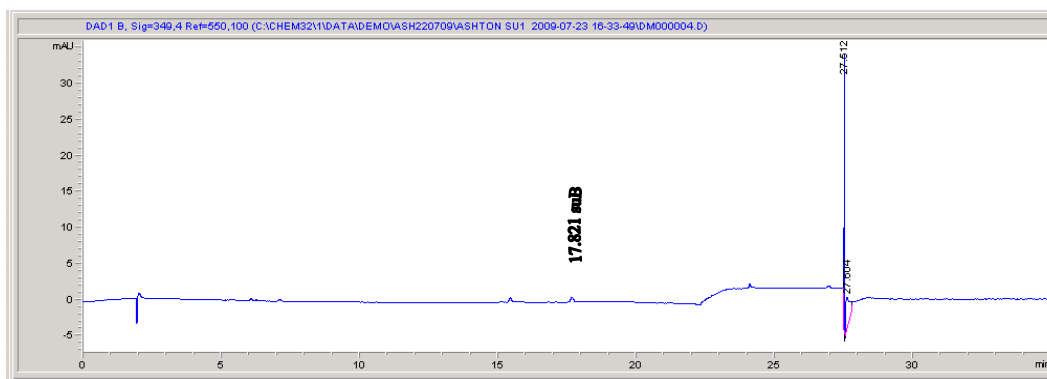
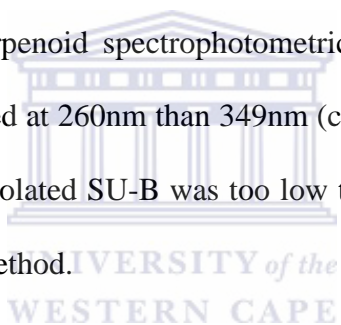

Fig 7: Representative HPLC chromatogram of isolated sutherlandioside B at 349 nm.

The isolated SU-B had a retention time of 17.821 ± 0.02499 minutes ($n=6$), was pure (figure: 6B), had a typical terpenoid spectrophotometric profile (figure: 6C) and was more notable and easily detected at 260nm than 349nm (compare figures 6A and 7). The absorbance at 349nm for the isolated SU-B was too low to quantitate and hence 260 nm was used for the final HPLC method.



The methanolic solution of the isolated SU B was also subjected to LC-MS analysis and in figures 8 and 9 the total ion chromatogram and the MS-MS fragmentation profile for the peak at retention time 3.723 minutes are presented. Tables 1 and 2 presents a summary of the mass spectra and key-fragment analysis data for the isolated sutherlandioside B obtained by LC-ESI-TOF method. The peak at retention time 3.723 min. had an exact mass of 652.4186 and the key mass fragments were similar to that reported by Fu *et al.*, (Fu *et al.*, 2008) and confirmed the identity of the isolated compound as SU B.

Figure 8: Total ion chromatogram of the isolated SU-B solution using LC-ESI-TOF method



Figure 9: MS-MS fragmentation profile for peak at retention time 3.723 minutes

Table 1: Mass spectra of sutherlandioside B identified using LC-ESI-MS with positive and negative scan mode

Analyte	Mass spectra negative ion (<i>m/z</i>)	Mass spectra positive ion (<i>m/z</i>)
Sutherlandioside B	651.4108 [M-H] ⁻	653.4257 [M+H] ⁺ 675.4117 [M+H] ⁺

Table 2: Key-fragment analysis of pure standard compound by LC-ESI-TOF method

Analyte	[M+H] ⁺	[M+H- Glu] ⁺	[M+H- H ₂ O] ⁺	[M+H- H ₂ O- glu] ⁺	[M+H- 2H ₂ O] ⁺	[M+H- 2H ₂ O-glu] ⁺	[M+H- 3H ₂ O] ⁺	[M+H- 3H ₂ O- Glu] ⁺	[M+H- 4H ₂ O- Glu] ⁺
SU B	653.4265	491.3718	635.4118	473.3631	617.4018	455.3541	599.3913	437.3397	419.32
652.4186									

The isolated SU B was then used to set up the calibration curve and to develop the validated HPLC method for the determination of sutherlandioside B in the 2 commercially available products viz, Phyto Nova™ tablets and the Promune™ capsules.

5.4 Development and validation of a HPLC assay for sutherlandioside B in the plant material

5.4.1 Development of HPLC assay

A reverse phase HPLC assay was developed and validated for the quantification of sutherlandioside B levels in the *Sutherlandia frutescens* plant material. Different HPLC

conditions were tested for the separation of the SU B peak from that of other compounds found in the chromatograms of both the aqueous extract dosage form and the dried leaf dosage form of *S.frutescens*. First, a Luna® C-18 (150 × 4.60mm, 5µm) analytical column was used, but the best separation of the terpenoids in *S. frutescens* plant material was, however, obtained with a Discovery C18 column purchased from Supelco®. Different mobile phases consisting of either methanol or acetonitrile with a mixture of different concentrations of acetic acid or formic acid in water, to control pH, were tried to optimize the chromatographic conditions. The best separation was, however, obtained when acetonitrile was used as organic phase instead of methanol. The formic acid was added to improve the peak symmetry of the compound and to suppress tailing. Therefore, as reported in section 4.4.4.2, the final mobile phase used consisted of a mixture of acetonitrile with 0.1% formic acid (A) and H₂O with 0.1% formic acid (B) with a linear gradient from 15 % (A) at time 0 to 65%(A) over 20 minutes, followed by 5 minute wash with 100% (A) and a final 10 minute equilibration period with 15% A before the next injection. The mobile phase was pumped at a constant flow rate of 1ml/min and the column kept at 40°C for the total duration of the run..

5.4.2 Validation of HPLC assay

The HPLC assay for the analysis of the SU-B levels in the *S. frutescens* plant material and the 2 commercial products was validated for specificity, separation, reproducibility, low limit of detection, inter-and intra-day variability and linearity.

Examples of a representative chromatogram obtained for the plant material are given in figure 10 and that for the isolated SU-B, obtained under similar HPLC conditions (described in section 4.4.4.2), in figure 6. The SU-B peak in the plant sample was symmetrical and had a retention time of 17.828 minutes \pm 0.0239($n=6$) that was in line with the retention time of the isolated SU-B of 17.821 minutes \pm 0.02499 ($n=6$). The plant material sample was also spiked with the pure standard SU-B solution (330 μ g/ml) and then injected onto the HPLC system as described in section 4.4.4.2. The SU-B peak now, as seen in figure 11, had a bigger peak area and height verifying that the peak in the plant sample chromatogram was given by SU-B. Also, the UV spectrophotometric profile of the SU-B in the plant material and spiked sample were similar to that in the authentic sample. Together the afore-mentioned findings indicated that the developed HPLC method was highly specific, selective and reproducible for the SU-B peak in *S. frutescens* plant material.

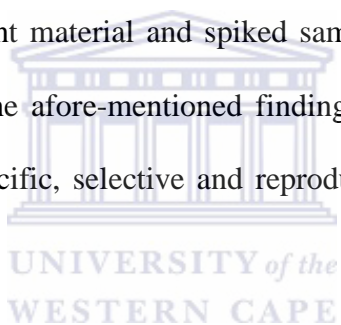

The chromatogram of the *S. frutescens* at 260nm also showed very prominent peaks (esp. between 6 to 8 min retention times, see figure 10) that had UV spectra that clearly indicated their characteristic flavonoid spectral profile. These peaks most likely were those of the sutherlandins A to D that had been identified by Fu et al (2008), but there further identification was not pursued in this study.

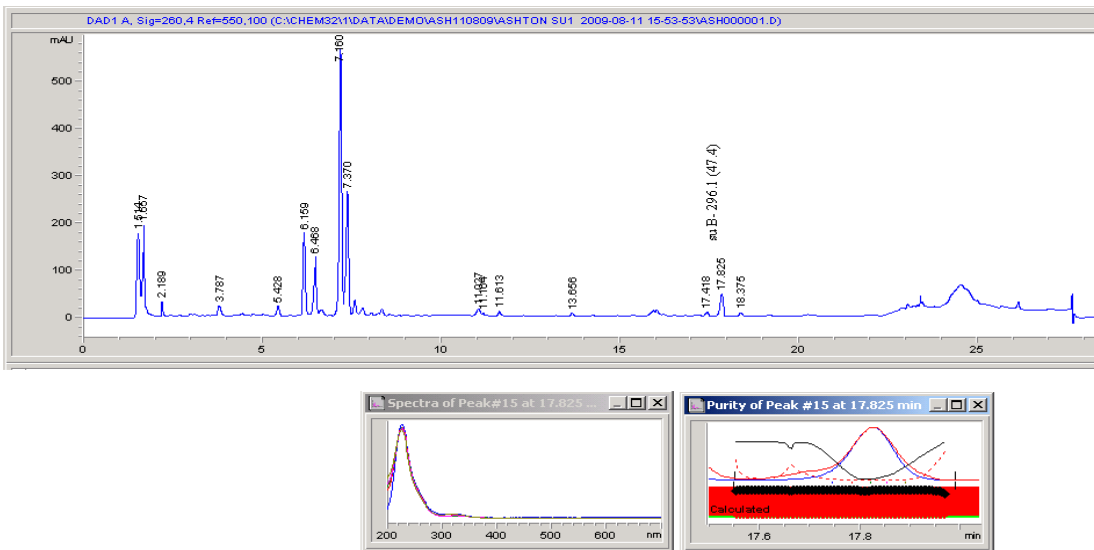

Figure 10: Chromatogram of *S. frutescens* plant material at 260 nm and the UV spectral and peak purity traces of the SU-B at 17.825 min are presented

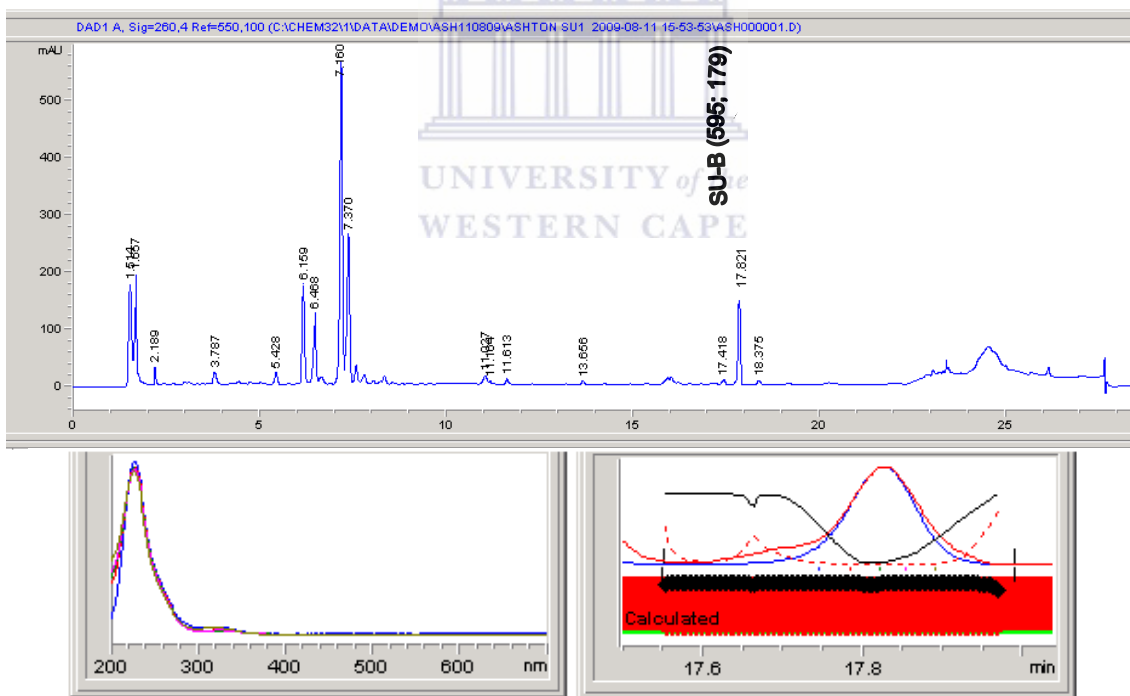

Figure 11: Chromatogram of *S. frutescens* plant material spiked with the isolated SU-B standard solution at 260 nm and the UV spectral and peak purity traces of the SU-B at 17.821 min are presented

The results obtained for the validation of the HPLC method are summarized in table 3 and figure 12. The five point calibration concentration *versus* peak area curve for sutherlandioside B (figure 12) showed a linear correlation, with $r^2 > 0.9999$, over the concentration range of 22 to 330 $\mu\text{g/mL}$ (table 3). The limit of detection (LOD) and limit of quantification (LOQ), defined as signal-to-noise ratios equal to 3 and 10, respectively, for the major cycloartanol glycoside were 0.5 and 22 $\mu\text{g/mL}$, respectively. Multiple injections showed that the results were highly reproducible and had low standard error, while the intra- and inter-day variation of the assay was lower than 3.0 % and the within day CVs for the replicates (n=6) at two different concentrations (22 and 55 μg) were 1.23%. The accuracy of the HPLC method was found to be >97% at all the concentration levels for all analyte (Table 3).

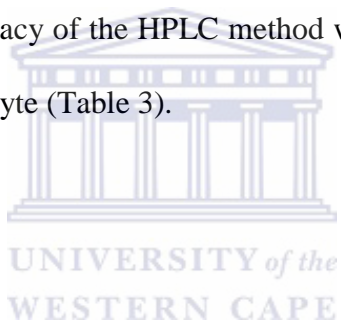

Table 3: Summary of validation parameters for the HPLC assay of sutherlandioside B in *S. frutescens* plant material

Slope (mAU/ $\mu\text{g/mL}$)	2.967 +/- 0.009261
Intercept (mAU)	-2.703 +/- 1.613
Correlation coefficient (r^2)	0.9999
Intra-day variability (CV%)	0.972%
Inter-day variability (CV%)	2.499%
Low limit of quantification	22 μg
Limit of detection	0.5 μg

Table4: Intra-and Inter-day accuracy for SU-B in *S. Frutescens*.

Analyte	Concentration (µg/mL)	Intra-DAY (n=5)			Inter-Day (n=15)		
		Found (µg/mL)	RSD (%)	Accuracy*	Found (µg/mL)	RSD (%)	Accuracy*
SU-B	22.0	22.35	1.45	101.4	21.76	1.78	99.04
SU-B	55.0	55.05	0.97	100.1	54.95	1.23	99.9

* Accuracy (%) = 100% x mean of measured concentration/ nominal concentration.

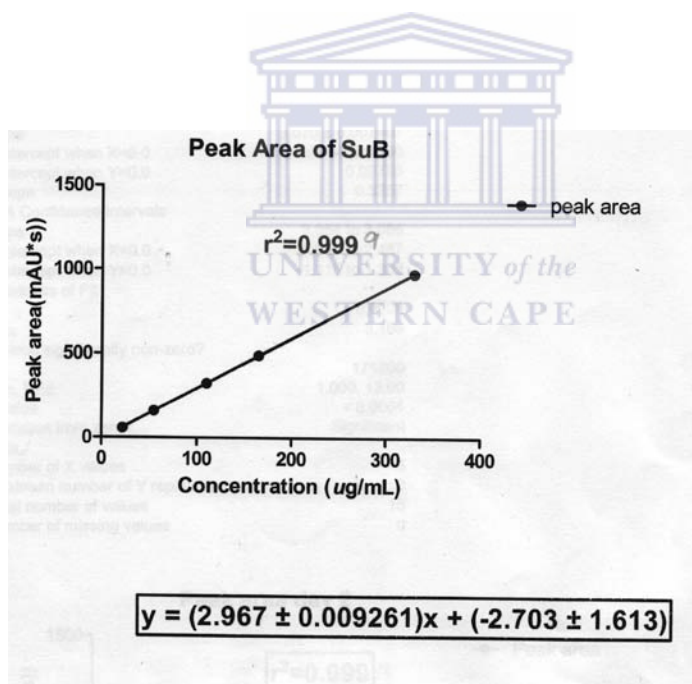

Figure 12: Standard curve of peak area versus concentration of sutherlandioside B levels in *S. frutescens*. Samples were subjected to HPLC and detected by UV absorption at 260 nm. Each data point represents mean (+/- SEM) of 3 replications.

Overall, the developed HPLC method for the determination of SU-B was found to be highly reproducible, specific, selective and accurate and amendable for routine use within SU-B concentration range of 22-330 µg/ml. Specifically, it was expected that this assay would be suitable for the assay of SU-B in *Sutherlandia* plant materials and dosage forms but would probably not be sensitive enough to use in *in vivo* bioavailability and pharmacokinetic studies.

5.4.4 Comparison of the sutherlandioside B levels in the Phyto Nova™ tablets and Promune™ capsules



The developed HPLC assay was then applied to determine how the Phyto Nova™ tablets and Promune™ capsules compared in terms of SU-B levels and chromatographic profiles. In addition, the aim of this study was also to determine if SU-B can be used as a marker to determine pharmaceutical quality and stability of these products. Representative chromatograms obtained for the two products are given in figures 13 and 14. The Phyto Nova *Sutherlandia*™ tablets made from the dried leaf powder had similar SU-B levels and chromatographic profiles than the raw *S. frutescens* plant material. On the other hand the Promune™ capsules had two distinctive extra peaks, viz one at 21.815 ± 0.0321 minutes ($n=6$) having a typical terpenoid spectrophotometric profile and one at 8.291 ± 0.0233 minutes. Because the extract in the Promune™ capsules is the freeze

dried aqueous extract of the same *S. frutescens* plant material (both the *S. frutescens* dried leaf powder and extract raw materials are supplied by the same manufacturer viz. Afriplex®, Paarl, South Africa), the most likely reasons for the presence of the 2 extra peaks could be (i) changes caused by the freeze drying process and/or (ii) the presence of inactive formulation additives. At this stage the presence of intentionally added active adulterants can however also not be excluded.

The SU-B peak was clearly seen in the chromatograms of both commercial products and its presence confirmed based on SU-B retention time and spectrometric profile and peak purity. For the Phyto Nova Sutherlandia™ tablet samples the SU-B peak had a retention time of 17.825 ± 0.0225 minutes ($n=6$), the same as the retention time of SU-B in the *S. frutescens* plant material. For the Promune™ capsule samples the SU-B had a retention time of 17.781 ± 0.0421 minutes ($n=6$).

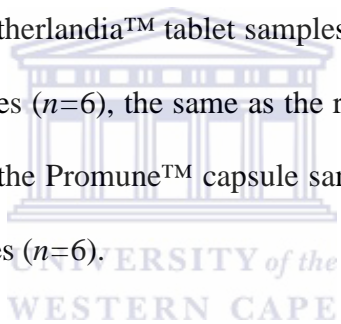

Generally the SU-B peak in the Phyto Nova Sutherlandia SU1™ tablets was greater in peak area and peak height than that for the Promune™ capsules, in fact the SU-B concentration were 1.73 ± 0.013 µg/mg in the Phyto Nova™ tablets compared to an average of 1.523 ± 0.016 µg/mg for the Promune™ capsules (table 4). The recommended daily dose for the Phyto Nova Sutherlandia™ tablets is one tablet twice daily which is the same as that for the Promune™ capsules, i.e. 1 capsule twice daily. However the Phyto Nova Sutherlandia™ tablets had a dosage weight of 500 mg per tablet (containing 300 mg of *S. frutescens* plant material) while that for the Promune™ capsules was 200 mg per capsule, (containing 90 mg of the freeze dried aqueous extract

of *S. frutescens*). Therefore the average dose of SU-B in the Phyto Nova Sutherlandia SU1™ tablets was significantly higher than that in the Promune™ capsules (i.e. $1.73 \times 300 \text{ mg} \pm 0.013$ vs. $1.523 \times 90 \text{ mg} \pm 0.016$, respectively; $p = 0.05$).

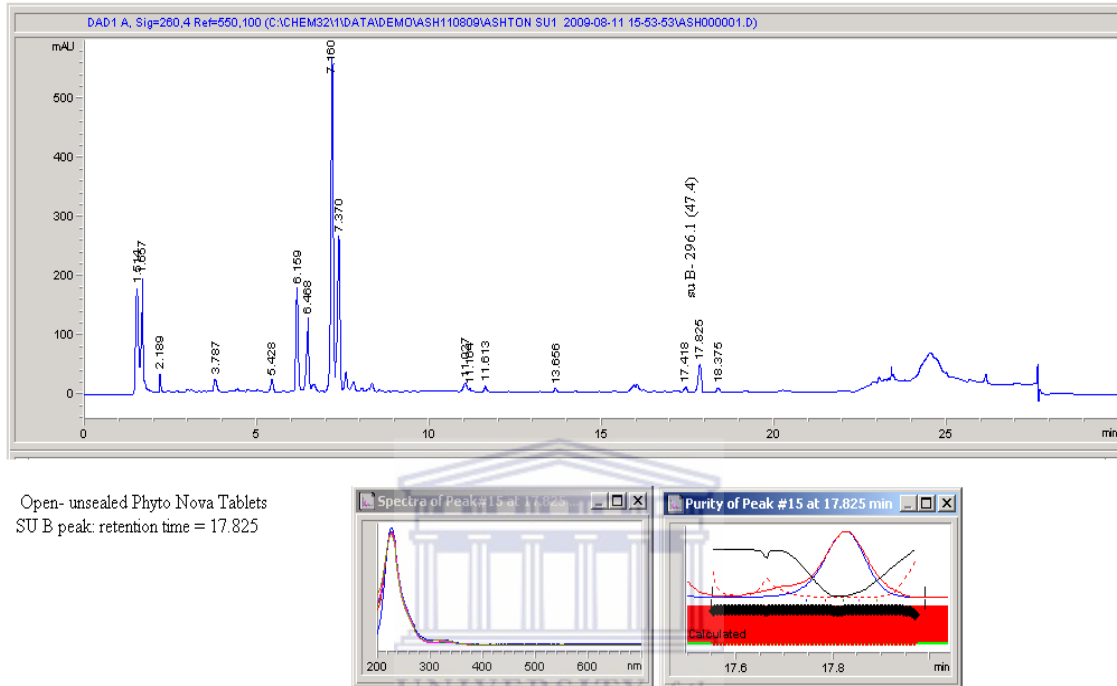
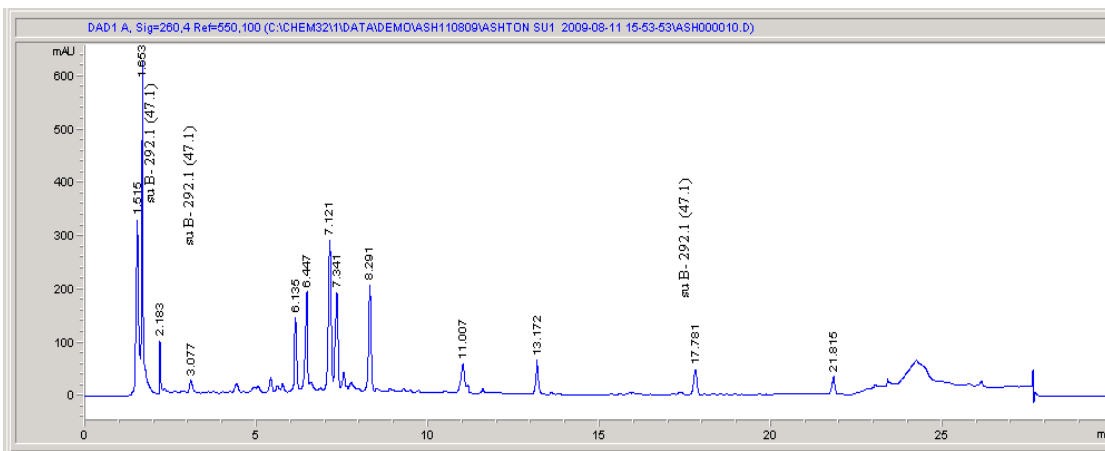

Fig 13: Representative HPLC chromatogram and UV spectra of SU-B in the Phyto Nova™ tablets



Closed- sealed Promune caps
Ret. 17.781;

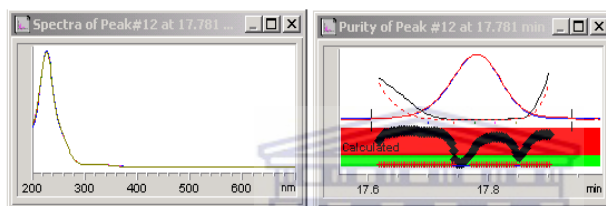
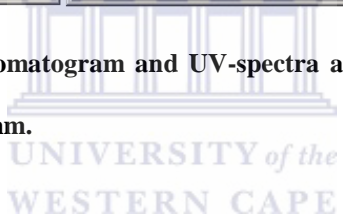

Fig 14: Representative HPLC chromatogram and UV-spectra and purity of the SU-B peak in the Promune™ capsules at 260nm.



Clearly both the Phyto Nova Sutherlandia SU1™ tablets and the Promune™ capsules contained appreciable amounts of SU-B. If SU-B was a major contributor to the activity of *Sutherlandia* then the Phyto Nova Sutherlandia SU1™ tablets will, based on the results of this study and contrary to the Promune™ manufacturer's claims, actually be significantly more active than the Promune™ capsules on a daily dose basis. The presence of SU-B in both these products also strongly suggests that it could be used as a marker to determine the stability, shelf-life and pharmaceutical quality of such *Sutherlandia* commercial products.

5.5 The effect of elevated environmental temperature and relative humidity on the SU B levels in the Phyto Nova™ tablets and Promune™ capsules

The next objective was to determine if the developed HPLC method for sutherlandioside B could be used as a stability indicating HPLC assay to determine the pharmaceutical quality, like the shelf life of these commercially available *S. frutescens* products. To accomplish this, it had to be ascertained if changes in SU-B levels which rose during storage under inappropriate conditions, such as elevated environmental temperature and humidity conditions that could lead to product degradation could be discerned with this assay.

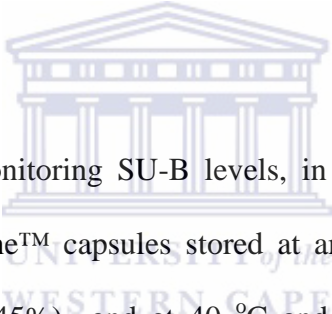

The results obtained when monitoring SU-B levels, in the Phyto Nova Sutherlandia SU1™ tablets and the Promune™ capsules stored at ambient temperature (25°C) and environmental humidity (RH=45%) and at 40 °C and 70% relative humidity over 4 weeks are given in table 5. The SU-B levels in the two dosage forms stored in sealed (i.e. capsule or tablet in air tight container) and unsealed containers (containers with no lid) under the 2 sets of conditions were monitored. The SU-B level in the Phyto Nova™ tablets stored under ambient conditions were 1.73 ± 0.013 µg/mg at the start and changed minimally over the 4 weeks storage time (i.e. 1.688 ± 0.009 µg/mg at week 4). The SU-B in the tablets stored, both sealed and unsealed, under the elevated conditions (40°C & 70% RH) however, decreased by 38.27% and 41.68 %, respectively, after 4 weeks of storage. Similarly, the SU-B level in the Promune™ capsules stored under ambient conditions at the start was 1.523 ± 0.016 µg/mg, remained almost unchanged at week 4,

containing $1.491 \pm 0.012 \mu\text{g}/\text{mg}$, while that in the capsules stored sealed and unsealed at the elevated temperature and humidity conditions decreased significantly by 34.08% and 35.13%, respectively, over the weeks storage period.

Table 5: Sutherlandioside B content in the Sutherlandia tablet (Phyto Nova™) and capsule (Promune™) during 4 weeks storage under ambient and elevated temperature and humidity conditions.

TIME	SU-B CONCENTRATION IN PHYTO NOVA SU1™ (ug/mg?)			SU-B CONCENTRATION IN PROMUNE™(ug/mg?)		
	Ambient Conditions	Elevated conditions Sealed	Elevated conditions Unsealed	Ambient conditions	Elevated Conditions Sealed	Elevated conditions Unsealed
0	1.731± 0.013	1.731± 0.013	1.731± 0.013	1.523±0.016	1.523±0.016	1.523±0.016
2	1.701± 0.011	1.651±0.017	1.455±0.017	1.501±0.014	1.276±0.012	1.264±0.012
4	1.688± 0.011	1.068±0.010	1.009±0.010	1.491±0.012	1.001±0.011	0.9880.011

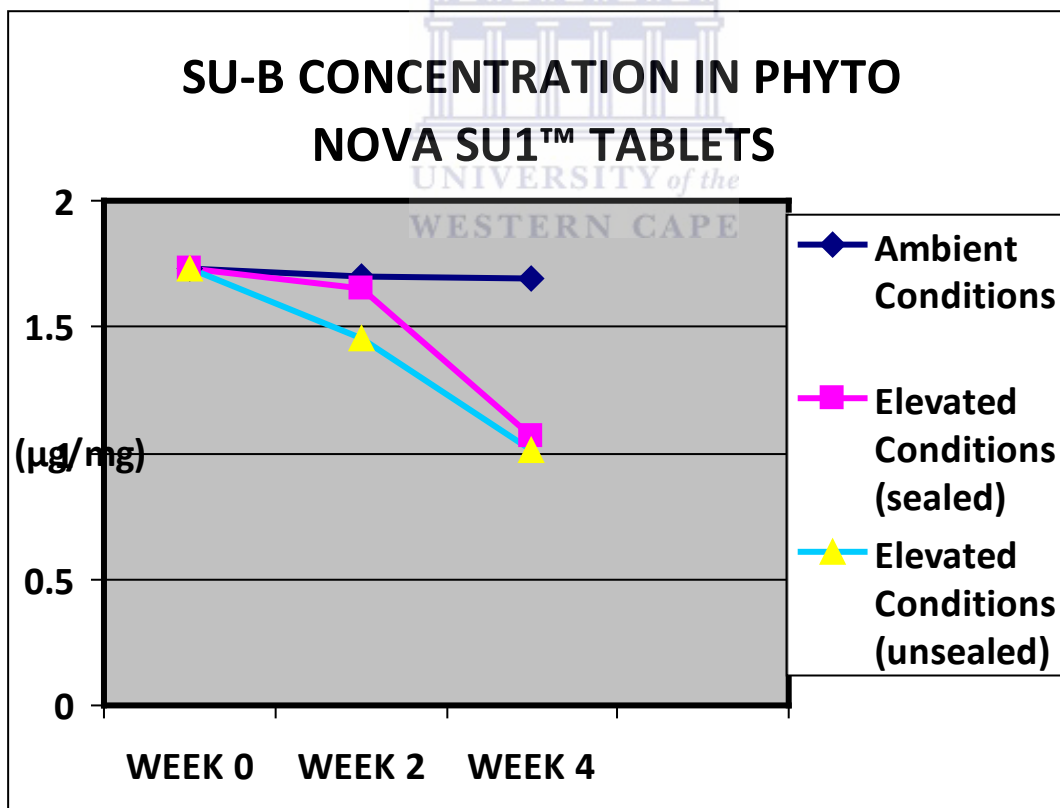
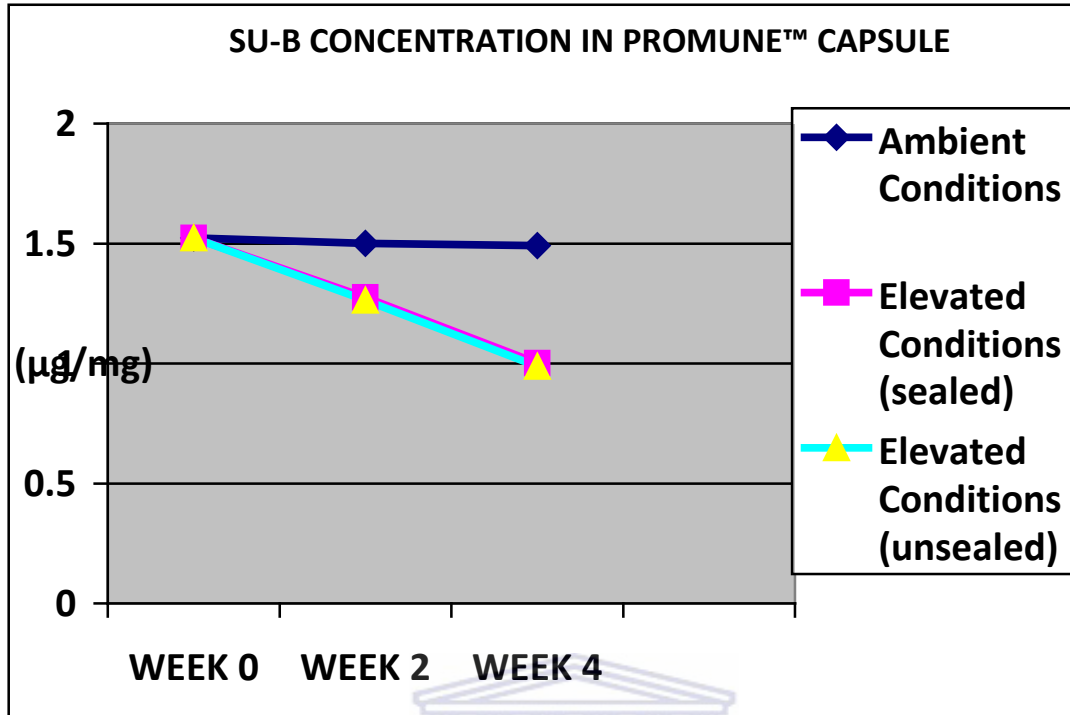

Figure 15: SU-B concentration in Phyto Nova Sutherlandia SU1™ tablets and Promune™ capsules during 4 weeks storage under ambient and elevated temperature and humidity conditions

The above mentioned results also suggested, that when *Sutherlandia* capsules and tablets are subjected to elevated temperature and humidity conditions possible degradation (indicated by SU-B loss) is more pronounced when the products are unsealed (i.e. not in container). In addition, the tablets were more sensitive than capsules when subjected to these stressful conditions and degraded faster than under elevated temperature and humidity conditions (table 5), in both the sealed and unsealed containers over the four week period. Reasons to account for the tablets degrading faster than the capsules over a period of four weeks, may include the manufacturing process, packaging material, storage, temperature and humidity. The manufacturing procedures differed from one company to another, and this could have impacted on the stability of the tablets and capsules. The Promune™ capsules contained the freeze dried aqueous extract of *S. frutescens*, which involves a freeze-dried process, which is a different manufacturing process used compared to that used for the Phyto Nova *Sutherlandia*™ tablets, which is made from the dried leaf powder.

Upon purchase, the expiry dates of the *Sutherlandia* tablets and capsules were 10/2010 and 12/2010, respectively, however, the data obtained in this study were insufficient to clear if the assigned expiry dates were correct. The shelf-life of a product is based on its storage at ambient temperature over a two year period, however, accelerated testing is usually only done to speed up the process and to identify the breakdown products. Accelerated testing is usually done under 3 or more different conditions & then an Arrhenius plot is drawn (i.e. graph of temp vs. degradation rate) and extrapolated to get the degradation rate for ambient (e.g. 25⁰ C) conditions, and the latter calculated rate

value used to predict the shelf-life. Accelerated testing may, however, not work for herbals (i.e. it may be problematic to determine the shelf life of herbal products). However this issue needs further investigation.

Collectively, the results clearly suggests, that while both the Phyto Nova™ tablets and Promune™ capsules may be quite stable under ambient storage conditions, the quality of both dosage forms may degrade quite appreciably under elevated environmental temperature and humidity. Moreover, the tablets appeared to be more susceptible to degradation under the elevated storage conditions than the capsules. Most important (for this study) was, however, the fact that such instability could be indicated using the HPLC assay developed in this study.

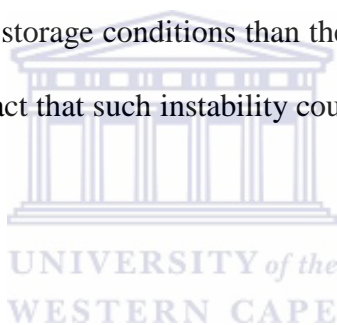

5.6 The effect of acid hydrolysis on the SU B levels in the Phyto Nova™ and the Promune™ capsules

Sutherlandioside B (SU-B), the focus of this investigation, is the major cycloartanes glycoside of *Sutherlandia* (Fu *et al.*, 2008). Hydrolytic removal of the sugar moiety (i.e. the β -glucopyranosyl moiety at C25) may thus be a possible degradative pathway for this potential active constituent of *Sutherlandia*. *Sutherlandia* also contain glycosides of other terpenoids and flavonoids (Fu *et al.*, 2008 & 2009) and sometimes in assays of such

glycosides the samples are subjected to acid hydrolysis to remove the sugar moiety and present the respective aglycones. If SU-B is to be a useful marker to monitor the pharmaceutical quality of *Sutherlandia*-containing products, it would thus be important to know if SU-B is susceptible to such hydrolytic degradation, and if such a step must be avoided in the assay to determine the SU-B levels in *Sutherlandia* plant material or dosage forms. In addition, for SU-B in the Phyto Nova SU1™ tablets and Promune™ capsule to, as the glycoside, contribute to the *in vivo* activity of these orally administered plant medicinal products, it must (as the glycoside) be stable in the gastrointestinal tract and bioavailable (i.e. appreciably absorbed from the gastrointestinal tract into the systemic circulation).

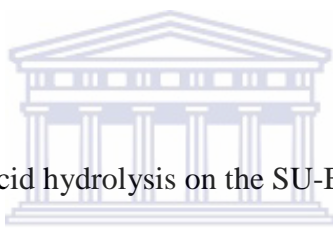

Given the above, the effect of acid hydrolysis on the SU-B levels in the 2 products was thus investigated in this study. To do so solutions of the powder of the Phyto Nova™ tablets (100mg/ml) and of the Promune™ capsule (40mg/mL) were subjected to acid hydrolysis using 0.6M HCl at 80⁰ C for 1 hour and the SU-B assayed by HPLC and UV absorption at 260nm (see methods section 4.4.4. and 4.4.6).

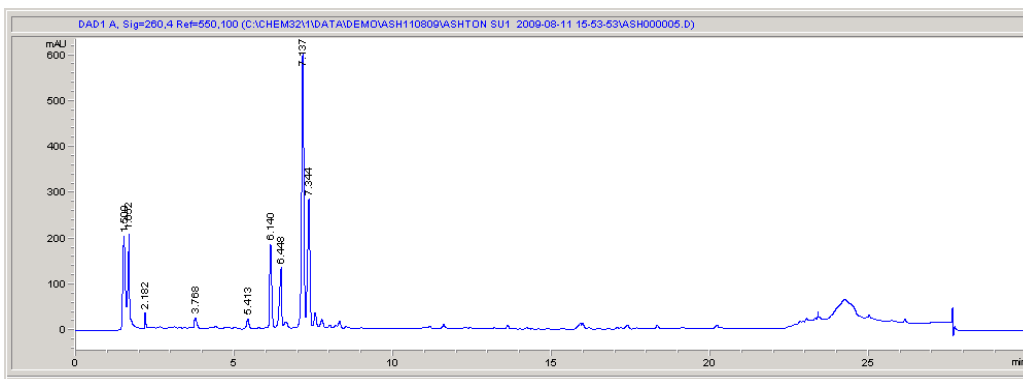

Fig. 16: Representative HPLC chromatogram of an acid-hydrolyzed solution of the PhytoNova™ tablet powder. The effluent was monitored at at 260nm and the SU-B peak expected at retention time = 17.825 min was absent.

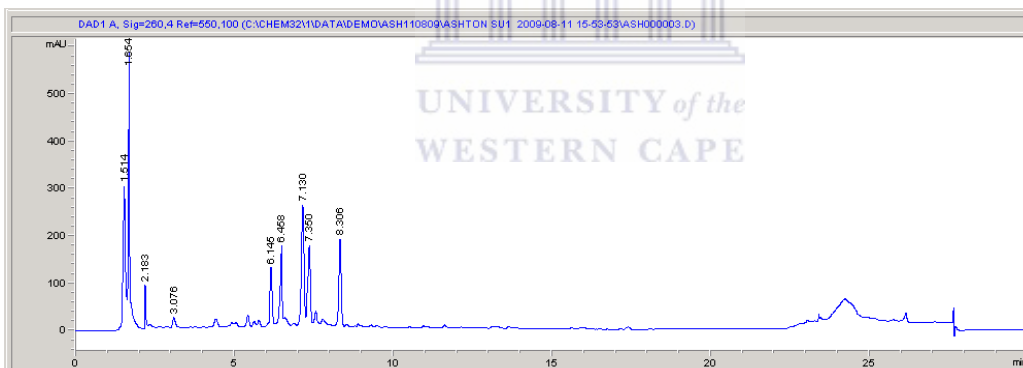

Fig. 17: Representative HPLC chromatogram of an acid-hydrolyzed solution of the Promune™ capsule powder. The effluent was monitored at at 260nm and the SU-B peak expected at retention time = 17.781 min was absent.

For both the Phyto Nova™ as well as the Promune™ the SU B peak in essence disappeared, as seen in figures 16 and 17, suggesting its complete break down and clearly indicating the susceptibility of the SU-B to acid hydrolysis. From these results it is also

very likely that SU-B may not remain intact in the acidic environment in the gastrointestinal tract for very long and thus not have high oral bioavailability. In addition, when assaying *Sutherlandia* for SU-B levels, an acid hydrolysis step must be avoided if the intact glycoside is to be monitored. Finally, and more importantly, the results obtained indicated that the assay developed in this investigation can indicate SU-B degradation (by acid) and can thus be used to monitor *Sutherlandia* product stability.



CHAPTER SIX

CONCLUSION AND RECOMMENDATIONS

The objectives of this study were, firstly, to develop a validated stability- indicating HPLC assay for sutherlandioside B (SU-B), to compare the levels of SU-B in the dried leaf powder dosage form, Phyto Nova Sutherlandia SU1™ tablets and the freeze-dried aqueous extract dosage form, Promune™ capsules, and thirdly, to determine the effect of elevated temperature and humidity as well as acid hydrolysis on the levels of SU-B in these commercially available *Sutherlandia frutescens* products.

From the results, obtained the following conclusions could be drawn:

1. A sensitive, reproducible HPLC assay that could be used to determine sutherlandioside B levels in *S. frutescens* plant raw materials and in two commercially available *S. frutescens* oral dose products viz. Phyto Nova Sutherlandia™ tablets and the Promune™ capsules, was developed. The SU-B was separated on a Discovery C-18 column, eluted with mobile phase consisting of mixture of water/acetonitrile with formic acid and detected by diode array detector set at 260nm. The assay was accurate, precise and reproducible over a SU-B concentration range of 22-330µg/ml and had limits of detection (LOD) and quantification (LOQ) of 0.5 and 22 ug/ml, respectively.
2. Both the dried leaf powder dosage form, Phyto Nova Sutherlandia SU1™ and the freeze-dried aqueous extract, *Promune*™ contain the major cyclo-artane glycoside,

sutherlandioside B. The Phyto Nova *Sutherlandia* SU1™ tablets had an average SU-B concentration of $1.73 \pm 0.013 \mu\text{g}/\text{mg}$ and the Promune™ capsules an average of $1.523 \pm 0.016 \mu\text{g}/\text{mg}$, resulting in the average daily dose of SU-B being ingested when taking the Phyto Nova *Sutherlandia* SU1™ tablets being significantly higher than that for the Promune™ capsules (i.e. 519.0 vs 137.17 μg , respectively). Based on these results and contrary to the Promune™ manufacturer's claims, the Phyto Nova *Sutherlandia* SU1™ tablets might, based on SU-B levels, actually be four times more active than the Promune™ capsule on a daily dose basis.

3. The HPLC profile of potential active constituents of the 2 commercially available *Sutherlandia* containing products i.e. the dried leaf powder tablet, Phyto Nova *Sutherlandia* SU1™ and the freeze-dried aqueous extract containing capsule, Promune™ were not the same. The Phyto Nova *Sutherlandia*™ tablets have similar HPLC fingerprints and SU-B levels than the raw *S. frutescens* plant material, whereas the Promune™ capsules had two distinctive extra peaks, viz. one at 21.815 ± 0.0321 minutes ($n=6$) having a typical terpenoid spectrophotometric profile and one at 8.291 ± 0.0233 minutes with a characteristic flavonoid.spectrophotometric profile, that could be due to the freeze-dried process.
4. The sutherlandioside B in commercially available *sutherlandia* containing solid dose preparations are susceptible to degradation under high temperature and humidity and acid hydrolysis conditions. This means. firstly, that SUB should thus be a good chemical marker to use to establish the stability and shelf life of

such preparations. While the Phyto Nova™ tablets and Promune™ capsules may be quite stable under ambient storage conditions whether accelerated stability testing methods can be used to determine shelf-life of sutherlandia herbal products is however a still unresolved matter. Secondly, the susceptibility of SUB to acid hydrolysis also indicate that SU-B may not remain intact in the acidic environment in the gastrointestinal tract for very long and thus not have high oral bioavailability.

5. Finally, the assay developed in this study could indicate SUB breakdown under elevated temperature and humidity and acidic conditions; it was thus stability indicating.

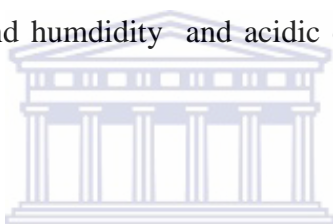

Collectively, the results of this study indicated that the developed HPLC assay for sutherlandioside B could be suitable (can be used) as a stability indicating assay for use in the control of the pharmaceutical quality of solid dosage forms (tablets or capsules of *Sutherlandia*). The developed assay is fast, easy to use, sensitive and selective with good linearity and amendable for routine use to establish the stability and hence quality of commercially available sutherlandia products. Most important (for this study), was however, the fact that such instability (degradation by elevated temperature, humidity and acid) could be indicated using the HPLC assay developed in this study and could thus be used to monitor *Sutherlandia* product stability. This study also provides valuable preliminary data on the stability profile of *Sutherlandia* tablets and capsules that should be useful for any future quality control studies on this medicinal plant.

In addition to the above conclusions, the following are recommended:

1. Further studies are required to determine the acceptable storage conditions for these dosage forms of *Sutherlandia*, e.g. container specifications, hygroscopicity of the material, sensitivity to light etc.
2. Aspects regarding the shelf life of these products also need to be pursued to determine the correct expiry dates
3. The effect of medium (e.g pH, surfactants) on the SU-B levels in *S. frutescens* plant material.
4. Determination of bioequivalence of these two products.

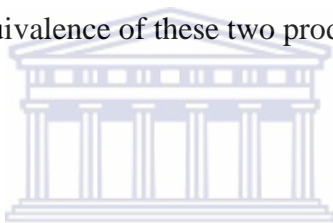

Overall, the results of this study provide valuable information about SU-B as marker compound for the determination of the pharmaceutical stability and the effect of stress conditions on the stability and pharmaceutical qualities of these commercially available herbal products.

A LIST OF REFERENCES

Anfossi, G., Massucco, L.M., Cavalot, P.P., Giori, A., Tassone, F., Travati, M., 1999. *Modulation of human platelet function by L-canavanine: differential effects of low and high concentrations.* General Pharmacology 32, 321-328.

Apers, S., Foriers, A., Sindambiwe, J.B., Vlietinck, A., Pieters, L., 1998. *Separation of a triterpenoid saponin mixture from Maesa lanceolata: semipreparative reversed-phase wide pore high performance liquid chromatography with temperature control.* Journal of Pharmaceutical and Biomedical Analysis 18, 737-743.

Bates, S.H., Jones, R.B., Bailey, C.J., 2000. *Insulin-like effect of pinitol.* British Journal of Pharmacology 130, 1944-1948.

Bence, A.K., Worthen, D.R., Adams, V.R., Crooks, P.A., 2002. *The antiproliferative and immunotoxic effect of L-canavanine.* Anti-Cancer Drugs 13, 313-320.

Bessong, P.O., Rojas, L.B., Obi, L.C., Tshisikawe, P.M., Igunbor, E.O., 2006. *Futher screening of Venda medicinal plants for activity against HIV type 1 reverse transcriptase and integrase.* African Journal of Biotechnology 5, 526-528.

Bianchini, R.M., Castellano, P.M., Kaufman, T.S., 2008. *Validated stability-indicating HPLC method for the determination of pridinol mesylate. Kinetics study of its degradation in acid medium.* Journal of Pharmaceutical and biomedical Analysis 48, 1151-1160.

Brümmerhoff, S.W.D., 1969. *Some constituents of Sutherlandia microphylla.* DSc Thesis, University of the Free State, Bloemfontein.

Chadwick, W.A., Roux, S., Van de Venter, M., Louw, J., Oelofsen, W., 2007. *Anti-diabetic effects of Sutherlandia frutescens in Wistar rats fed a diabetogenic diet.* Journal of Ethnopharmacology 109, 121-127.

Chaffy, N., Stokes, T., 2002. *Aids herbal therapy.* Trends in Plant Science 7, 57.

Chinkwo, K.A., 2005. *Sutherlandia frutescens extracts can induce apoptosis in cultured carcinoma cells.* Journal of Ethnopharmacology 98, 163-170.

Davies, A., Christensen, M., Horowitz, J.F., Plein, S., Hellerstein, M.K., Ostlund Jr, R.E., 2000. *Effect of pinitol treatment on insulin action in subjects with insulin resistance.* Diabetes Care 23, 1000-1005.

FDA, "Analytical Procedures and Methods Validation: Chemistry, Manufacturing and Controls Documentation; Availability," *Federal Register (Notices)* **65**(169), 52776–52777 (2000).

www.fda.gov/cder/guidance/cmc3.pdf

Fennell, C.W., Lindsey, K.L., McGraw L.J., Sparg, S.G., Stafford, G.I., Elgorashi, E.E., Grace, O.M., Van Staden, J., 2004. *Assessing African medicinal plants for efficacy and safety: pharmacological screening and toxicology*. Journal of Ethnopharmacology, 94, 207-217.

Fernandes, A.C., Cromarty, A.D., Albrecht, C., Jansen Van Rensburg, C.E., 2004. *The antioxidant potential of Sutherlandiafrutescens*. Journal of Ethnopharmacology 95, 1-5.

Fu, X., Li, X., Smillie, T.J., Carvalho, P., Mabusela, W., Syce, J.A., Johnson, Q., Folk, W., Avery, M.A., Khan, I.A., 2008. *Cycloartane Glycosides from Sutherlandia frutescens*. Journal of natural products 71, no.10.

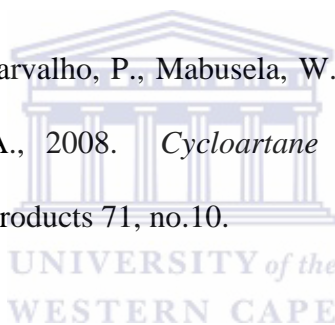

Gabrielse, V.S., 1996. *Pharmacological studies on rooperol, rooperol derivatives and Sutherlandia extracts*. MSc Thesis, University of Stellenbosch.

Gericke, N., Albrecht, C.F., Van Wyk, B., Mayeng, B., Mutwa, C., Hutchings, A., 2001. *Sutherlandia frutescens*. Australian Journal of Medical herbalism 13, 9-15.

Goldbatt, P., Manning, J., 2000. *A conspectus of the Cape Flora of South Africa*. Strelitzia 9. National Botanical Institute, Pretoria.

Good Manufacturing Practices, Annex 11, Guidelines for the assessment of Herbal medicines, World Health Organization (WHO) page 178, 179

Grandi, M., Roselli, L., Vernay, M., 2005. *Lessertia (Sutherlandia frutescens) and fatigue during cancer treatment*. *Phytotherapie* 3, 110-113.

Green, M.H., 1988 (filed 25 Jan.). *Method of treating viral infections with amino acid analogs*. United States Patent no. 5, 110, 600.

Greenwood, M., Kreider, R.B., Rasmussen, C., Almada, A.L., Earnest, C.P., 2001. *D-pinitol augments whole body creatine retention in man*. *Journal of Exercise Physiology* 4, 41-47.

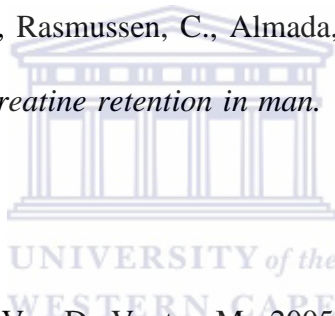

Harnett, S.M., Oosthuizen, V., Van De Venter, M., 2005. *Anti-HIV activities of organic and aqueous extracts of Sutherlandia frutescens and Lobostemon trigonus*. *Journal of Ethnopharmacology* 96, 113-119.

Havsteen, B.H., 2002. *The biochemistry and medical significance of the flavanoids: Review article*. *Pharmacology and Therapeutics* 96, issue 2-3, 67-202.

Hollman, P.C.H., Katan, M.B., 1999. *Dietary flavanoids: Intake, Health Effects and Bioavailability*. *Journal of Food and Chemical Toxicology* 37, 937-942.

International Conference on Harmonization, "Q2A: Text on Validation of Analytical Procedures," *Federal Register* **60**(40), 11260–11262 (1995).

International Conference on Harmonization, "Q2B: Validation of Analytical Procedures: Methodology; Availability," *Federal Register* **62**(96), 27463–27467 (1997).

Johnson, Q., Syce, J., Nell, H., Rudeen, K., Folk, W.R., 2007. *A randomized, double-blind, placebo-controlled trial of Lessertia frutescens in healthy adults.* PloS Clinical Trial 2 (4), art. No. e16.

Katerere, D.R., Eloff, J.N., 2005. *Antibacterial and antioxidant activity of Sutherlandia frutescens (Fabaceae), a reputed anti-HIV/AIDS phytomedicine.* Phytotherapy Research 19, 779-781.

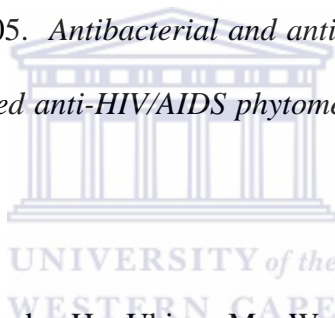

Kikuchi, T., Akihisa, T., Tokuda, H., Ukiya, M., Watanabe, K., Nishino, H., 2007. *Cancer chemopreventive effects of cycloartane-type and related triterpenoids in in vitro and in vivo models.* Journal of Natural Products 70, 918-922.

Kundu, J.K., Mossanda, K.S., Na, H-K., Surh, Y-J., 2005. *Inhibitory effects of the extracts of Sutherlandia frutescens (L.) R.Br. and Harpagophytum procumbens DC. On phorbol ester-induced COX-2 expression in mouse skin: AP-1 and CREB as potential upstream targets.* Cancer Letters 218, 21-31.

Levy, B., Valtier, M., deChillou, C., Bollaert, P.E., Cane, D., Mallie, J.P., 1999. *Beneficial effects of L-canavanine, a selective inhibitor of inducible nitric oxide synthase, on lactate metabolism and muscle high energy phosphates during endotoxic shock in rats.* Shock 11, 98-103.

Mills, E., Cooper, C., Seely, D., Kanfer, I., 2005. *African herbal medicines in the treatment of HIV: Hypoxis and Sutherlandia. An overview of evidence and pharmacology.* Nutrition Journal 4, 1-6.

Morris, K., 2001. *Treating HIV in South Africa- a tale of two systems.* The Lancet 357, 1190.



Moshe, D., 1998. *A biosystematic study of the genus Sutherlandia R.Br. (Fabaceae, Galegeae).* MSc Thesis (Botany), University of Johannesburg.

Muganga, R., 2004. *Luteolin levels in selected folkloric preparations and the bioavailability of luteolin from Artemisia afra aqueous extract in the vervet monkey.* Dissertation for a degree of Master's in Pharmacy at the University Of The Western Cape, Bellville.

Na, H-K., Mossanda, K.S., Lee, J-Y., 2004. *Inhibition of phorbol ester-induced COX-2 expression by some edible African plants.* BioFactors 21, 149-153.

Nuutila, A.M., Kammiovirta, K., Oksman-Caldentey, K.-M., 2001. *Comparison of methods for the hydrolysis of flavonoids and phenolic acids from onion and spinach for HPLC analysis.* Food Chemistry 76, 519-525.

Ojewole, J.A.O., 2004. *Analgesic, anti-inflammatory and hypoglycemic effects of Sutherlandiafrutescens R.Br. (variety incana E.Mey.) [Fabaceae] shoot aqueous extract.* Methods and Findings in Experimental and Clinical Pharmacology 26, 409-416.

Ojewole, J.A.O., 2008. *Anticonvulsant property of Sutherlandia frutescens R.Br. (variety incana E.Mey.) [Fabaceae] shoot aqueous extract.* Brain Research Bulletin 75, 126-132.

Ortega, A., 2003. *A new role for GABA: inhibition of tumor cell migration.* Trends in Pharmacological Science 24, 151-154.

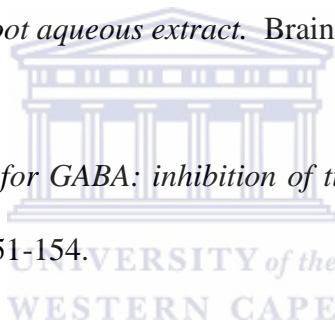

Ostlund, R.E., Sherman, W.R., 1996 (filed 4 March). *Pinitol and derivatives thereof for the treatment of metabolic disorders.* United States Patent no. 5,8827,896.

Prevoo, D., Smith, C., Swart, P., Swart, A.C., 2004. *The effect of Sutherlandia frutescens on steroidogenesis: Confirming indigenous wisdom.* Endocrine Research 30, 745-751.

Prevoo, D., Swart, P., Swart, A.C., 2008. *The influence of Sutherlandia frutescens on adrenal steroidogenic cytochrome P450 enzymes.* Journal of Ethnopharmacology 118, 118-126.

Rosenthal, G.A., 1997. *L-Canaline: a potent antimetabolite and anti-cancer agent from leguminous plants*. Life science 60, 1635-1641.

Roberts, M., 1990. *Indigenous healing Plants*. Southern Book Publishers (Pty)Ltd, Halfway House: 226-228.

Seier, J.V., Mdhluli, M., Dhansay, M.A., Loza, J., Laubscher, R., 2002. *A toxicity study of Sutherlandia leaf powder (Sutherlandia microphylla) consumption*. Final report: April 2002. Medical Research Council of South Africa and National Research Foundation.
www.sa-healthinfo.org/traditionalmeds/firststudy.htm.

Sia, C., 2004. *Spotlight on ethnomedicine: Usability of Sutherlandia frutescens in the treatment of diabetes*. The Review of Diabetic Studies 1, 145-149.

Snyders, J.H., 1965. *Chemical investigation of Sutherlandia microphylla burch*. MSc Thesis, University of the Free State, Bloemfontein.

Swaffar, D.S., 1995. *Combination therapy with 5-fluorouracil and L-canavanine: in-vitro and in-vivo studies*. Anticancer Drugs 6, 586-593.

Tai, J., Cheung, S., Chan, E., Hasman, D., 2004. *In vitro culture studies of Sutherlandia frutescens on human tumor cell lines*. Journal of Ethnopharmacology 93, 9-19.

USP 25–NF 20, *Validation of Compendial Methods Section (1225)*, United States Pharmacopeal Convention, Rockville, Maryland, USA, 2002, p 2256.

Van Wyk, B-E., 2004. *Phyto Nova and wildland plants- an approach to HIV/AIDS*. In: *Martin, V.G., Muir, A. (Eds.), Wilderness and human communities*. Proceedings of the 7th World Wilderness Congress, Port Elizabeth, South Africa. ISBN 1-55591-866-2.

Van Wyk, B-E., Gericke, N., 2000. *Peoples plants: a guide to useful plants of southern Africa*. Briza Publications, Pretoria. ISBN 978 1 875093 19 9.

Van Wyk, B-E., Wink, M., 2004. *Medicinal plants of the world*. Briza Publications, Pretoria. ISBN 1 875093 44 3.

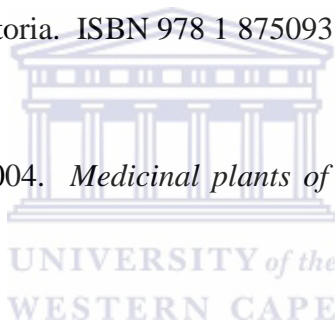

Van Wyk, B-E., Van Oudtshoorn, B., Gericke, N., 1997, 2000. *Medicinal plants of South Africa* [2nd improved impression, 2000]. Briza Publications, Pretoria. ISBN 1 875093 09 5.

Van Wyk, B-E., De Wet, H., Van Heerden, F.R., 2008. *An ethnobotanical survey of medicinal plants in the southeastern Karoo, South Africa*. South African Journal of Botany (In press).

Viljoen, P.T., 1969. *The oxidation of pinitol and partial identification of a triterpene glycoside from Sutherlandia microphylla*. MSc Thesis, University of the Free State, Bloemfontein.

World Health Organization, 1999. WHO monographs on selected medicinal plants. Vol. 1. World Health Organization, Geneva, Switzerland. ISBN 92 4 154517 8.

World Health Organisation (1996), Guidelines for the assessment of herbal medicines, annexure 11, WHO technical report series, no. 863, 178, 179



APPENDIX I



CERTIFICATE OF ANALYSIS

Product Code. : 00019
 Batch No. : 11200
 Product : Sutherlandia frutescens herba pulv.sicc
 Production : September 2006
 Retest date : July 2007
 Expiry date : September 2009

Characteristic	Specification	Result
Plant material	: Sutherlandia frutescens herba	Pass
Content	: Sutherlandia frutescens herba pulv.sicc	Pass
Appearance	: Finely milled light green powder	Pass
Odour & Taste	: Intense bitter taste and odour	Pass
Foreign matter	: <2%	Pass
Moisture	: <10%	5.84%
Thin Layer Chromatography	: Afriplex method	Complies
Microbiology		
Total viable aerobic count	: <10 000 CFU/g	No growth
Yeast & Moulds	: <1000 CFU/g	No growth
E Coli	: Absent	Complies
Staph aureus	: Absent	Complies
Salmonella	: Absent/25g	Complies
Storage		
Storage Conditions	: Closed container, cool (20 - 25°C) and dry conditions	

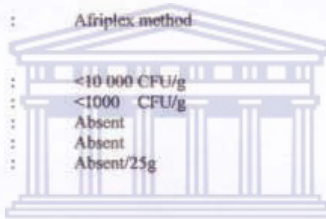

UNIVERSITY of the
 WESTERN CAPE

PAARL, July 2007

Afriplex
 Analytical Department



UNIVERSITY *of the*
WESTERN CAPE



UNIVERSITY *of the*
WESTERN CAPE

Brief introduction of the author:

Ashton Edward Joseph was born in a small town, called Wellington, Western Cape (RSA) and studied at Weltevrede Secondary School until matriculation. He then enrolled for the Bachelor of Pharmacy degree at the University of the Western Cape (UWC) in 2001 and graduated in 2004. Enrolled for the M.Pharm course part-time, in 2008, while working as a full time pharmacist at MediRite Pharmacy Paarl.

