

**STRUCTURAL CONTROLS ON GROUNDWATER
FLOW IN THE CLANWILLIAM AREA**

By

Riyaz Ahmed Nakhwa

Submitted in fulfilment of the requirements for the degree of

Master of Science



In the

Department of Earth Sciences
Faculty of Natural Sciences
University of the Western Cape, Cape Town

Supervisor Prof. Yongxin Xu
Co-supervisor Lixiang Lin
Co-supervisor Prof. Kristine Walraevens

November 2005

DECLARATION

I declare that STRUCTURAL CONTROLS ON GROUNDWATER FLOW IN THE CLANWILLIAM AREA is my own work, that it has not been submitted for any degree or examination in any other tertiary institution, and that all the sources I have used or quoted have been indicated and acknowledged by complete references.

NAME: Riyaz Ahmed Nakhwa

SIGNED:



DATE: November 2005

ABSTRACT

STRUCTURAL CONTROLS ON GROUNDWATER FLOW IN THE CLANWILLIAM AREA

R. A. Nakhwa
MSc Thesis
Department of Earth Sciences

Key words:

Geology, fractured rock aquifer, structures, faults, groundwater flow, hydrodynamic contact, flow models, northwest trend, controls, Table Mountain Group, Clanwilliam.

Deformation of the western part of the Table Mountain Group rocks during the Cape Orogeny created a series of folds and associated fractures. The subsequent continental break-up of Gondwana led to the development of large fault systems. These exert a major influence on deep and shallow groundwater flow.



There are 3 main types of structures that are investigated. The geological contacts between hydraulically different lithologies, the primary characteristics of the sediments comprising the main geological units and the secondary structures developed from the tectonic events. These inter-alia include lithological boundaries, bedding and conjugate joints and large faults.

Compartmentalisation of the aquifers by lithological and fault boundaries are the main regional level controls on flow in the study area. Joints are important for local control of flow, but cumulatively exert a regional effect as well. These controls exert a strong 3 dimensional impact on flow patterns within the area.

Geological cross sections and detailed fieldwork combined with the conceptual models proposed are used to determine groundwater flow and the extent of the flow constraints. There is heterogeneity in the fault characteristics whilst there is

consistence in the impermeable aquitards. These effect boundaries at the base of the aquifer, divide the aquifer into upper and lower units and cap the top of the aquifer.

Using water level data, EC and pH an attempt is made to establish patterns created by structures, mainly faults. There appears to be some control of these shown by patterns seen on contour plots of the data. Understanding of the structures can significantly alter the way the available data could be interpreted.

The integration of all available data into the conceptual model provides an effective research tool, which opens up further avenues for new approaches and methods for continued research in this area.



ACKNOWLEDGEMENTS

In November 2003, I came to see Professor Y.Xu with the intention of doing a postgraduate degree. I did not have a steady job, no financial backing, a family to support and had been out of the university environment for 22 years. He showed his faith in me by allowing me to register to do my Masters. The rest is history!

I wish to thank Professor Y.Xu, for never losing faith in me and assisting me in many ways to overcome the numerous challenges that I had to face. I have discovered more than I ever thought I was capable of doing.

My appreciation to VLIR(Flemish Inter University Council), for granting me a scholarship.

A special thanks to the staff of the Department for their help, friendship and advice at all times and for making me feel part of the team.

To Dr S. Adams and Lixiang Lin for always being there with advice and guidance.

The post-graduate students of L60, for their friendship, co-operation and team spirit.

Thanks also for the assistance and co-operation from Parsons & Associates (R.Parsons, L.Flanagan), GEOSS (J.Conrad), DWAF (B.Dyason, M.Smart, R.Peters, J.Wentzel), CGS (L.Chevallier, C.De Beer, J.Viljoen).

Special thanks go to Saifudin Nakhwa, Anthony Duah, Humberto Saeze, Akber Essop, Asgar Khan, and Jaco Nel for their invaluable technical assistance in finalising the thesis.

To C.Barnard for her sterling work in keeping things on track, and her commitment to the students.

Lastly, a special acknowledgement to my family. The encouragement, assistance, support and faith that they showed through these last 2 years kept me going through the difficult times and helped me stay focused on my goal.

Riyaz Nakhwa

Cape Town, 2005

TABLE OF CONTENTS

| | |
|---|-----------|
| TABLE OF CONTENTS..... | VI |
| LIST OF FIGURES | VIII |
| LIST OF TABLES | X |
| CHAPTER 1 INTRODUCTION | 1 |
| 1.1 BACKGROUND AND CONTEXT OF THE STUDY | 1 |
| 1.2 AIMS AND OBJECTIVES..... | 3 |
| 1.3 RESEARCH PROBLEM | 4 |
| 1.4 PREVIOUS STUDIES..... | 5 |
| 1.5 THESIS STRUCTURE..... | 6 |
| CHAPTER 2 LITERATURE REVIEW | 7 |
| 2.1 INTRODUCTION | 7 |
| 2.2 SUMMARY OF LITERATURE REVIEWED | 7 |
| 2.2.1 Structural geology..... | 7 |
| 2.2.2 Regional geology..... | 14 |
| 2.2.3 Hydrogeology..... | 16 |
| CHAPTER 3 METHODOLOGY | 21 |
| 3.1 INTRODUCTION | 21 |
| 3.2 METHODS | 21 |
| 3.2.1 Remote sensing..... | 21 |
| 3.2.2 Field work | 23 |
| 3.2.3 Geological cross sections..... | 24 |
| 3.2.4 Borehole data | 27 |
| 3.2.5 Water data..... | 28 |
| 3.3 AQUIFER CHARACTERISATION AND CONCEPTUAL MODELS | 29 |
| 3.3.1 Aquifer types..... | 29 |
| 3.3.2 Conceptual flow models | 29 |
| 3.3.3 Zones of influence..... | 31 |
| CHAPTER 4 STUDY AREA | 33 |
| 4.1 INTRODUCTION | 33 |
| 4.2 PHYSIOGRAPHY..... | 33 |
| 4.2.1 Climate | 33 |
| 4.2.2 Surface drainage | 35 |
| 4.2.3 Geomorphology..... | 38 |
| 4.3 GEOLOGY | 41 |
| 4.3.1 Stratigraphy..... | 42 |
| 4.3.2 Structures | 50 |
| 4.4 HYDROGEOLOGY | 56 |
| 4.4.1 Aquifers | 56 |
| 4.4.2 Groundwater flow | 58 |
| 4.4.3 Hydrochemistry..... | 77 |
| CHAPTER 5 ASSESSING CONTROLS ON GROUNDWATER FLOW | 79 |

| | | |
|---|---|------------|
| 5.1 | INTRODUCTION | 79 |
| 5.2 | STRUCTURAL EVIDENCE..... | 79 |
| 5.2.1 | <i>Faults</i> | 79 |
| 5.2.2 | <i>Joints and bedding planes</i> | 83 |
| 5.2.3 | <i>Lithological contacts</i> | 86 |
| 5.2.4 | <i>Rietfontein Diamond drill hole</i> | 87 |
| 5.3 | HYDROGEOLOGICAL EVIDENCE | 89 |
| 5.3.1 | <i>Water level</i> | 89 |
| 5.3.2 | <i>Water chemistry</i> | 94 |
| 5.3.3 | <i>Springs and wetlands</i> | 98 |
| 5.4 | FLOW CONCEPTUALISATION | 99 |
| CHAPTER 6 CONCLUSIONS AND RECOMMENDATIONS..... | | 103 |
| 6.1 | SUMMARY | 103 |
| 6.2 | MANAGEMENT IMPLICATIONS | 105 |
| 6.3 | RECOMMENDATIONS | 107 |
| REFERENCES..... | | 109 |



List of Figures

| | | |
|--------------|--|----|
| Figure 1.1 | The Table Mountain Group and Study area | 1 |
| Figure 2.1 | Heterogeneity in fault zones | 8 |
| Figure 2.2 | Variable permeability in faults | 8 |
| Figure 3.1 | Position of cross sections lines on published geological map | 25 |
| Figure 3.2 | Multiple geological sections | 26 |
| Figure 3.3 | Flow within the faults | 30 |
| Figure 3.4 | Flow between faults | 31 |
| Figure 4.1 | Location of study area in the Table Mountain Group..... | 34 |
| Figure 4.2 | Main drainage features of the area..... | 36 |
| Figure 4.3 | Drainage patterns of the study area | 37 |
| Figure 4.4 | Drainage and fault orientation | 39 |
| Figure 4.5 | Topographic map showing the relief of the area | 40 |
| Figure 4.6 | Multiple sections showing structures | 43 |
| Figure 4.7 | Cape and Karoo Supergroup sequence | 44 |
| Figure 4.8 | Geological cross sections 7&8 | 45 |
| Figure 4.9 | Geological map of Clanwilliam showing main faults | 46 |
| Figure 4.10 | Weathered dolerite dyke/ Aeromagnetic survey..... | 49 |
| Figure 4.11 | Faults and fold structures of the study area | 52 |
| Figure 4.12 | Joint sets in fractured rocks | 53 |
| Figure 4.13 | Numbered main faults of study area..... | 55 |
| Figure 4.14 | Hydrogeological sections A-J..... | 61 |
| Figure 4.15 | Isometric flow sections | 62 |
| Figure 4.16 | Stratigraphic sequence for cross sections | 63 |
| Figure 4.16a | Cross section 1 | 63 |
| Figure 4.16b | Cross section 2 | 64 |
| Figure 4.16c | Cross section 3 | 65 |
| Figure 4.16d | Cross section 4 | 66 |
| Figure 4.16e | Cross section 5 | 68 |
| Figure 4.16f | Cross section 6 | 69 |
| Figure 4.16g | Cross section 7 | 71 |
| Figure 4.16h | Cross section 8 | 73 |
| Figure 4.16i | Cross section 9 | 74 |
| Figure 4.16j | Cross section 10 | 76 |
| Figure 5.1 | Blocky fault breccia / iron& manganese staining..... | 79 |
| Figure 5.2 | Two different fault types in the Cederberg mountains | 80 |
| Figure 5.3 | Fault breccia and shear in fault zone | 81 |
| Figure 5.4 | Open fault with oxidised zone,near Graafwater | 81 |
| Figure 5.5 | Silicified fault breccia, Elands Bay | 82 |
| Figure 5.6 | Bedding and conjugate joints in Nardouw Subgroup | 83 |
| Figure 5.7 | Panorama view of bedding planes in Peninsula Formation..... | 84 |
| Figure 5.8 | Bedding, long and cross joints in Piekenierskloof Formation..... | 84 |

| | | |
|-------------|--|-----|
| Figure 5.9 | Bedding and conjugate joints in Peninsula Formation | 85 |
| Figure 5.10 | Water seeping out of bedding joints in Nardouw Subgroup..... | 86 |
| Figure 5.11 | Contact zone of Klipheuwel Formation..... | 87 |
| Figure 5.12 | Coreboxes 105,88,23,3 showing bedding joints..... | 88 |
| Figure 5.13 | Water level contours for the Secondary aquifer | 91 |
| Figure 5.14 | Water level contours for the Primary sand aquifer..... | 93 |
| Figure 5.15 | EC value contours for the Secondary aquifer | 95 |
| Figure 5.16 | pH value contours for the Secondary aquifer | 97 |
| Figure 5.17 | Mountain top vlei in Cederberg Pass..... | 99 |
| Figure 5.18 | Conceptual flow in bedding and conjugate joints | 100 |
| Figure 5.19 | Inter catchment flow as indicated on cross sections..... | 102 |



List of Tables

| | | |
|-----------|--|----|
| Table 1.1 | Summary of previous work..... | 5 |
| Table 3.1 | 1:50 000 Topographic maps used | 22 |
| Table 3.2 | Aerial photographs of study area | 22 |
| Table 4.1 | Stratigraphic column for the Table Mountain Group..... | 42 |
| Table 4.2 | Major geological units of the study area | 50 |
| Table 4.3 | Dip angles of the fold limbs | 54 |
| Table 4.4 | Some characteristics of the Primary aquifer | 57 |
| Table 5.1 | Brief description of selected core boxes from Rietfontein borehole | 87 |



CHAPTER 1

INTRODUCTION

1.1 BACKGROUND AND CONTEXT OF THE STUDY

The Clanwilliam area lies between 32° 00' S and 32° 45' S and is bounded by 18° 15' E and 19° 00' E in the western part of the country. It is composed of the Precambrian Table Mountain Group (TMG) consisting of sequences of arenites and subordinate argillites overlain by extensive cover of Tertiary to Quaternary sediments. In this area, the TMG overlies the basement Malmesbury shales. It is composed of the Piekenierskloof, Graafwater, Peninsula, Pakhuis and Cederberg Formations and the topmost Nardouw Subgroup. The Sandveld Group of sediments overlies the lower-most formations of the TMG in the western part of the study area whilst the eastern part consists of outcrops of the full sequence of the TMG making up the topographic highs.

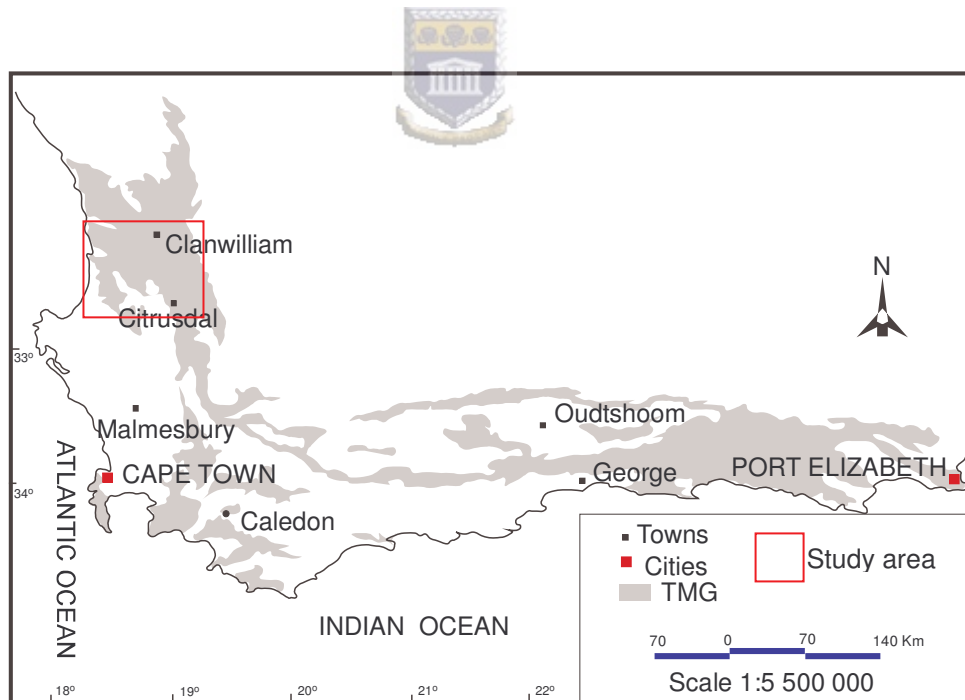

Figure 1.1 Map of the Table Mountain Group showing the study area

Deformation of the area took place during the Cape Orogeny, creating major folds and associated fracturing (DeBeer, 2002). Subsequent continental shifts during the Mesozoic Gondwana break-up produced the major faults with a prominent NW-

SE trend. These events had major impacts on the geology and hydrogeology of the TMG. Dyke swarms with similar NW trends also play an important role.

A fortuitous combination of tectonics, lithology and climate has produced this important aquifer. The high secondary fracture porosity, almost monomineralic lithology, high resistance to erosion and elevated topography, coupled with high precipitation has created an aquifer of enormous magnitude with good quality water. Groundwater flow in the secondary aquifer is a major source of water to the wellfields and production boreholes of the area, as well as to springs and rivers.

The National Water Act (No. 36, 1998) re-arranged the context of water in South Africa. Prior to this Act access to and use of water were the preserve of the landowner (Act No. 54, 1956). The implementation of the NWA depends on the application of resource directed measures (RDM), components of which are the reserve (basic human needs, ecological), classification and the resource quality objective (RQO). For RDM to be effective the resource needs to be accurately established, and this depends to a large degree on the quantification of surface and groundwater. Being hidden, the latter poses unique problems for assessment of recharge and flow, which require satisfactory estimation and conceptualization. Based on the above information resource units (RU) can be assessed in terms of the quantity of water that comes into and goes out of them. Often the estimations are done on a catchment or sub-catchment scale, which may not always apply to the groundwater component as there may be (and often is) appreciable inter-catchment flow. Detailed geological investigation to develop a good understanding of the groundwater dynamics is imperative if the above quantification is to be accurate.

In the context of resource development, it has been acknowledged that the TMG has the potential to be a major source of water to the region and to realize this potential; many uncertainties need to be overcome including an understanding of the occurrence, attributes and dynamics of the TMG aquifer systems (Pieterse & Parsons, 2002). The importance of investigation and understanding of the inter-relations between the various components of the aquifer system in the study area is emphasized in terms of their impact on resource development. The integration of geology, structure, topography, physiography and hydrogeology is necessary for the proper understanding of these systems. It is also noted that one of the key issues to be addressed in a research programme on the TMG aquifer is that of the influence of structural geology on flow dynamics and groundwater occurrence (CCGR, 2000). This study looks at some of these issues in relation to the

Clanwilliam area, which covers parts of the G30, E10, E21 and E24 surface water catchments.

A wide range of studies have been done on the TMG over the years ranging from estimation of water resources and exploitation, to hydrochemistry and associated problems (Pieterse&Parsons, 2002). Although coming into prominence only in the late 1990's there has since been much focus on the TMG aquifers and their characteristics. The area near Cape Town (in the Syntaxis zone) and that of the western part of the TMG has gained importance due to scarcity of water resources and rapid development of irrigation. Despite general studies at a local and catchment scale, there has not been a study directed specifically to the controls on flow in this setting.

1.2 AIMS AND OBJECTIVES

The major North/South trending fold structures and the North-Westerly strike of the faults must exert a great influence on groundwater flow patterns in the major secondary aquifer of the Clanwilliam study area. The dip of the fold limbs and subsequently the bedding plane orientations, and the near vertical normal faults influence the pattern and direction of flow (SRK, 2000) (Titus et al, 2002a). The aim of this study is to identify and investigate these flow constraints regionally and locally. An understanding of shallow and deep flow in terms of structural controls will give a better view of how the recharge/ discharge system works and the implications for water resource determinations.

The main objective is to create a clearer picture of flow in the aquifer. An improved understanding of structures, and how they affect flow at all levels of the aquifer, will be achieved.

The main objectives of this study are:

- The identification, description and evaluation of structures.
- The construction of conceptual models of possible flow paths and dynamics.
- The interpretation of structures and their impact on groundwater flow.

The outcome hoped for is a better understanding of the complexities of the geology and the effects it has on hydrogeological conditions by integrating all the data available into useful concepts of groundwater flow.

1.3 RESEARCH PROBLEM

Topographic highs in the east and coastal lows in the west are interpreted as the main driver of flow as water levels mimic the topography (GEOSS, 2004) (Parsons, 2005). This suggests that flow is from east to west. On examination, this generalization seems not to be the case. Flow is also influenced by other factors, such as the North-Westerly trending fault planes and relief. The depth and orientation of the synclinal structures seems to negate the commonly accepted view of westerly flow directions. Geology and lithology also affect significantly on flow.

The main research problem therefore looks at what the nature of the controls on groundwater flow are in the Clanwilliam area. The controls include structures, which can be faults, bedding and conjugate fractures or geological contacts. These structures can control flow by acting as barriers (low hydraulic conductivity) or as conduits (high hydraulic conductivity). The importance of structures in groundwater studies particularly fractures is well established, but the actual mechanism of control in the TMG has yet to be understood. The behaviour of deep flow in the fold sequences of the study area, and the way in which flow direction is controlled by the main faults has not been addressed adequately. This study attempts to tackle this problem using a multiple approach, which combines structural geology, regional geology and hydrogeology as investigative tools.

The understanding of flow dynamics becomes crucial in the management of water resources. Recharge has to be translated into the flow regime within an aquifer, to understand where and how the water moves in the system. Flow can indicate discharge areas in a system. The quantification of flow into and out of catchments for instance are the main source of data used by managers to strategize, plan and

develop policy on utilization and development. Without flow information, resources can be over or under utilized.

1.4 PREVIOUS STUDIES

Of the studies done on the TMG the focus on structures has been cursory, mainly based on the importance of fractures as good targets for drilling and abstracting groundwater from the sand and hard rock aquifers. They ranged from short, site-specific investigations to large scale, detailed and wide ranging studies of catchments. A large number of reports have been compiled over the years, with some of the more prominent ones briefly summarised in Figure 1.1.

The emphasis in these studies has been on development and quantification of the water resources and the broad management of it. Only the Umvoto/SRK (2000) and the Titus et al (2002) reports deal with structural controls on groundwater, with some very detailed information on the distribution of fractures and faults.

Table 1.1 Summary of previous work

| Year | Title | Study focus | Name |
|------|---|--|----------------------|
| 1983 | Geophysical /geohydrological investigation of ground-water potential between Elands Bay & Lambert's Bay | Assessment of water resources | CSIR |
| 1986 | Investigation of groundwater resources of Eland's Bay area | Developing resource in primary aquifer | Rosewarne,P |
| 1998 | Wadrif groundwater investigation for water supply to Lambert's Bay | Primary aquifer supply | Maclear, |
| 1998 | Olifants/ Doring river basin study | Options for development | BKS/Ninham Shand |
| 2000 | Citrusdal Artesian Groundwater Exploration (CAGE) | Comprehensive study including structural analysis | Umvoto |
| 2002 | Groundwater situation assessment in Olifants Doorn WMA | Integrated water resource management and flow controls | Titus, Adams & Xu |
| 2003 | Level of reserve determination required for the groundwater component-Olifants/ Doring catchment | Catchment groundwater management | Kotze & Xu |
| 2004 | Groundwater reserve determination required for the Sandveld Olifants Doorn WMA | Estimation of resource, quantification of reserves | Geoss |
| 2005 | Assessment of the geohydrology of the Langvlei catchment | Broad generalized study, focus on groundwater RDM of G30 catchment | DWAF, (Nel,J) |
| 2005 | Groundwater RDM in the E10 catchment | Estimating RDM, application of principles to study area | Parsons & Associates |

1.5 THESIS STRUCTURE

The approach adopted for this study included a desktop review of general reports on the TMG, and then of work done specifically on the study area. This included data collection and discussions with stakeholders, in both government and the private sector. Fieldwork was carried out to complement desktop data, to further conceptualise the study area and verify the research problem and to test ideas. The analysis of data and construction of geological sections and hydrogeological maps were used to develop the conceptual model and the hypothesis. This was followed by the compilation of all the components of the study into a final document.

The following is an outline of the thesis showing its structure and content.

Following the introduction is a review chapter of literature related to the study, both of general geological and hydrogeological import. TMG research work was covered and then study area specific literature was considered.

The methodology adopted for the study is explained in terms of methods used, aquifer characterization and development of conceptual models. The importance of this characterization is considered in relation to zones of influence, lithological impacts and implications of sub-dividing the aquifer.

A detailed description of the study area follows where the physiography, geology, hydrogeology and hydrochemistry are discussed. The nature of the above themes is inter-connected, has an interactive relationship, and is explored within the context of the main topic.

In the next chapter, an assessment of the controls on groundwater flow is carried out looking at the facts presented in the context of the geology and hydrogeology. This collates all the evidence in support of the proposed models and concepts and tries to validate the assumptions.

The final chapter is the conclusion and recommendations for future work. The main conclusions that are developed from all the methods applied and the literature and fieldwork covered are listed to assess the value of the research and opportunities created for further investigation.

CHAPTER 2

REVIEW

LITERATURE

2.1 INTRODUCTION

Structures as hydrodynamic contacts impact on the groundwater flow pattern of an aquifer. They could act as hydraulic conductors or as barriers to flow relative to shallow and deep flow. The importance of fractures (joints and faults) is recognized universally, yet there is still much more research needed in terms of understanding the nature and behaviour of these features. Literature was reviewed according to the topics of structure, geology and hydrogeology. Structural geology focused on fractures generally and to studies in the TMG and Clanwilliam area specifically. Work done on the regional geology by local authors was used in order to understand the geological history of the area. The hydrogeology of aquifer systems in general, with a focus on the TMG was reviewed. The chemistry, flow rate, water levels and hydraulic head which are often used as tools to investigate the nature of the faults and geological structures were also investigated and discussed.

2.2 SUMMARY OF LITERATURE REVIEWED

2.2.1 Structural geology

The major structural features impacting on groundwater are fractures and folds. Fractures are subdivided into joints, fissures and faults and are formed by brittle fracturing of rocks (Roberts, 1982). Folds are produced by ductile deformation, and the extent of this deformation reflects on the magnitude of the features formed i.e. synclines and anticlines. The identification of these effects of deformation is used to select targets for groundwater exploitation, and include major fault zones, fold hinges and joint sets. DeBeer (2002) recommended that siting of boreholes be done with detailed consideration of the lithological and structural setting. The

importance of defining boundaries and internal structures of the TMG, especially as they relate to principle hydraulic structures and local and regional patterns of fracture patterns was acknowledged by Hartnady & Hay (2002). They were able in detailed studies in the Citrusdal area to recognize the close relationship between the North/ South fold pattern with the NW/ SE fault system dominant in the area. They also identified and named 5 main joint sets and fault traces and 4 mega-fault systems with associated splays, and described the percolating network of dense interconnected fractures. There is an allusion to 3D fracture models but these are not described or discussed in any detail, but a DEM of surface features is developed instead. Hartnady and Hay (2002) go on to explain that the 3 main fracture components in the TMG are bedding, joints and faults. The generalized grouping of structures required more detailed investigation and hence the present study explored the characteristics of individual faults and splays that make up the mega structures. The term hydrotects was introduced and has been adopted by some to explain structural control of large scale fluid flow/ storage. It is defined as “a major tectonic feature characterized by permeability significantly greater than surrounding country rock matrix” (Umvoto/ SRK, 2000). This explanation fails to consider that these same features could have reduced permeability due to sealing, or that the zone of fracture could be heterogeneous as in Figure 2.1(Evans et al, 1997).

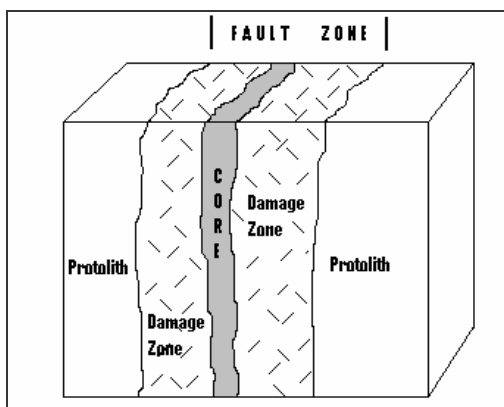

Figure 2.1 Heterogeneity in fault zone

(After Evans et al, 1997).

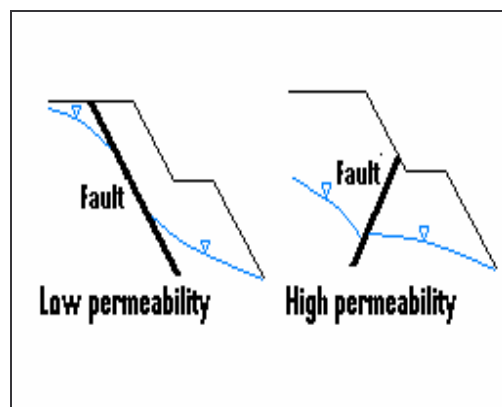
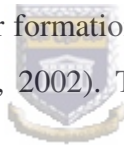

Figure 2.2 Variable permeability in faults

(From Freeze & Cherry, 1979).

Where faults develop sheared and broken zones with little gouge they could be highly permeable, while those that possess thin layers of gouge may be almost impermeable. This is demonstrated in Figure 2.2 where water levels either side of a fault can indicate if it is a low permeability groundwater barrier or a high permeability sub-surface drain (Freeze & Cherry, 1979). In the TMG although the specific targets for exploration boreholes are the fracture zones, fold areas and bedding planes, there is a warning of reduced conductivity where breccia, cement, iron and manganese are present as seals in these structures (Rosewarne & Weaver, 2002). In studies in North America, faults were found to be conduits where gouge was not cemented or act as a barrier where extensive clay or cemented gouge was encountered. Hanging-walls of faults were often more damaged and brecciated with subsequent increased fluid flow, than the foot-walls (Doser, 2004). Groundwater flow and solute transport through fractured rock is highly responsive to the hydraulic anisotropy and heterogeneity that are specific to every major fracture (Khang et al, 2004). Faults can even be considered as combined conduit-barrier systems, both during their formation and after, with reference to the extent of vein filling (Hammond et al, 2002). This would have later hydrogeological implications.



Fault genesis can impact on the way they behave, and reactivation processes can alter this behaviour. The parallel nature of the faults in the TMG is a response to compressional and tensional stresses during the Gondwanan breakup, with resultant splays and displacements (Newton, 1975), (DeBeer 2002). There is some indication that splay, tensional faults display conduit characteristics and compressional faults have decreased permeability. The effects of neotectonics are also important in terms especially of the erosion cycle and seismic activity in the TMG. Hancock et al (1989) investigated the recent joint systems that form in regions subject to uplift and erosion. They noted that these were simple sets of usually vertical extension fractures that propagate within the upper 0.5km of the crust in response to unloading as a result of denudation and uplift. The high mountains of the study area are remnants of a much greater thickness of the TMG, giving some indication of the magnitude of the erosion process and the impact of

unloading and uplift over this huge area. Extension fractures would enhance infiltration and connectivity and contribute to flow. South Africa is a site of pervasive Neotectonic activity accompanied by moderate seismicity. This began in the Miocene and was induced by 3 stress fields in an E, NNE and NW direction. Evidence for late Tertiary to Quaternary activity in the western Cape exist in the seismogenic, mid- crustal left –lateral strike slip movements along NW-trending faults. These are induced by easterly-oriented stresses in the Ceres area (Andreoli et al, 1996). The seismic event of 29th September 1969 and its impact on spring flow is a reminder of the link between groundwater and tectonics. The implications are that existing fault systems may have been reactivated in the recent past and their hydraulic characteristics altered.

In petroleum exploration fault control on reservoir permeability is crucial hence a great deal of focus is placed on understanding fault behaviour. The role of small faults acting as seals and trapping hydrocarbons in compartments has implications for groundwater studies. Knowledge of fault geometry is still modest and interpretation difficult. The development of different pressure regimes either side of sealing faults has led to 2 hypotheses to explain the mechanism. The one is of an impermeable layer caused by gouge/ shale smearing and the other is heavy cementation around a fault plane by calcite, silica or barites. The amount of fault throw is not always an indicator of sealing as both small and large faults can show sealing. Fault geometry was shown to be important for reserve estimation within compartments, where sealed faults would form economic hydrocarbon traps whilst open faults would allow leakage out of compartments (Hardman&Booth, 1991). Although much of this work is in semi to unconsolidated sediments, the techniques and methods used could have wider applications in groundwater flow investigations especially where faults in the TMG act as compartmentalizing boundaries.

In studies carried out in the Netherlands, in an area which is the landward extension of the North Sea oil field region, the detailed investigation of fault controls on groundwater flow were done using a number of simple techniques

(Bense & Van Balen, 2004). The major faults in the North Sea extend into the Netherlands, Belgium and Germany. The studies looked at the behaviour of the water levels in fault bounded areas around open pit mines in the Rhine/ Roer river valleys. Investigation of hydraulic head between faults showed that they act as barriers to flow, whilst relay structures (breaks in the fault plane) act as sites of hydraulic connectivity between blocks. The study looked at the behaviour of groundwater in response to large abstraction rates from open pit coal mines in the area. Boreholes in the area were monitored and hydraulic heads were plotted on contour maps to show flow direction. Due to throw on the faults there was juxtaposition of aquifers against aquitards and clay smearing in fault zones which had the effect of controlling permeability. These faults are in semi –consolidated sediments, with interspersed shale and sand layers.

The similarities to the Clanwilliam study area appears superficial initially, but offset lithologies, steep faults with displacements, compartmentalization of flow in blocks and variable hydraulic heads in adjacent blocks has much in common with the local study area. Although local setting is in fractured, hard quartzite sandstone the methods developed in the Rhine valley can be applied here. Bense & VanBalen (2004) concluded that the distribution of hydraulic head clearly demonstrates the strong impact of faults on groundwater flow, showing compartmentalization between them. Contrasting mean hydraulic heads are separated by faults, and flow is found to be parallel to the faults. Importantly the study considered the hydraulic character of faults, using the calculation of specific resistance to flow perpendicular to the fault or the ratio of the fault width and conductivity.

$$c = w/k$$

Where c is the resistance to flow, w width of the fault and k hydraulic conductivity.

This work focuses on the fault zone directly and tries to quantify the resistance to flow. Conversely if the fault zone has a transmissivity higher than the flanking aquifer, the resultant hydraulic profile will be less significant. Flow across a high transmissivity zone (fault) is limited by the ability of the up- gradient aquifer to supply enough water to maintain the flux, and therefore the gradient in the fault

zone will be lower than in the surrounding aquifer (Bense et al,2003). In the context of the TMG, this aspect has not been investigated satisfactorily in previous studies and an attempt will be made to do so in this work. Bense et al (2003) also recognized in the same research that fault bounded pressure cells were created under some low permeability conditions, but variations occur in areas where sealing causes local highs and other areas where there is no noticeable effect. This illustrates the point that there are patterns of variable properties not only between faults but to some extent along the same fault. These variations are said to be due to fault geometry where throw, orientation, aquifer thickness, clay smear or cataclasis could play a role (Bense et al, 2003).

Groundwater extractions from the large open pit mining in the area have created high hydraulic gradients and it is expected that discontinuing pumping would reduce hydraulic head to a natural flow head. It is possible that these very high gradients could be creating preferential flow whereas lower/ reduced gradients would allow leakage across more permeable parts of the faults and hence alter the flow patterns. These approaches to hydraulic contouring have applications in most environments where sufficient borehole data is available and the geological characteristics well known and the major constraint for the TMG would be the lack of such data and geological understanding.

Having established that faults can form strong barriers to horizontal flow it is important to also recognize that the permeable damage zone adjacent to the fault could be a preferential vertical flow path. Investigation of faults in fractured granites led to the observation that there may be 1 or 2 zones of enhanced permeability between a lower permeability fault core and the protolith (Figure 2.1). This damage zone would act as a conduit for fluid flow, whilst the less permeable fault core is likely to inhibit flow across the fault (Evans et al, 1997). Some core in these zones underwent permeability tests to quantify the effects on flow within each unit i.e. protolith, damage zone and core. Results indicated variations between zones.

Having recognized that a pattern of continuous and interconnected fault systems extending for large distances are a feature of the Clanwilliam area, SRK(2000) suggested that flow paths are controlled by hydraulic connectivity and steep hydraulic gradients of the Cederberg and Olifantsberg mountains in the study area. A primary flux direction to the north and west along the folds in the valleys and mountains was proposed with a secondary flux in a northwesterly direction (along the megafaults) with regional flow from the mountains in the east to the coast. Unfortunately no classification of faults has been made in terms of permeability, to investigate open, sealed or damage zone effects on flow. Thus the “hydrotecs” by definition have not been characterized as “open” or “closed” features nor has vertical permeability bounding them been investigated. The pattern of faults is also more complex than previously assumed as there is limited continuity of the faults in the west with those in the east.

Another important aspect is whether a fault could act as a groundwater divide. If flow is away from the fault on either side, then recharge of the fault is taking place (Bense et al, 2003). However this would be difficult to determine in areas of high topography, as is the case in the Clanwilliam area, or if there is high permeability within a fault. Flow along the fault may be too rapid to impact markedly on water levels either side of the fault. In the context of fault bounded blocks there would be a groundwater divides whether the fault was open or closed, as there could be a discharge out or separation of flow respectively.

Modelling of fractured, faulted and intruded aquifers in Botswana using high resolution air geo-magnetics to map faults and intrusions was done by Wacker et al, 2005. The major role of these structures in influencing flow was investigated and results showed the aquifer was divided into compartments by the faults and intrusive dolerite dykes. This recent work is relevant for possible approaches that could be used in the TMG as a follow up to this study.

In recent work in the study area commissioned by DWAF, the brief was to investigate the role of significant geological structures in groundwater movement

and whether these features are conduits for large distance flow (GEOSS, 2004). Faults were targeted for drilling to ascertain the above. In the report produced from the study, major faults were assigned a transmissivity of 1000-10000 $\text{m}^2 \cdot \text{d}^{-1}$ and a zone width of 50m, whilst the host rock was allocated a T value of 100-300 $\text{m}^2 \cdot \text{d}^{-1}$ (Nel,2004). Recognition of heterogeneity (displacements, connectivity, fill, geometry, aperture) was not made across fault widths nor the possibility of low transmissivity in sealed faults, and any calculations of groundwater flows based only on the above generalizations could be erroneous.

2.2.2 Regional geology

The TMG has a unique geological setting. The Cape Supergroup although deformed, shows great lateral continuity in its lithological character along the almost 1000km length of the Cape Fold Belt. It consists of a succession of sandstones, shales and minor conglomerates unconformably overlying PreCambrian-Cambrian basement (Broquet, 1992). Descriptions of the TMG lithostratigraphy, isopachs, rock genesis and palaeo-environments have been made in detailed work by Rust (1967), but no structural or tectonic explanations were included. The stratigraphic column of the Cape Supergroup was sub-divided into groups and formations by Macey (1998), identifying lithological boundaries and characteristics of individual units. Hydrogeologically the TMG is simplified by lithology into 3 major, fractured sandstone units(aquifers) and these are separated by 2 shale bearing units (aquitards), which act as confining layers to groundwater flow (Kotze&Xu,2003 cited in Umvoto,2000). Rosewarne&Weaver (2002) concur, describing the Group as a 2km thick sedimentary unit consisting of quartzite, arkose, conglomerate and shale in 8 formations. However the Graafwater Formation (1 of the 2 aquitards referred to above) has been recently described as a silt/sand/mudstone or silt/sandstone and is therefore not strictly an aquitard (DeBeer, 2004, pers.com.). This type of classification has important hydrogeological implications for the lower aquifer as the Piekenierskloof, Graafwater and Peninsula Formations can then be grouped together as 1 aquifer in hydraulic contact.

Due to the growing interest in the Clanwilliam area, the Council for Geoscience (CGS) recently undertook a study to remap the geology of the Sandveld, verify faults, map the extent of the sand cover and the sub-divisions of the stratigraphic units. The maps 3218BA Graafwater and 3218BC Redelinghuys were revised from the previous work done by Theron (1986). The map report included the following. The Graafwater formation was reclassified as an aquitard. Ferricrete nodules and lens indicating fluctuating water levels or palaeo-water tables were described in areas near faults and springs. A dolerite dyke was identified at 100m depth in an unnamed borehole, and a possible extension of the Lamberts Bay breccia basalt was intersected in 3 boreholes (unnamed) drilled to the east of the town (Viljoen, 2004, CGS unpublished report). These igneous intrusives have not been investigated for their role in groundwater flow but have been included into the flow scenario in this thesis.

The False Bay Dyke swarm intruding into the lower formations of the TMG is described in detail in the Cape Town area (Day, 1987). Of significance is the orientation of these dykes in a northwest/ southeast direction following the same regional trend of the faults in the study area. It is suggested that there may be a link with the dykes of the Clanwilliam area found under the Quaternary sand cover of the Sandveld. They are not seen where there is no sand cover to the east. It appears that these dykes stop at the Peninsula formation possibly due to its great thickness here (DeBeer, 2002). The Tankwa dyke in the extreme east of the study area although also trending northwest, is of Karoo age and intersects through the TMG to outcrop in the Nardouw sub-group. Once again the hydraulic impact of these dyke intrusives has not been assessed in any detail.

A deep core borehole was drilled to 800m near the town of Graafwater. This is the deepest borehole in the study area and was commissioned and drilled by DWAF, being logged in 2002 by the University of the Western Cape. Detailed logs and photographs indicate the nature of the Piekenierskloof formation and basement

Malmesbury group intersected in the hole (Titus et al, 2002b). The borehole information was used to support the deep flow conceptualization.

2.2.3 Hydrogeology

The large extent of the TMG required investigation as a potential major water source. In order for this to be done all its attributes and the dynamics of its systems need to be understood. The flow concept needs to recognize possible differences in dynamics and paths in specific geographic areas and domains. A holistic approach was adopted in compiling work done on the TMG in the areas of exploration, resource evaluation and management (Pieterse & Parsons, 2002). This approach combined relevant information from a variety of specialists in different fields into one manual. This document has become the handbook of the TMG.



Two hydrogeological domains are identified in the TMG, the inter-montane and the coastal. The former has deep groundwater flow, hot springs, high potential, high recharge, visible targets, artesian flow and good quality water. The latter has shallow flow, cold springs, sand cover making targets difficult, and wave cut platforms and potential saline intrusion and lower quality of water (Rosewarne, 2002). The Clanwilliam study area falls into both of these domains, with the Cederberg Mountains in the east and the Sandveld coastland in the west. The characterization on the above basis is rather generalized but affords a useful starting point. Study area specific information relating to structures, geology and mechanism of flow need to be included as they do not appear in domain descriptors.

No comprehensive recharge investigation has been done of the TMG and because recharge is driven by single/ multiple events and not averages, no single method for recharge can be adequate. The use of direct groundwater measurement of

springs and river flow is proposed, but evapo-transpiration estimation still remains a difficulty (Parsons, 2002). Topography, outcrops and geological trends need to be considered when estimating recharge since the effects of fault boundaries and flow paths on the distribution of the recharge to groundwater is important.

Due to conceptual and practical difficulties the TMG has not been fully exploited, although deep confined artesian conditions in the Peninsula formation has been a focus for resource appraisal. The role of fold axes, mega-faults, dykes and aquitards as well as fracture density, percolation and connectivity is not wholly understood and makes resource estimation difficult. A proposed conceptual model for the aquifer is one with multiple porosity, is regionally unconfined and has spatially variable storativity (Rosewarne & Weaver, 2002). Several hydrogeological domains exist across the TMG area each with unique conceptual models and hydrogeological inter-relationships (Umvoto/SRK, 2000). Aquifer boundaries need to be delineated and the groundwater flow system, flow dynamics and parameters qualified and quantified (Kotze&Xu, 2003). The above mentioned points illustrate the multiplicity of components that require integration into conceptual models and the difficulty in applying the models. There needs to be a strong geological basis for any model, requiring a very good understanding of the lithology, structure and their field expression. This approach then draws other disciplines into the model and builds on it.

Seiler&Lindner (1994) proposed a 3D model to depict a division into shallow and deep flow using the 200m mark delimiting the boundary. This was based on the ion exchange of Ca^{2+} increasing and Na^+ decreasing with depth, and the Tritium Zero level. The use of this 3D model has strong merits but the depth limits are problematic in high altitude aquifers such as the TMG and with structures controlling flow. Another method using remote sensing techniques to quantitatively map 3D fold/ fault geometry, fracture density and location was attempted by Harris &Hay (2002). Their method required the use of digital elevation model (DEM), Change Vector Analysis with LandSat and Air Photo Interpretation. The method may be applied to recharge and estimates of runoff

and/or infiltration but while giving a 3D view of mountain areas, its main limitation is in below surface interpolations of deep structural features such as folds and faults. The traditional use of balanced sections could be the basis for this type of work, to make the required depth interpolations.

Isotopes were recommended as exploration and management tools (Talma & Harris, 2002) and could also be used for estimating age, depth of flow and recharge source for groundwater flow in or along faults. Smart & Tredoux, (2002) described the oxidation of iron and development of iron bacteria and sliming of borehole screens. This process could be investigated in fractures and faults where iron staining may indicate oxidation in permeable fault zones during movement of iron rich waters, as seen in the Cederberg mountain faults (section 5.2.1). An in depth and wide-ranging study in the Sandveld carried out by DWAF used a variety of tools to investigate specific issues. Boreholes were drilled targeting the secondary aquifer and faults, a range of water chemistry analyses were done of the borehole samples, geophysical survey of the holes was carried out, as was aerial magnetics over the area. From the data obtained a model was proposed where flow and recharge were estimated using borehole information, water quality, water levels and auguring information (chloride in soil). A slow, poor quality matrix flow and large volume, good quality fault flow was proposed with discharge at springs, the coast and rivers. The main water source was from recharge in the eastern mountains and fault flow to the west, feeding the primary aquifer (Nel, 2005). Although a great deal of data was generated in this study, assimilation and explanation of results in terms of the conceptual models was not done systematically. The data can still be applied to other models to assess what results can be obtained. The present thesis uses some of this data but applies it to a different conceptual model, with different results. This shows that it is not always the quantity of data that is important but rather the quality and interpretation.

In a linked study in the same area (catchment G30) for groundwater RDM determination a suggestion was made of groundwater divides being different to surface catchments. The geological setting plays a more important role in

groundwater occurrence than does topography, and structural features such as fault planes, weathered zones and bedding surfaces largely control groundwater flow. The secondary aquifer is considered significant and having good connectivity with the primary aquifer, based on higher piezometric head in the former. The Jakkals river and Wadrif receive little groundwater, but the Verlorenvlei gets its water from some distance away. Palaeo-valleys along faults with considerable thicknesses of primary aquifers follow a northwesterly trend and are significant water sources (GEOSS, 2004). This study makes a number of assumptions on flow directions and the role of faults but the geological setting, especially the role of aquifers and aquitards, is not fully explored. Although groundwater divides are recognized as differing from surface catchments this is not elaborated on given their significance in terms of estimating the resource for calculating inflow/ outflow in the resource units.

A broad ranging set of maps making up an atlas for the RDM investigation of groundwater in the E10 catchment was compiled by Parsons (2005). This area is adjacent to the G30 catchment of the above study. Topics covered groundwater regions, aquifer types, borehole yields, exploration potential and borehole prospects based mainly on work done by others. A groundwater elevation, depth to water level and flow map was also included as was recharge, development potential and aquifer classification. Flow is suggested to be due to hydraulic connectivity and steep hydraulic gradients created by the Cederberg and Olifantsrivier mountains, creating an east and westward flow to the Olifants river valley and northward along the valley. There is no interchange between groundwater of the G30 and the E10 catchment (Parsons, 2005). The atlas provides generalized information in good graphical representations. No link with subsurface geology is made in the report, nor is there any flow separation according to the known aquifers/ aquitards of the area or the deep underlying synclinal structures. The importance of cross sections has been demonstrated in this thesis study with application to deep flow conceptualization.

The literature that was included in this review was spread over the main topics of structure, geology and hydrogeology. There seems consensus on the dual nature of faults as open or closed, and their importance in flow controls. However there is little work on classifying faults according to their behaviour. Fault permeability is often generalized for a whole area. Mega- faults and connectivity is assumed to control flow from east to west of the study area based on hydraulic differences, with no appreciation of the underlying structures. Water level between faults is demonstrated as a very useful indicator of fault behaviour, and should be used in this way in the local context.



3.1 INTRODUCTION

The research assumptions for the study were as follows.

- Fractured rock aquifers have preferential 3D flow paths, which are controlled by structures such as faults, joints and lithological contacts. The characteristics of these structures, such as permeability of the faults, extent of fractures, connectivity and the nature of geological contacts, are all important in their influence on hydraulic conductivity of the aquifer.
- The geological setting of the study area is fundamental to an understanding of the research problem, and therefore a detailed investigation of the geology was undertaken.



3.2 METHODS

The research design was structured around a number of important methods. The approach to any study begins with an idea of the information requirements and how this can be developed into useful tools to apply to the research problem. The desktop study began with the literature search and developed further with remote sensing data and field work. Balanced cross-sections were constructed and converted into AutoCAD images. Borehole data was obtained from the GWDB and BHDB from the local DWAF office which included water analyses data.

3.2.1 Remote sensing

Maps, aerial photographs and satellite images were used to develop a visual understanding and representation of the study area as a means to understanding its physical attributes.

The 1:250 000 3218 Clanwilliam geological map by Theron&Visser (1973) published by the Council for Geoscience was used for the regional geology. The published 1:50 000 topographic maps from Mapping & Survey (1986, 87, 88) were used as base maps for the study area. The mapped surface geology by Thamm (1988, 1989), Theron (1995) and Viljoen (2003) were manually traced from the original geology sheets onto the topographical base maps at the CGS in Bellville. The relevant maps used are shown in Table 3.1 covering the whole study area. Topography, drainage and elevations are well illustrated at this scale and accurate slope information and geology could be interpolated.

Table 3.1 1:50 000 Topographic maps used

| | | | | | | |
|------------------|------------------|------------|-------------|-----------|------------|--------------|
| MAP | 1 | 2 | 3 | 4 | 5 | 6 |
| REFERENCE | 3218AB | 3218BA | 3218BB | 3219AA | 3218AD | 3218BC |
| NAME | Lamberts Bay | Graafwater | Clanwilliam | Pakhuis | Elands Bay | Redelinghuys |
| MAP | 7 | 8 | 9 | 10 | 11 | |
| REFERENCE | 3218BD | 3219AC | 3218DA | 3218DB | 3219CA | |
| NAME | Oliewensboskraal | Wuppertal | Goergap | Eendekuil | Citrusdal | |

Black&white aerial photographs at a scale of 1:50 000 were used to interpret the geomorphology, geology and structures in 3D with a binocular stereoscope. Faults and fractures were verified using this method and some discrepancies were noticed between the published faults and what was visible on the AP's. This proved a useful tool to select sites for the field work and to identify features not represented on maps, such as vegetation and tonal differences due to changes in geology or hydrology. The change in topography from east to west of the area was visually more apparent in 3D and the significant rugged terrain of the Cederberg Mountains was useful for conceptualizing flow, runoff and discharge zones. The sets of AP's used are shown in Table 3.2.

Table 3.2 Aerial photographs of study area

| STRIP | PHOTO NUMBER | STRIP | PHOTO NUMBER | STRIP | PHOTO NUMBER |
|--------------|---------------------|--------------|---------------------|--------------|---------------------|
| 1 | 0020 – 0035 | 5 | 0181 – 0198 | 9 | 0393 – 0405 |
| 2 | 0040 – 0056 | 6 | 0200 – 0217 | 10 | 0442 – 0453 |
| 3 | 0095 – 0113 | 7 | 0310 – 0328 | 11 | 0489 - 0498 |
| 4 | 0127 - 0144 | 8 | 0365 – 0378 | | |

CITRUSDAL JOB 1073 (sheet 1 of 1)

3.2.2 Field work

This consisted of traverses of the study area to get a better perspective from the ground of what was covered in the literature on the study area. Except for the eastern mountains, access to the area was excellent with good public and gravel roads serving most parts. The roads into the Cederberg were also extensive and allowed access up into the highest areas by vehicle, with only the peaks requiring long hikes.

Borehole sites posed more difficult, with the thick sand making it impossible to access some areas except on foot. Water sampling was done with J. Conrad of Geoss, on his scheduled visits to monitoring boreholes. The results of the analyses including water level, pH, EC and temperature were then made available to update the database information.

Many geological “type” outcrops were visited to verify descriptions of lithological units and to assess orientation of joints, bedding and textures. Examination of outcrops in quarries in Lamberts Bay, Elands Bay and road-fill sites and road-cuttings elsewhere gave some excellent exposures of different types of fractures and close up views of large faults.

The sequences of stratigraphic units of the TMG seen during the traverses in the Cederberg and Lang Berg Mountains provided a good close- up view of the extent of the structural features. Excellent photographs in the field were obtained and assisted in conceptualizing the study area.

Large faults in the field were examined in detail, as were the trends of the joints to verify desktop studies. Excellent exposures in the coastal areas as well as in the Cederberg Mountains near Clanwilliam and Citrusdal, assisted in better understanding features of the TMG. The physiography of the mountain and coastal regions when viewed on the ground provided a different perspective. Relationships between the different components of the study were made more meaningful in the field context.

3.2.3 Geological cross sections

Using the 1:50 000 topographic/geology base maps compiled as above, a number of profiles were selected running normal to the northwest configuration of the study area. To show the below surface distribution of the lithological units, 10 cross sections were constructed to illustrate this. The sections were placed perpendicular to the northwest strike of the folds and faults in order to reduce distortions as much as possible, and to intersect faults and lithological contacts in such a way as to show their true thickness and dips. In all, 10 balanced sections were constructed of varying length with a north-east orientation (Figure 3.1).

Construction was done on graph paper using standard techniques of profile plotting, geological contact marking and projecting dips of lithological units and faults. Interpolation of below surface geology was then done using all available data from the base maps and then the different lithological units were projected and drawn. A set of 4 sections by DeBeer, 2003 (CGS) were used as a reference for continuity during interpolation of the geology between sections. Both the horizontal and vertical scale was maintained at 1:50 000, to remove vertical exaggeration and maintain accuracy. This scale proved very true when dip angles were plotted, and also gave a more realistic view of the contacts and profiles for assessing groundwater flow direction.

Application was made of the AutoCAD program to generate a digital image of the cross sections. The original graph paper drafts were scanned and then loaded onto a PC. All the graph units were then spliced together to form a continuous view of each section. The geology was then digitized manually off the graph images into AutoCAD for each section and the lithological units filled in appropriate colours. The final sections were annotated, and a multiple section view created with the lines aligned as per map position (Figure 3.2). A further step in AutoCAD was the creation of a 3D (isometric) view of the sections by rotation to illustrate the nature of the flow between sections (Figure 4.15).

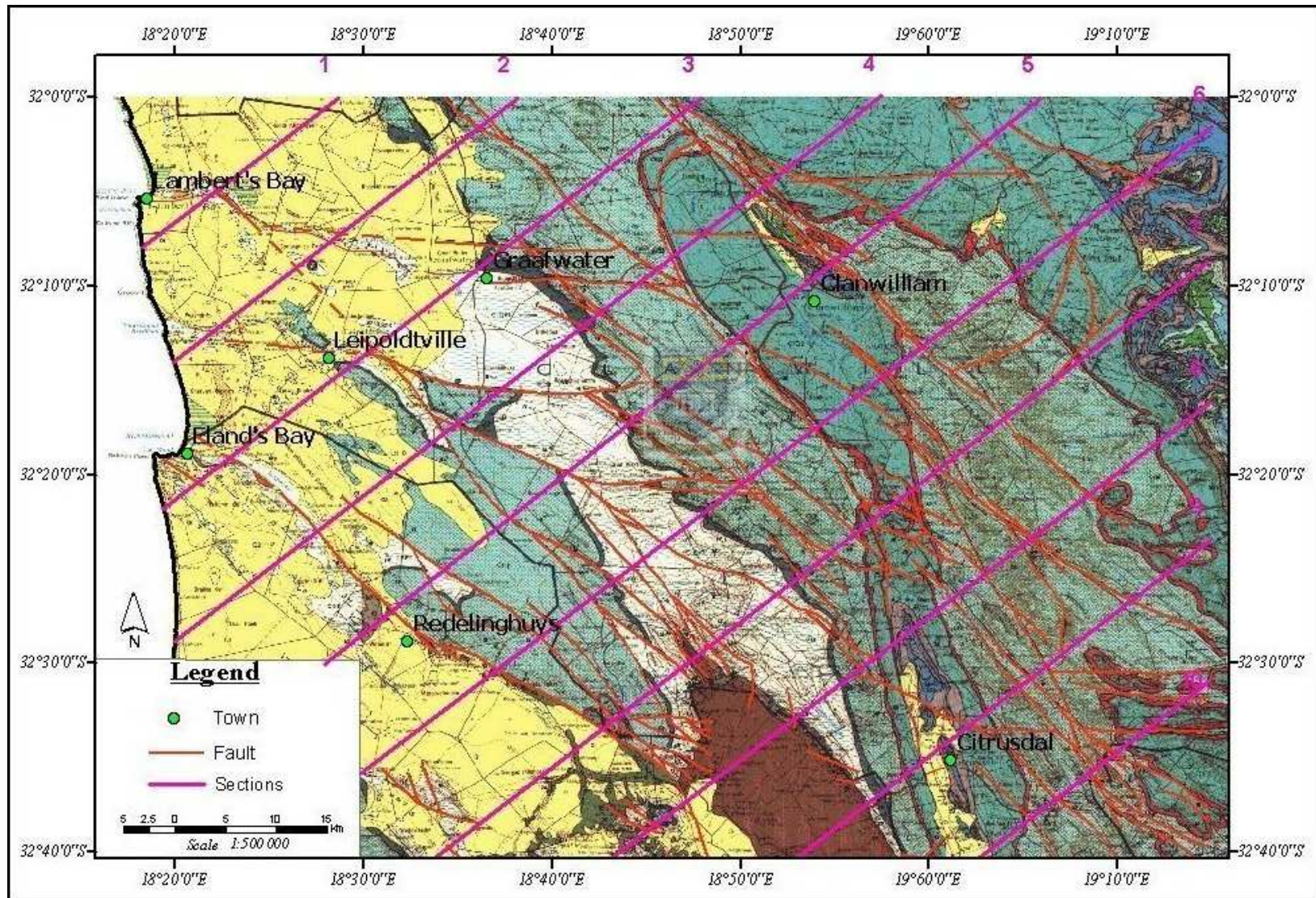

Figure 3.1 Position of cross section lines on geological map (based on published 1:250000 map,3218Clanwilliam,1973,Council For Geoscience)

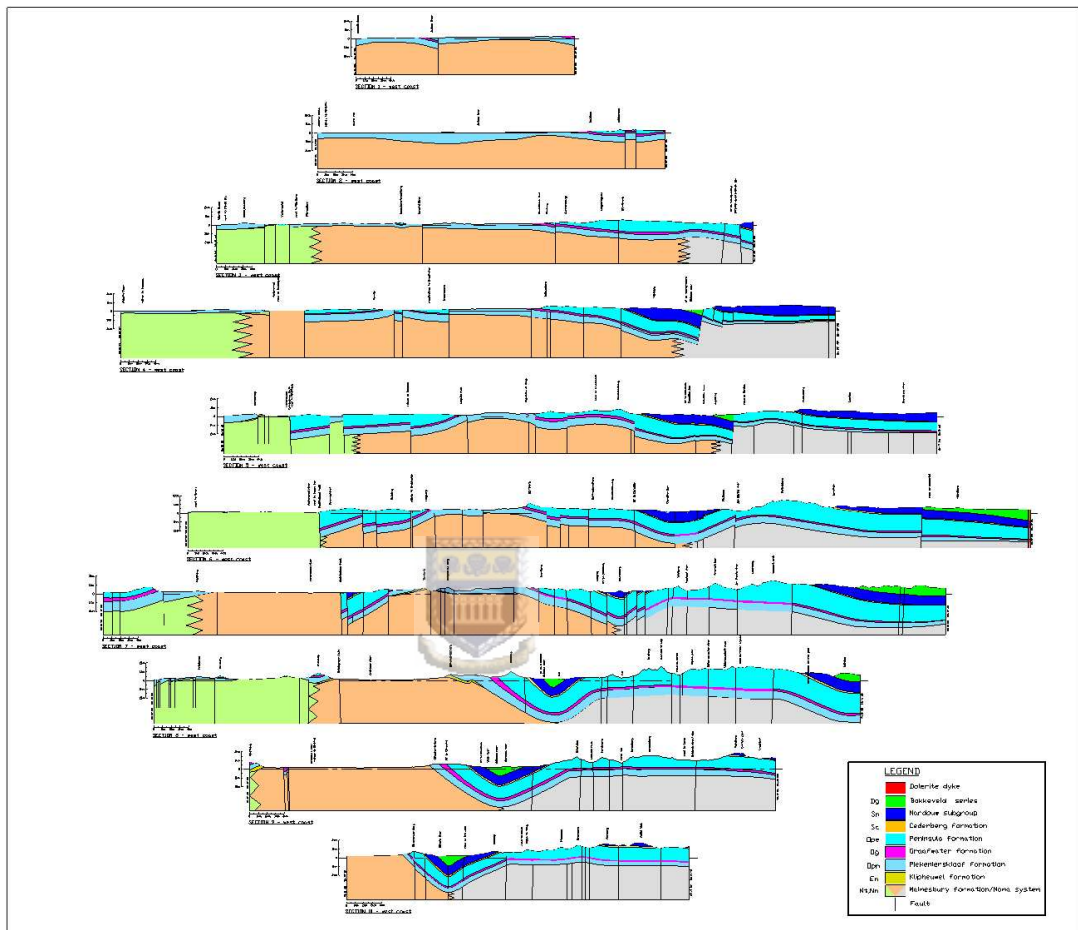

FIGURE 3.2 MULTIPLE GEOLOGICAL SECTIONS (STRUCTURES)

See also Appendix A.

3.2.4 Borehole data

The behaviour of the water below ground level is best shown by the fluctuation of the water table as it responds to recharge or abstraction. The water level of the boreholes indicates responses to surface recharge and in-aquifer transfer by flow mechanisms responding to distant recharge. Borehole data was obtained from the national groundwater data base (NGWDB) and the borehole data base (BHDB) from the regional office of the Department of Water Affairs and Forestry (DWAF) in Bellville (B.Dyason), with a caution that there was some duplication and errors in certain borehole positions. The national database information had to be edited and modified to suit the requirements of this study, from selecting relevant boreholes and compiling time data for each to calculating mean values for selected periods. Water level data was converted from the depth to water to height above sea level.



Other data was obtained from Parsons & Associates and Geoss in Stellenbosch, from work that was done for DWAF in the E10 and G30 catchments respectively. This information incorporated recent hydro census inputs and was modified to remove duplicate holes. For the G30 area there was detailed data on holes drilled for the DWAF (Nel, 2005) study as well as selected hole data from the Geoss (2004) study. In the E10 (Parsons&Associates, 2005) borehole selection was done to sift out duplication, but no separation of holes into primary or secondary aquifers was done. It is common practice for holes to be drilled into the TMG and cased in the sand segment of the hole (BKS&Ninham Shand, (1998) quoted in Parsons & Associates, 2005), and it was therefore assumed that the E10 holes were all in the TMG.

An 800m diamond core-drill borehole done for DWAF on the Rietfontein farm near Graafwater in 2001 was used to get some insight into the deep conditions of the aquifer. It provided an excellent view of the lithology and structures of the Piekernierskloof Formation down to the contact with the basement Malmesbury Formation. The implications of this hole are discussed in chapter 4.

3.2.5 Water data

Water chemistry is a function of the rainfall recharging the aquifer system, the nature of the soil and rock it passes through and the amount of time that it is in the cycle (Mazor, 1997). Differences in the water chemistry can be used to determine its source, the time it has taken to move, depth and direction of flow. Borehole analysis (pH, EC) data was used in conjunction with water level information to relate to the research problem.



Only boreholes that had water level or water chemistry data were used to compile excel tables for this study. Only data from year 2000 onwards was used. Primary and secondary borehole data were separated in order to investigate them independently.

The water chemistry data for these selected boreholes was also modified and sifted from the databases to suit the study needs, with basic pH and EC mainly being used. Certain boreholes had comprehensive chemistry analyses information, and others had isotope data available from the studies in the E10 and G30. This information was not used due to uncertainties in sampling methods used, the large discrepancies between the field and laboratory results, the large spread of the sampling points and catchment specific data sets. This would have made interpretation of the data difficult and unreliable.

3.3 AQUIFER CHARACTERISATION AND CONCEPTUAL MODELS

Understanding the characteristics of the aquifers and conceptualizing the groundwater flow within them helps in the application of methodologies to address the research problem.

3.3.1 Aquifer types

There are two types of aquifer in the study area, namely the unconsolidated primary sand aquifer and the more extensive secondary fractured rock aquifer.

The primary aquifer extends from the coast a short way inland, overlying the lowermost formations of the TMG. The depth of the aquifer varies and it consists of a high permeability mix of sand, shell gravel, clay and minor silcrete. In the Olifants River valley there is an elongated unconsolidated aquifer composed of shallow mainly recent river alluvium.



The secondary TMG aquifer rocks consist of mainly arenites with intercalated argillites, having undergone brittle/ ductile deformation that created folds and major faulting. The deformational structures were investigated in terms of flow regimes. This was based on lithology type, extent and pattern and orientation of folding and fractures, and the position of the aquifers and aquitards within the TMG. These have different influences on groundwater flow. The study tries to understand these influences and the implication for shallow and deep flow within the whole area.

3.3.2 Conceptual flow models

Two models were proposed to try to explain the research problem and the nature of the groundwater flow and structures. These conceptual models are explained later in terms of the data available and tested using the evidence from the methods applied.

3.3.2.1 FLOW MODEL A

In this model (Figure 3.3) flow is channeled into an open fault system with permeability orders of magnitude greater than the fractured rock matrix. Flow in the aquifer along joints feed into, and create a hydraulic gradient towards, the fault. There is low hydraulic pressure either side of the fault which increases with distance away from it. In the 3D view flow is along bedding and down conjugate joints, but areas near the faults flow laterally into the open fracture. Since the faults have great length flow will be channeled some distance to discharge zones. This is significant for high water volume transfers from one part of the aquifer to another.

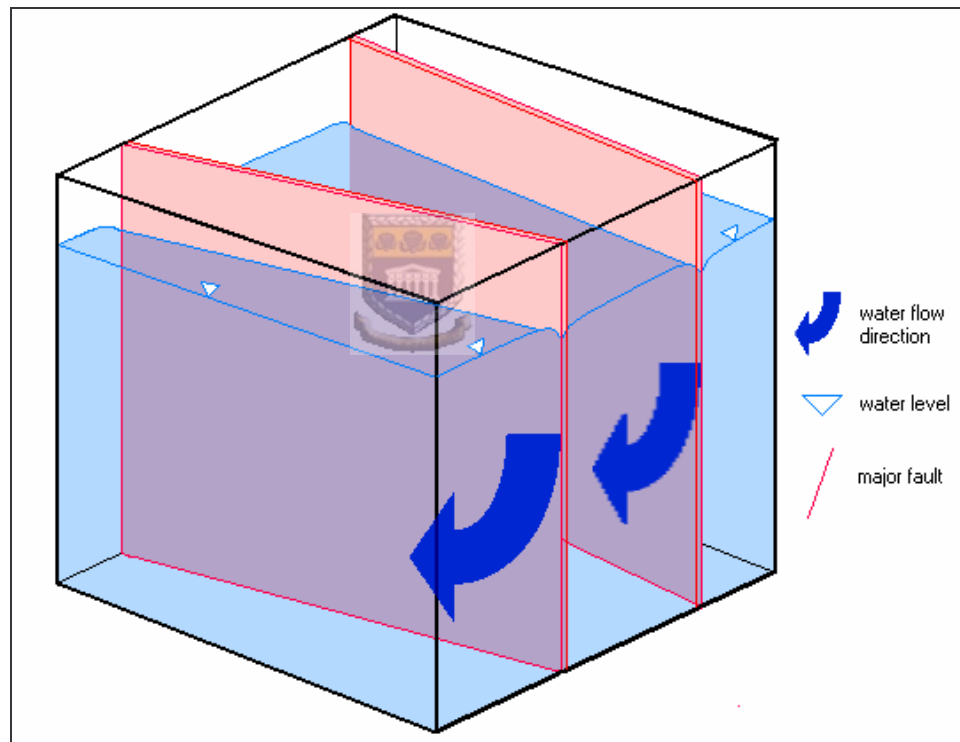

Figure 3.3 Flow within the faults

3.3.2.2 FLOW MODEL B

In the second model (figure 3.4) the faults are closed. Flow is restricted to bedding and conjugates joints and when encountering the fault barrier, will be forced to follow the preferred hydraulic gradient. Permeability is that of the fractures and that of the fault may be orders of magnitude less than the matrix. The faults act as

barriers to flow effectively dividing the aquifer into compartments, independent of each other. These compartments could have different hydrogeological characteristics such as varying chemistry and water levels.

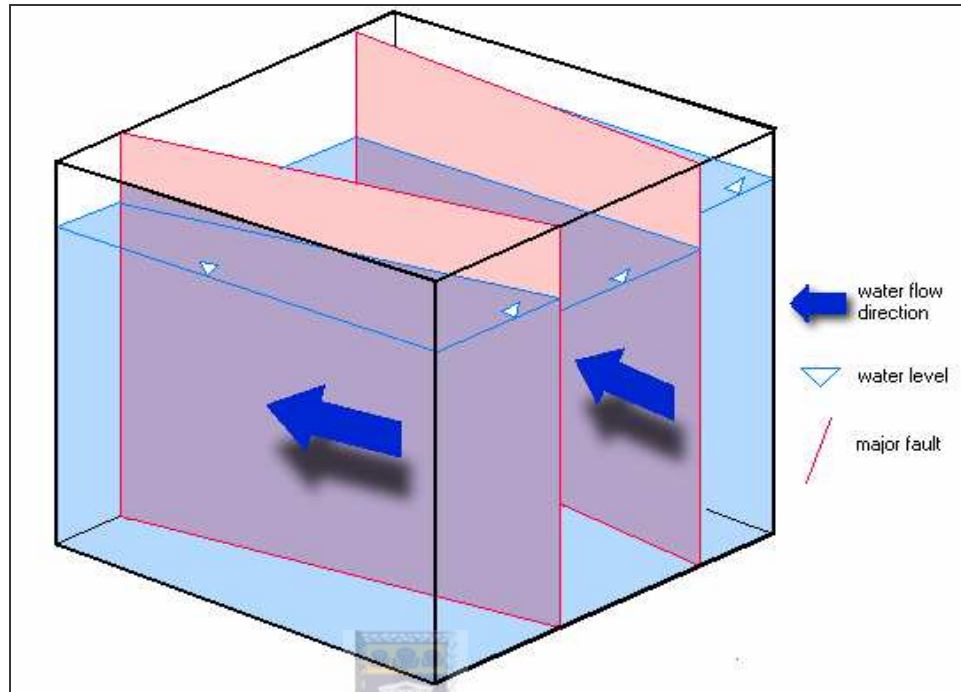

Figure 3.4 Flow between faults

3.3.3 Zones of influence

The nature, extent and outline of the faults from the geological maps, satellite images and aerial photographs suggest a strong control on flow patterns in the TMG aquifer. These NW and EW striking faults intersect each other forming a network of blocks enclosed by either open or closed boundary conditions (Figure 4.13). Each of the major faults was numbered for identification on cross section. This assisted in visualizing the continuity of the different faults between cross-sections. Minor faults and short splays within blocks were ignored for simplicity.

If the blocks form discrete units then they could be investigated for any unique characteristics that could differentiate between them. The theory is that responses will be similar within each, as compared to, adjacent blocks. Factors affecting each of the blocks are recharge, groundwater flow rate, bedding fractures,

chemistry, faults and topography. This could cause further heterogeneity than aquifers show at present.

The method of compartmentalizing the study area would give information on water responses within a block with similar characteristics (see sub-section 4.4.2). Notable differences between the blocks would indicate the dynamics playing out in the individual blocks. These differences would then be explained in terms of the hydrogeology of each unit and the extent and type of structural control.

Some of the limitations to the methods used are briefly mentioned.

-The use of only monitored borehole information in the study area excludes potentially useful information from private boreholes.

-The large gaps in data forces interpolation between points and even the exclusion of some of the data altogether. Huge amounts of data are often not usable due to differences in databases and types of information in them.

-No in-depth analysis of chemistry data was done, although the raw data is available for further processing.

-The limited number of deep diamond drill holes in the study area or elsewhere in the TMG prevent verification of geological cross-section and hydrogeological interpretation.

-A common problem is the inclusion of anomalous values in databases without verifying them, leading to distorted interpretations. A case in point is the EC plots in Figure 5.13.

-Standard sampling of the boreholes and rainfall does not allow for specialized applications. Methods used don't always give the results required for some types of interpretations.

-The large size of the study area also discourages detailed site specific research.

CHAPTER 4

STUDY AREA

4.1 INTRODUCTION

The study area extends from the coast at Eland's Bay up to Lambert's Bay, and then east to Clanwilliam and then south to Citrusdal, between 30°00'S and 32°43'S and 18°15'E and 19°15'E. It covers a diversity of climatic regions, drainage patterns and geomorphology between the coast and the mountainous hinterland. The geology changes from a shallow quaternary sand covered coastal and valley area to a full sequence of deep TMG sandstone and shale units in the elevated areas. This diversity impacts on the hydrogeology of the aquifers, affecting deep and shallow flow patterns and the chemistry of the water within these flow systems (Figure 4.1)

4.2 PHYSIOGRAPHY



There is a close link between topography, climate, drainage and geology. In the study area the influence of elevation on precipitation is marked, as is the impact of geology on drainage. These interactions are important for recharge into the aquifers and resultant flow conditions.

4.2.1 Climate

The region experiences a Mediterranean climate, with hot dry summers and cool wet winters. Annual precipitation is mainly between May and September each year, and ranges from 250mm at the coast to 350mm at the foot of the Swartberg mountains (Nel, 2005). In the Olifantsrivierberg and Swartberg mountains it increases to 550mm, and then decreases to about 360mm in the Olifants River valley. There is another increase eastward to the Cederberg Mountains where it peaks at 1500mm, where snow also contributes to the high precipitation (Parsons, 2005). There is also a general decrease in precipitation from the southern part of

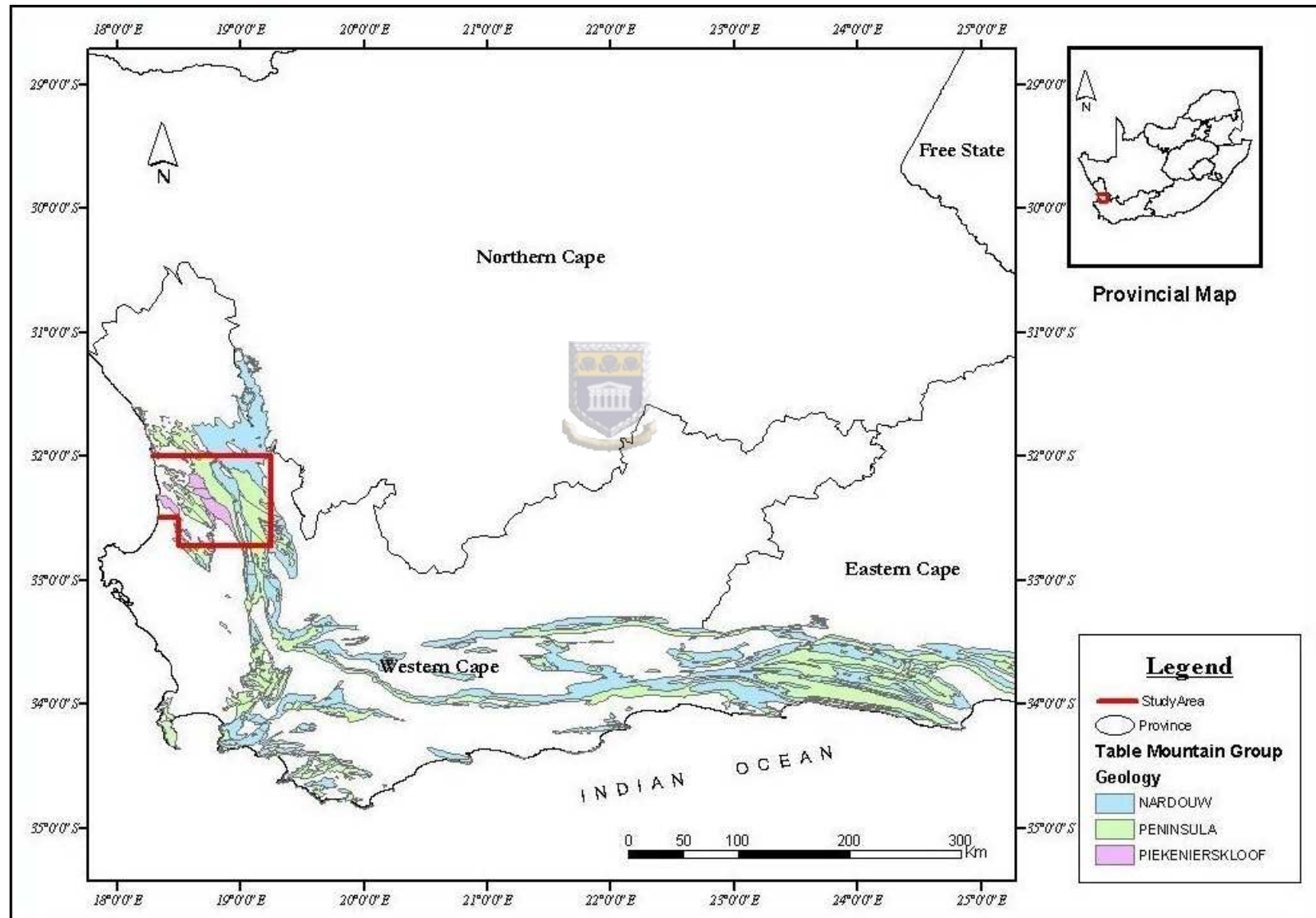

Figure 4.1 Location of study area in the TMG.

the study area towards the northern parts, Citrusdal area having a mean annual precipitation (MAP) of around 420mm whilst that in the Bulshoek dam area being around 280mm. This variability is important in terms of distribution and amount of recharge to the primary and secondary aquifers. It is significant that the highest elevations have the most precipitation due to the orographic nature of the rainfall and these areas make up the main recharge zones. There are 3 rainfall zones, with high rainfall in the eastern mountains, moderate in the central mountains and low in the Olifants River valley and along the coast.

4.2.2 Surface drainage

The major rivers in the eastern part of the area are the Olifants and its tributaries including the Jan Dissels, Dwars, Rondegat and Boskloof (Figure 4.2). These are perennial rivers that have their highest flows in the winter months. The large majority of the rivers and streams are fault controlled and have eroded deep, steep valleys with a NW trend. Groundwater maintains base flow to the perennial rivers in the dry season, mainly from the Peninsula formation rocks. Numerous springs occur, discharging at the contact between the Cederberg shale and Peninsula sandstone and the Bokkeveld shales and Nardouw sandstone. The density of drainage channels is very high, forming angular and trellised patterns and indicating the high runoff from the heavy rainfall in the eastern mountains (Figure 4.3)

There is a contrasting drainage pattern in the western area. The rivers here are isolated and have very few tributaries and there is little surface flow due to the low rainfall and permeable sand cover. The largest river is the Verlorenvlei, which starts in the Piketberg Mountains in the south and drains into the natural lake at Eland's Bay, but it is seasonal and flows only when there are good rains (Visser&Toerien, 1971). The Langvlei river has its source in the Swartberg and flows west past Leipoldville to the coast. It follows a course parallel to the Verlorenvlei and is effectively a string of reed beds, flowing only when there have

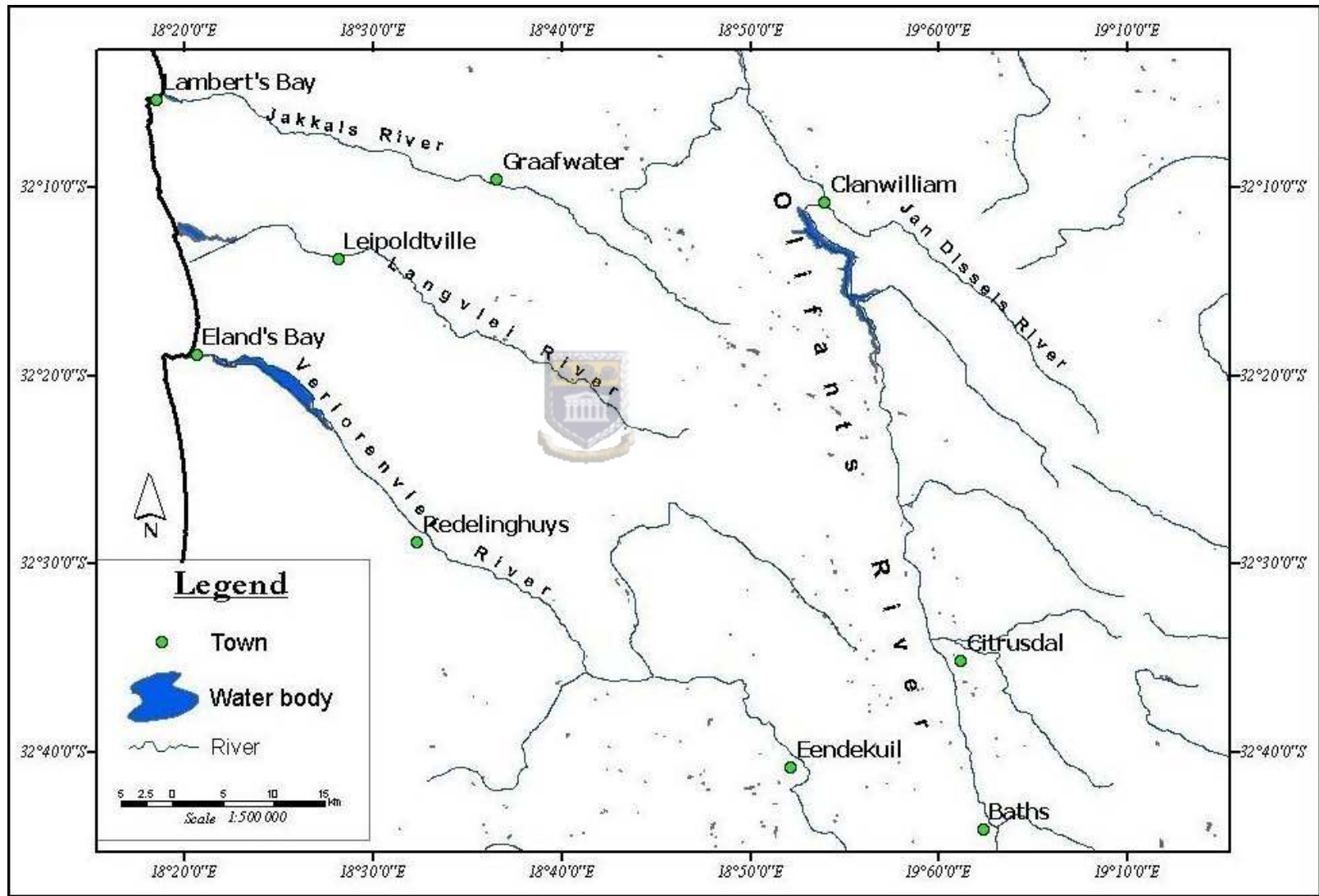

Figure 4.2 Main drainage features of area.

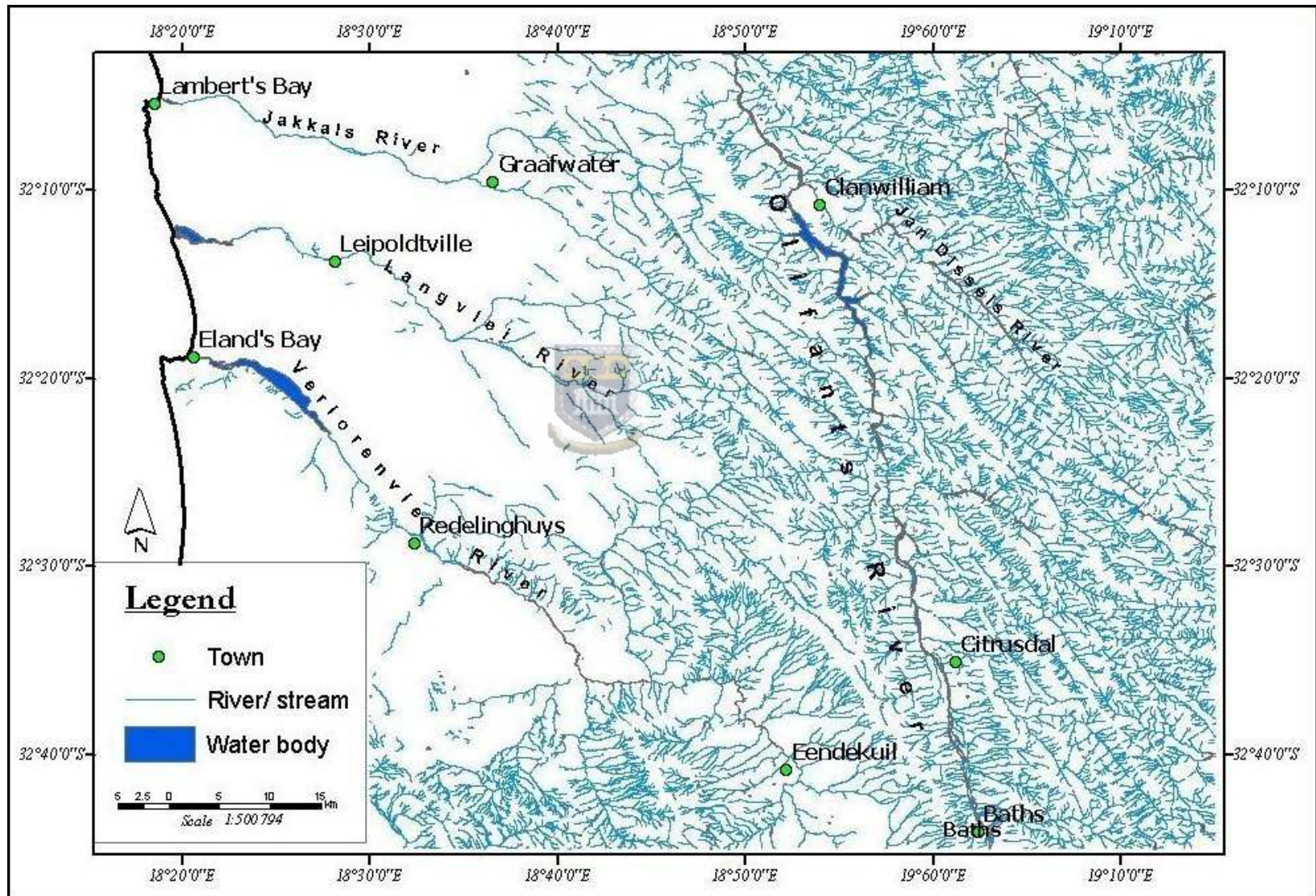

Figure 4.3 Drainage pattern of study area.

been exceptionally heavy rainfalls (Geoss, 2004) and enters the Wadrif pan which itself only fills occasionally. The smallest river is the Jakkals, which starts at the Uitskomsberge and flows seasonally westward to discharge into a vlei at Lambert's Bay. Interestingly, the Verlorenvlei follows the Redelinghuys fault and the Langvlei and Jakkalsvlei appear to be following two east-west faults below the cover sands (Figure 4.4). Springs were common in the area and many have dried up due to over-abstraction for irrigation. Those perennial ones still flowing are found at the contact between the Graafwater and Piekenierskloof Formations. Along the Verlorenvlei River there are 2 springs at the contact between the basement Klipheuwel shale and the Piekenierskloof Formation. Springs at the Wadrif pan have dried up in recent years (Dyason, 2005, pers.com).

4.2.3 Geomorphology

The coastal area consists of a series of erosion surfaces at elevations of 60m, 120m and 240m that are now sand covered stretching to the foothills of the central mountains, indications of past sea-level changes (Nel, 2005). This undulating surface is broken by outcrops of sandstones of the TMG forming elongated hills trending NW with heights above 300m, such as Wolfberg, Olifantsberg and Grootberg. Further inland the Uitskomberg, Swartberg and Olifantsrivierberg mountains range north-westerly and have elevations of 600m, 1200m and 900m respectively and give way to the narrow valley of the Olifants River. This valley is about 5-10 km wide and approximately 90 km in length and has an elevation in the south of 180m and to the north at Bulshoek dam of 60m, a very shallow gradient of 1 in 750 (Figure 4.5).

East of the valley is the steeply rising, significantly larger mountain ranges from north to south, of the Pakhuisberg (1087m), the Krakadouwberge (1800m), the Cederberg(1700m) and the Middelberg (1330m). The northwest trend persists throughout these mountains and the resistant sandstone gives rise to elongated peaks such as Pakhuispiek (1111m), Krakadoupiek (1744m), Sneeuwkop

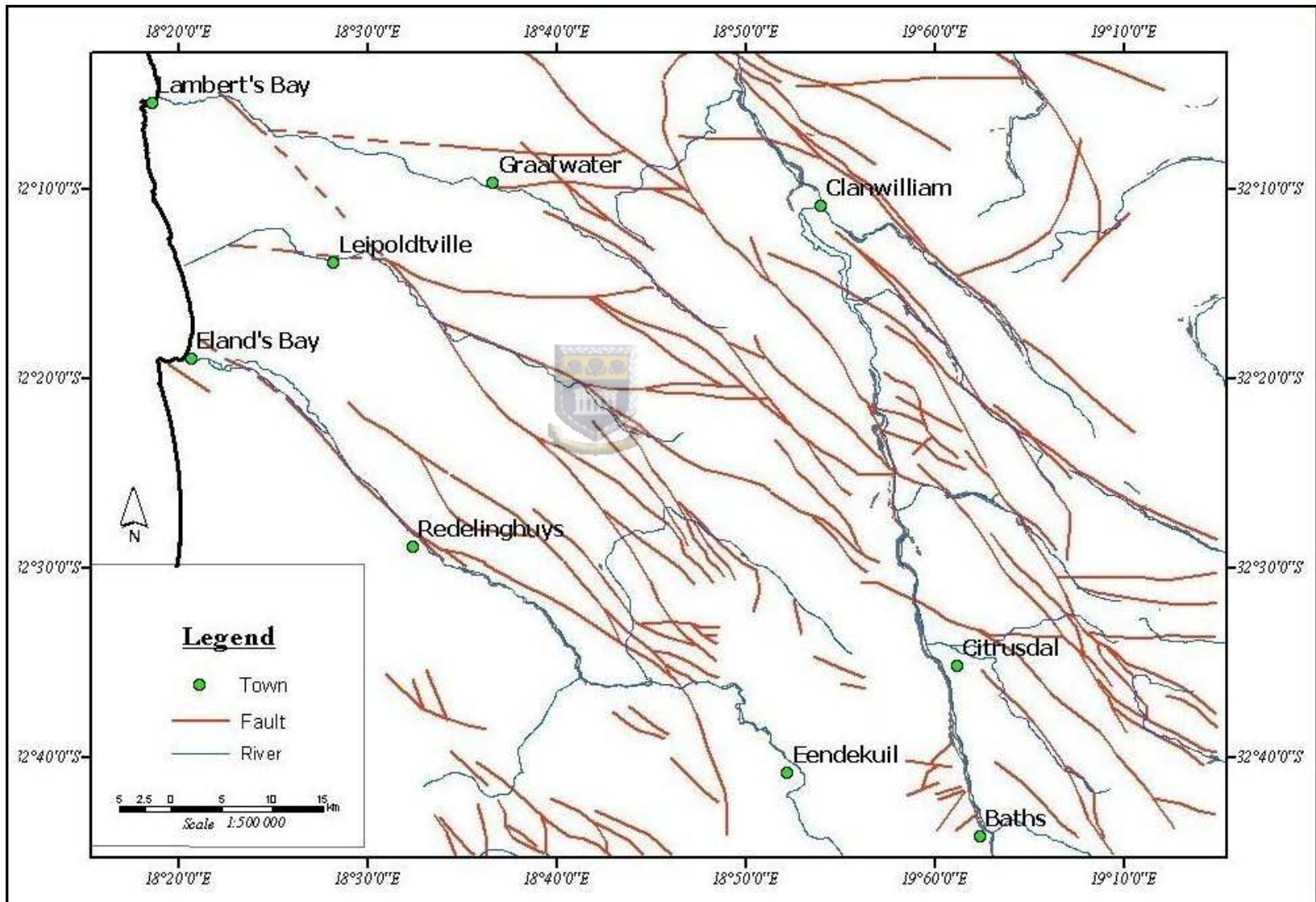

Figure 4.4 Drainage and fault orientation.

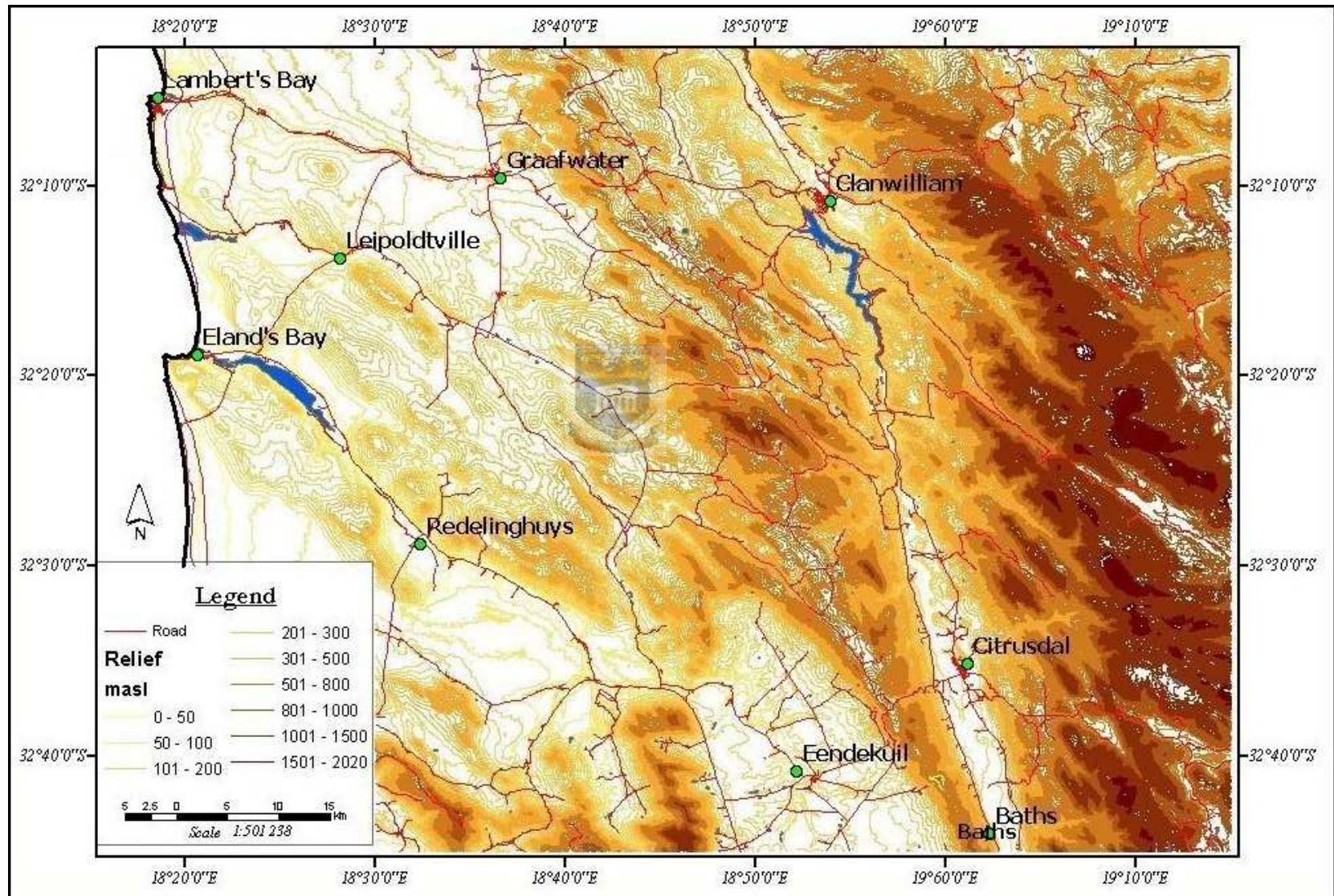

Figure 4.5 Topographic map showing the relief of the aerea.

(1930m), Tafelberg (1969m), Sneeuberg (2026m) and Witberg (1329m). The ranges and peaks are separated by very steep valleys which have thick scree slopes of boulders, sandy soil and sparse vegetation, and almost vertical bare rocky crags near the top. Run-off from these surfaces follows stream channels or infiltrates into the scree and discharges further down slope as interflow.

The large faults that intersect the study area, especially in the eastern part, control the north-west trend of the geomorphic features and the steep river valleys which preferentially follow them. Larger joints trending south-east also act as flow channels and have produced smaller valleys that intersect the larger ones. The valley of the Kromrivier and Breekkransrivier run east/west and each are controlled by similar trending faults, and produce the only easterly oriented ridge with Apollo peak (1699m) and Murraysberg (1541m) being the high points.

Another important feature of the bedded sandstone of the region is the formation of the numerous caves and overhangs, which are thought to be due to differential weathering along bedding joints or due to small lithological changes in the rock. A prominent example of these are the Stadsaal caves in the Cederberg mountains (Boelhouwers, 1999), which are very extensive and could play an important role in controlling runoff, interflow and increasing infiltration. The Wolfberg arch also illustrates the effects of weathering and probably stress release along bedding and conjugate joint planes.

4.3 GEOLOGY

The Cape Supergroup has undergone significant deformation but still shows large lateral continuity in its lithological character along its approximately 1000km length. It consists of a succession of sandstone, shale and minor conglomerate resting unconformably on the basement (Broquet, 1992). The TMG component of the CS is described as a 2km thick sequence of sedimentary rocks from ortho-quartzite to arkose, conglomerate and shale comprising of 8 formations (Rosewarne&Weaver, 2002).

The nature of these litho-stratigraphic units had varied responses to deformation, both during the Cape Supergroup(CS) orogeny and the Gondwana breakup. The predominantly arenaceous layers responded by undergoing brittle fracturing, creating networks of joints. Significantly these factors created the secondary porosity that contributes to the permeability of the aquifer. The softer argillaceous units, mostly shales and phyllites of the Cederberg formation and the Malmesbury basement responded in a ductile manner and absorbed the deformation stresses remaining relatively unchanged.

4.3.1 Stratigraphy

A detailed lithological description of the TMG stratigraphy was compiled by Rust (1967) using outcrop data and extrapolations. Broad groupings showing the constituent units are shown in Table 4.1.

Table 4.1 Stratigraphic column for the TMG (modified from Macey, 1998)

| GROUP | FORMATION | | THICKNESS (m) | AGE |
|-----------------------|-------------------------|-------------|------------------|--|
| TABLE MOUNTAIN | NARDOUW SUBGROUP | RIETVLEI | 150 | SILURIAN 440Ma |
| | | SKURWERBERG | 206 | |
| | | GOUDINI | 120 | |
| | | CEDERBERG | 120 | |
| | | PAKHUIS | 40 | ORDOVICIAN 450Ma 518Ma 520Ma |
| | | PENINSULA | 1550 | |
| | | GRAAFWATER | 150 | |
| | PIEKENIERSKLOOF | 390 | | |

The multiple cross sections showing the geology of the region are shown in Figure 4.6 and a set of 2 long cross sections (7&8) are shown in Figure 4.8.

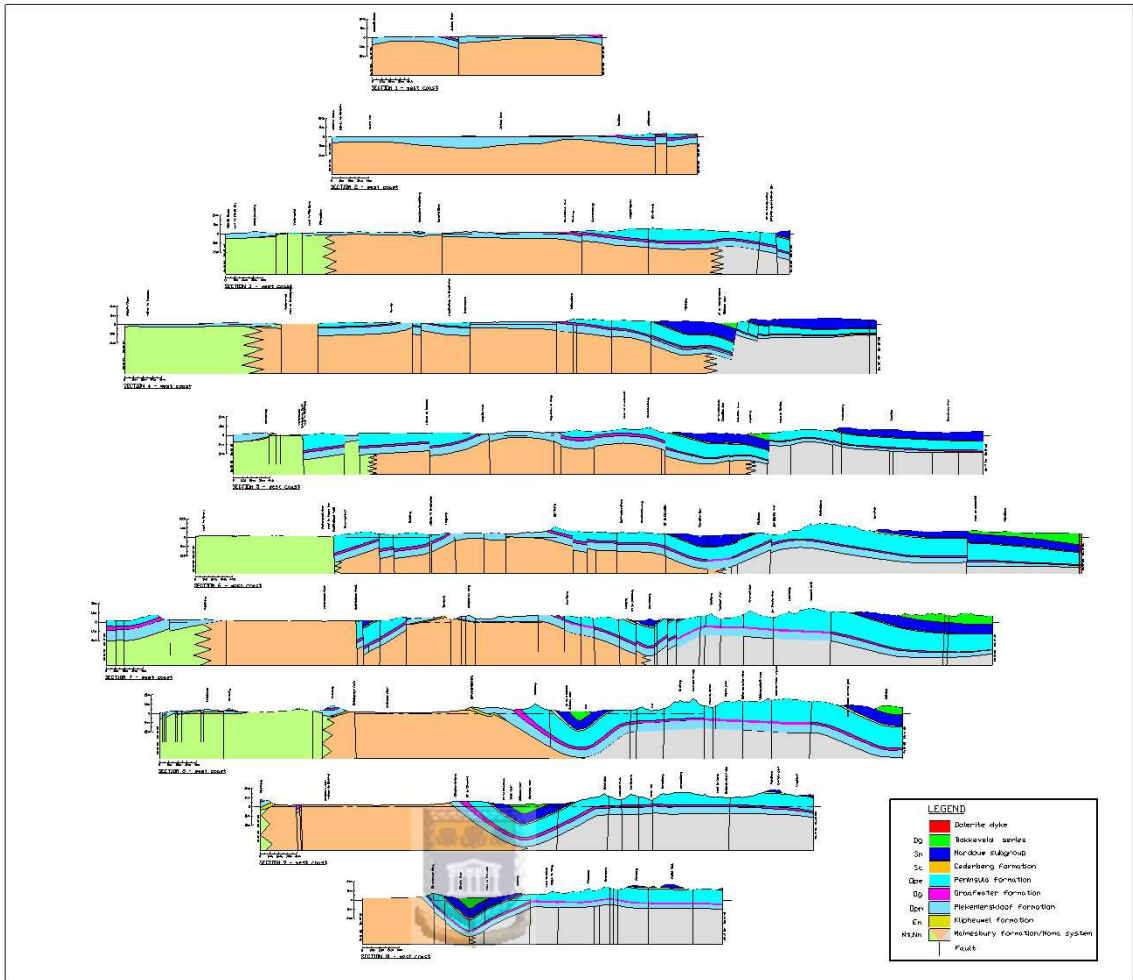

FIGURE 4.6 MULTIPLE SECTIONS SHOWING STRUCTURES

See also Appendix B.

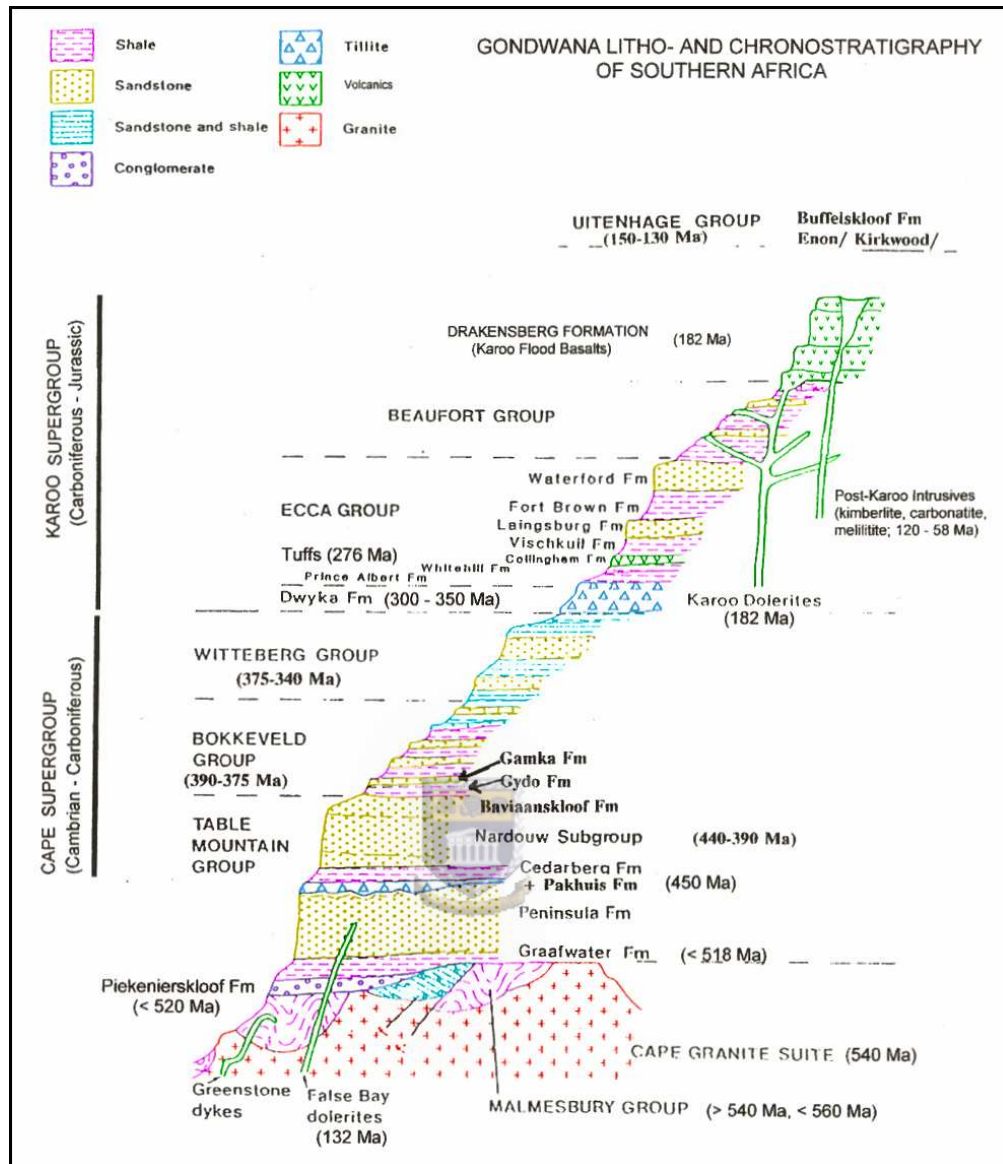

Figure 4.7 Cape and Karoo Supergroup sequence (modified from Reid et al, 1998)

A graphic litho-stratigraphic representation of the relation between the different units is illustrated in Figure 4.7. A geological map of the area is shown in Figure 4.9.

The rocks of the Nama System and Malmesbury Formation form the basement for the overlying TMG. In the western part of the area the Malmesbury shale is exposed in the undulating topography around Eendekuil and forms a narrow tongue to the north. It consists of schist and phyllitic shales.

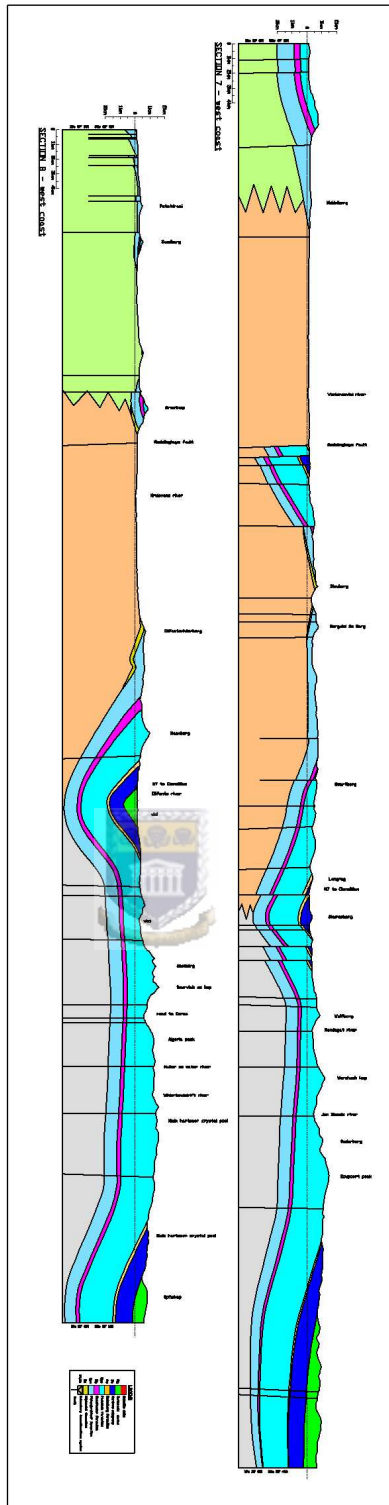

FIGURE 4.8 GEOLOGICAL CROSS-SECTIONS 7 & 8

See also Appendix C.

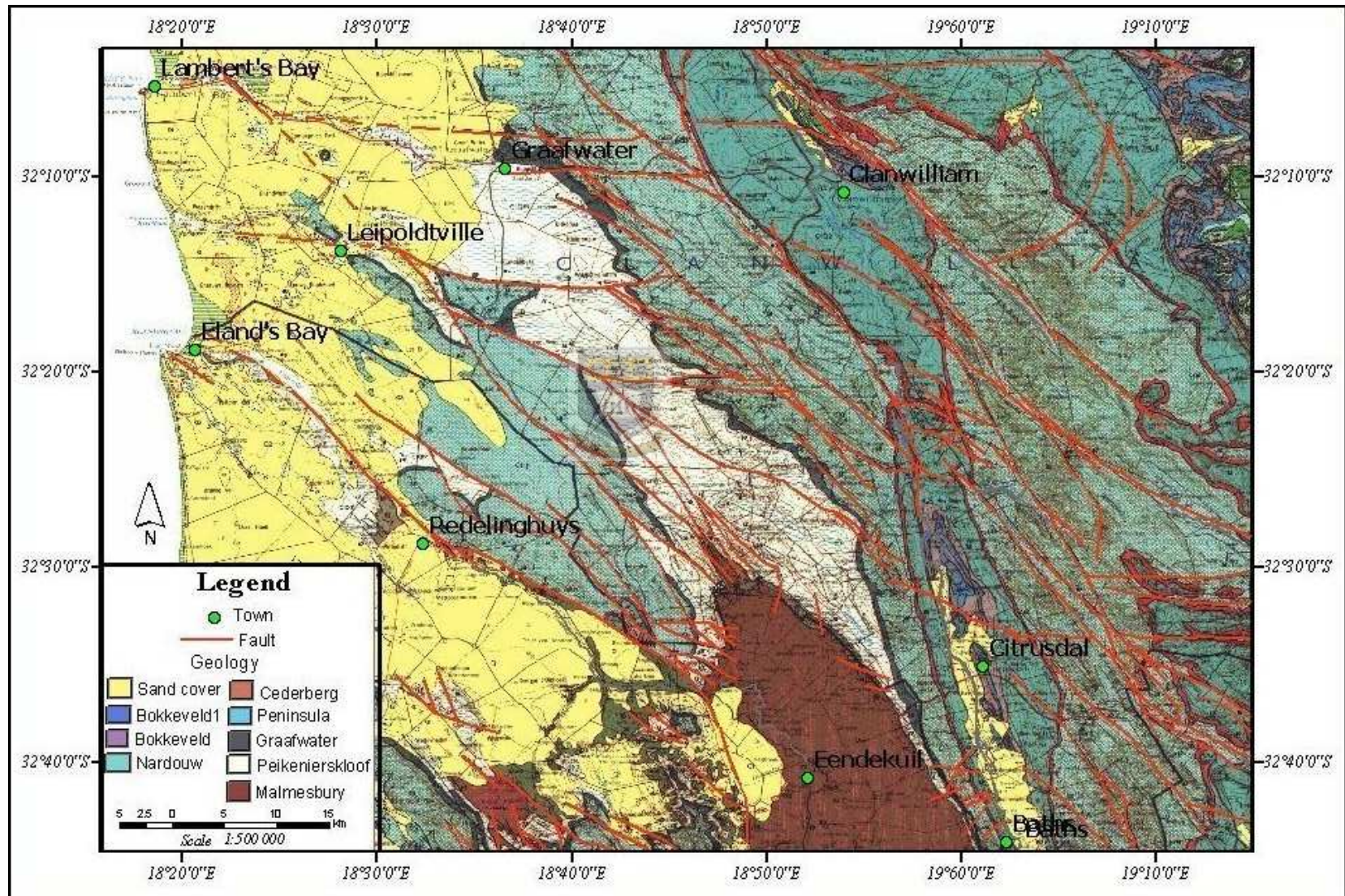

Figure 4.9 Geological map of Clanwilliam showing main faults (based on published 1:250000 map,3218Clanwilliam,1973,Council For Geoscience)

Thin wedge shaped beds of the Klipheuwel Formation are exposed in the foothills of the Bergvlei Se Berg, and also west of the Redelinghuys fault near Elands Bay. It consists of reddish shale grading to silt and conglomerate and is weathered and semi-consolidated in outcrop.

The Piekenierskloof Formation is extensive and consists of the quartzitic coarse sandstone De Hoek member and the conglomeratic Rest member. The thickness of this unit in a diamond drill hole (Titus et al, 2002) at Rietfontein was found to be 750m, but varies elsewhere. Excellent exposures are seen at Lamberts Bay, Elands Bay and along the coastline.

Overlying this is the Graafwater Formation, a purple thin-bedded sandstone grading to siltstone and shale with a variable thickness. The unit has been classified as an aquitard due to the shale Middelpoos member, but it is predominantly silty to sandy in the other members and De Beer, 2004 (pers.comm.) does not classify it as such. The localized aquitard properties, its coarsening grain size eastward and the fractured nature of this formation has led to its inclusion as an aquifer in this study.

The Peninsula is the most prominent and significant formation in terms of thickness, extent and lithology. It consists of clean, coarse, mature quartzite with thicknesses of over 2000m in places. It is thick bedded and often displays small pebble layers. The resistant nature of the quartzite produces the spectacular irregular weathering and high rugged mountains of the TMG.

The Pakhuis tillite is not seen in the study area but the Cederberg Formation is a main marker horizon between the Peninsula Formation and the overlying Nardouw Subgroup rocks. It consists of predominant shale and some siltstone and alters from black when fresh to yellow when weathered. This weathering produces a marked smooth slope with characteristic vegetation and is clearly seen in the Olifants River valley and the Eastern mountains. It varies in thickness between

90m and 120m. This is the main aquitard of the TMG and its consistent occurrence in the area contributes to its importance.

The overlying Nardouw Subgroup is somewhat varied in lithology. The lowermost Goudini member consists of reddish sandstone with intercalations of siltstone and is 50m-80m thick. The Skurweberg member is coarse white sandstone and outcrops in the Clanwilliam area with a variable thickness. The topmost Rietvlei member consists of softer white feldspathic sandstone which gives poor outcrop and is about 100m thick.

The Bokkeveld Group begins with fine sandstone grading into mudstone and forms prominent rounded hills at Clanwilliam and Citrusdal within the down-faulted Olifants River valley.

Intrusive rocks occur in the study area and consist of dolerite dykes and basalt.

There is a dyke which intersects the Nardouw and Bokkeveld Group in the extreme northeast of the study area. It trends NW and is probably of post-Karoo age and part of the dykes found further east. None are seen in the main study area until the coastal area is reached. Here a dyke is exposed at the fish factory in Lamberts Bay. Another weathered dyke in Piekenierskloof sandstone is seen at the municipal quarry outside the town (Figure 4.10a). Geophysical data (Figure 4.10b) indicates a dyke swarm below the sand cover, trending almost EW from Draaihoek through Leipoldville towards the coast (De Beer, 2003), (Nel, 2005), (Viljoen, 2004). This magnetic anomaly seems to have a thin NW set and a broader EW one. Although the former are inferred as fault traces (Nel, 2005), the Lamberts Bay quarry dyke would suggest that the anomalies could be very thin dykes with NW trends similar to that of the faults. The dykes not appearing elsewhere is explained by the thick sequence of TMG rocks forming an impenetrable barrier, causing the dykes to be emplaced below surface (DeBeer, 2005. Pers.comm.). If this is so then there is reason to link these dykes with the False

Bay swarm (Macey, 1998), which also only partially intrude into the lower portion of the TMG (Figure 4.7)



Figure 4.10a Weathered dolerite dyke.

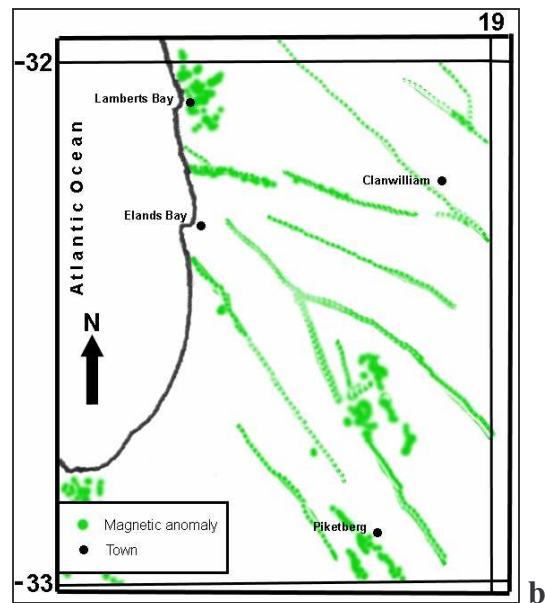

Figure 4.10b Aeromagnetic survey anomalies, (modified from Umvoto/SRK 2000).

The highly weathered basalt breccia also seen in the Lamberts Bay quarry is reflected as an irregular magnetic anomaly cluster around Lamberts bay, indicating that it may be more extensive than the outcrop shows. There may be a link between the EW trending broad anomaly south of Lamberts Bay and the basalt intrusive. The dykes may be linked by the same tectonic events which would explain similarities between fault orientation and dyke directions.

The TMG in the coastal area is covered by unconsolidated material of the Sandveld group. The Varswater formation consists of sand, clay and shelly gravel in a thin band northeast of Elands Bay. The more extensive Springfontein covers the larger part of the area with sandy soil. The Witsand, as the name implies, is mainly calcareous beach sand and occurs in a thin band less than 500m wide along the length of the coast (Table 4.2).

**Table 4.2 Major geological units of the study area
(modified from Viljoen, 2004)**

| AGE | SUPERGROUP | GROUP | FORMATION | LITHOLOGY |
|------------|-------------|-----------------|---------------|------------------------|
| Cenozoic | | | Witsand | Calcareous beach sand |
| | | | Springfontein | Sandy soil |
| | | | Sandveld | Varswater |
| Mesozoic | | | Lamberts bay | Breccia basalt |
| Jurassic | | Karoo | | Dolerite |
| Silurian | Cape | Table Mountain | Nardouw | Thin sandstone |
| Ordovician | | | Cederberg | Shale, siltstone |
| | | | Peninsula | Thick grey sandstone |
| | | | Graafwater | Red sandstone |
| Cambrian | | | | Klipheuwel |
| | Populierbos | Shale,sandstone | | |
| | | | Magrug | Conglomerate,sandstone |
| Namibian | | Malmesbury | Piketberg | Phyllite,greYWacke |

4.3.2 Structures



Structures can be defined for purposes of this study as planar, 2 dimensional features that affect flow rates by reducing hydraulic conductivity across them or increasing it several fold, acting as barriers or conduits to flow.

There are 3 main hydrogeologically significant structures in the TMG that were considered in this study. These can be classed as follows:

- Contacts (geological)
- Primary structures (fore sets, bedding)
- Secondary structures (Orogenic/tectonic – fractures & folds)

The nature of the stratigraphic units and the composition of the lithological units, act as structural controls to flow. The main aquitards are the Malmesbury, Bokkeveld and Cederberg shales which provide hydraulic barriers to movement across them. Some parts of the Graafwater Formation with fine shaly siltstones act as contacts of differential permeability. Where shales contact with the quartzitic

sandstone aquifers they are considered as influencing flow. When the aquifer lies horizontally on the basement shale, this becomes the lower boundary, but where the TMG is folded the same basement now becomes an impermeable boundary on all sides of the syncline or anticline. The Cederberg shale behaves in the same manner. The Bokkeveld Group caps the TMG in the syncline but in the faulted areas (Cross section 5, Figure 4.14 EF) the impermeable boundary is only on one side. There is thus confining conditions created between the Basement shale and the Cederberg, and again between the Cederberg and Bokkeveld in different parts of the TMG (Section 8, 9&10, Figure 4.14 H,I,J).

The role of the intrusives is little known not least because of their concealed position. Based on inferred width and depth, their role in flow control hinges on their characteristics. Weathered dykes have a higher permeability and conductivity than the country rock(Figure 10a), but unaltered dyke may be the opposite. However, the presence of highly fractured contact zones either side of the dykes could provide preferred flow channels that may have higher permeability than the country rock.

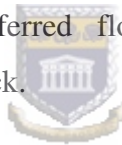

Primary structures are important in the way they influence secondary structures. The depositional environment produced beds in different forms, in shape as well as thickness. The Piekenierskloof Formation sandstones have thinner bedding (0.3-1.5m) with conglomerate, the Graafwater Formation shows facies changes from fine to coarse, with very thin(0.1-0.5m) beds. The Peninsula (1.0-3.0m) and Nardouw (0.3-2.0m) Formations have thick beds with in the case of the latter, intercalations of thin(0.3-0.5m) finer grained material (De Beer,2002, pp11). These dimensions were maintained even after the deformation of the sedimentary units and manifest themselves as the present spacing between bedding joints.

Secondary structures are those resulting from the orogenic event's producing the major folds and joint's and the large faults (Figure 4.11). These features are pervasive throughout the TMG and thus have the greatest effect on flow. The

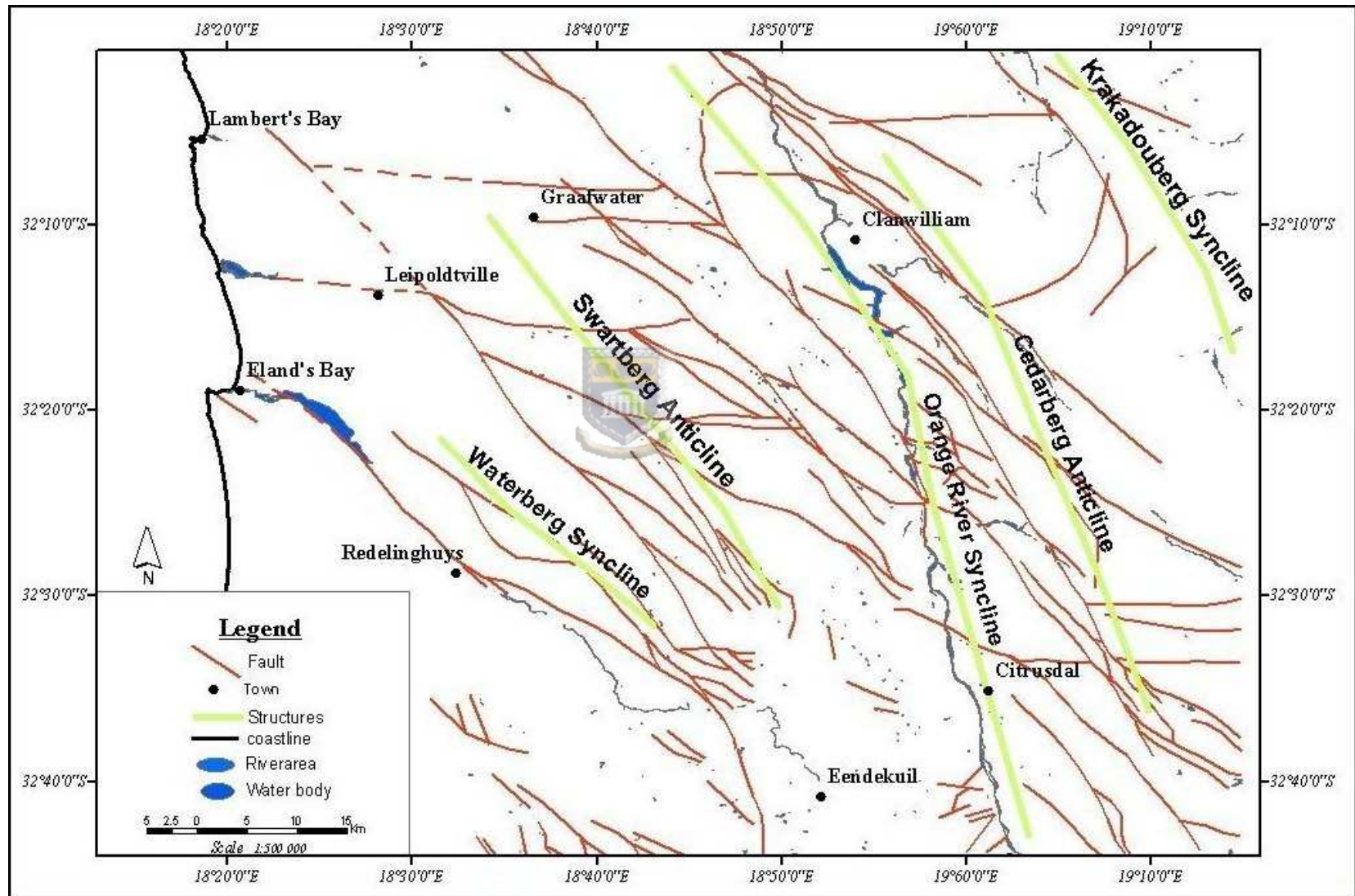

Figure 4.11 Faults and fold structures of the study area.

different responses to deformation and the intensity of this deformation caused differing levels of fracturing of the brittle rock. The type and intensity of fractures then imparted secondary permeability in the form of joints along beds and transverse to folds. Joints occur as well-defined sets along the bedding planes at right angles to the bedding (longitudinal), cross-joints are normal to these, and oblique-joints cut at acute angles to the cross-joints (Figure 4.12a,b). The longitudinal and cross-joints are formed by extension fractures, but near fold hinges longitudinal joints may form conjugate shear fractures (Roberts, 1982). High intensities of joints lead to increased permeability and connectivity, whilst bedding planes allow for preferential flow. From field evidence it appears that the bedding joints are the dominant master joints in the folded TMG (figure 4.12c, d).

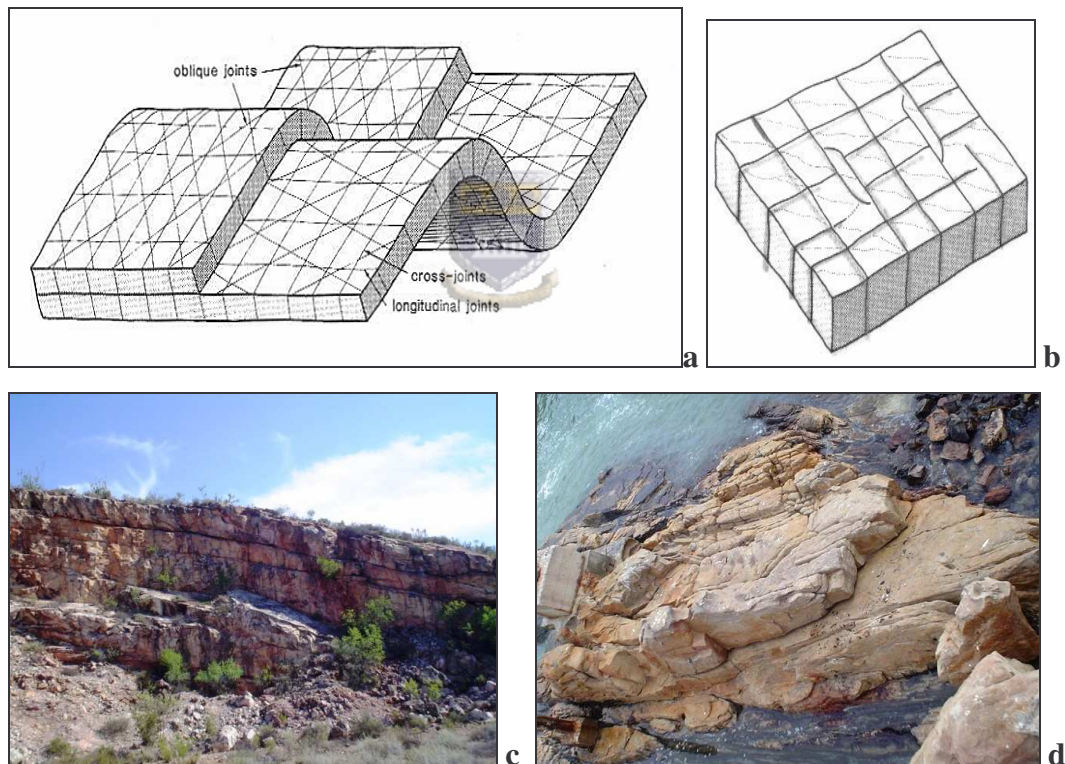

Figure 4 12 a, b, c, d Joint sets in fractured rocks (a, b). Examples of joint patterns in folded Nardouw Subgroup, showing strong bedding joints (c) and in Piekensklouf Formation (d) showing bed, long and cross joints. (a and b from Roberts, 1982).

The structure of the cover rocks in the area within the Northern Domain are dominated by open synclines and parallel minor folds which may show steep dips in places. The northerly trend of the fold axes swings northwest and the flexures

fade north of Clanwilliam where the TMG is horizontal (Visser, 1998). The main fold structures of the study area from west to east consist of the Waterberg syncline, Swartberg Anticline, Olifants River Syncline, Cederberg Anticline and the Krakadouwberg Syncline. These features range from monoclines (Waterberg syncline & Swartberg anticline) to complete synclines (Olifants River syncline) which all trend NW, with the ORS changing to a NS direction in the south as it approaches the Syntaxis area (De Beer, 2002). The dip angles (Table 4.3) for the fold limbs range from 5° to 50°, and are an important control on the gradient of flow of groundwater within the aquifers, and especially for deep flow.

Table 4.3 Dip angles of the fold limbs

| Feature | Waterberg Syncline | Swartberg Anticline | Olifants River Syncline | Cederberg Anticline | Krakadouw Syncline |
|-------------|--------------------|---------------------|-------------------------|---------------------|--------------------|
| Minimum dip | 17° | 08° | 10° | 05° | 12° |
| Maximum dip | 25° | 24° | 50° | 15° | 20° |



Variable deformation created a trough along the ORS in the area below Section 4 and also below Section 8, which receive deep flow from the north and south. The trends of the folds and the faults indicate a strong kinematic relationship (Umvoto/SRK 2000), whilst the deep folds have emplaced the bulk of the aquifers below sea level by as much as 3km (Cross-section 8, Figure 4.8).

In the study area there are approximately 733km of main faults that have a NW trend, 180km with an EW strike and 68km of smaller minor NE oriented ones. The main NW faults (Figure 4.13) have been numbered for identification from 1 through to 9, as have the EW ones. The longest fault is f9 (69km) and f1 (57km) and the shortest one is EW5 (8km), all significant lengths. On the surface the network of faults are discrete, individual narrow traces with good strike continuity, some showing offsets or splays at the ends. Fault f1 has a single splay

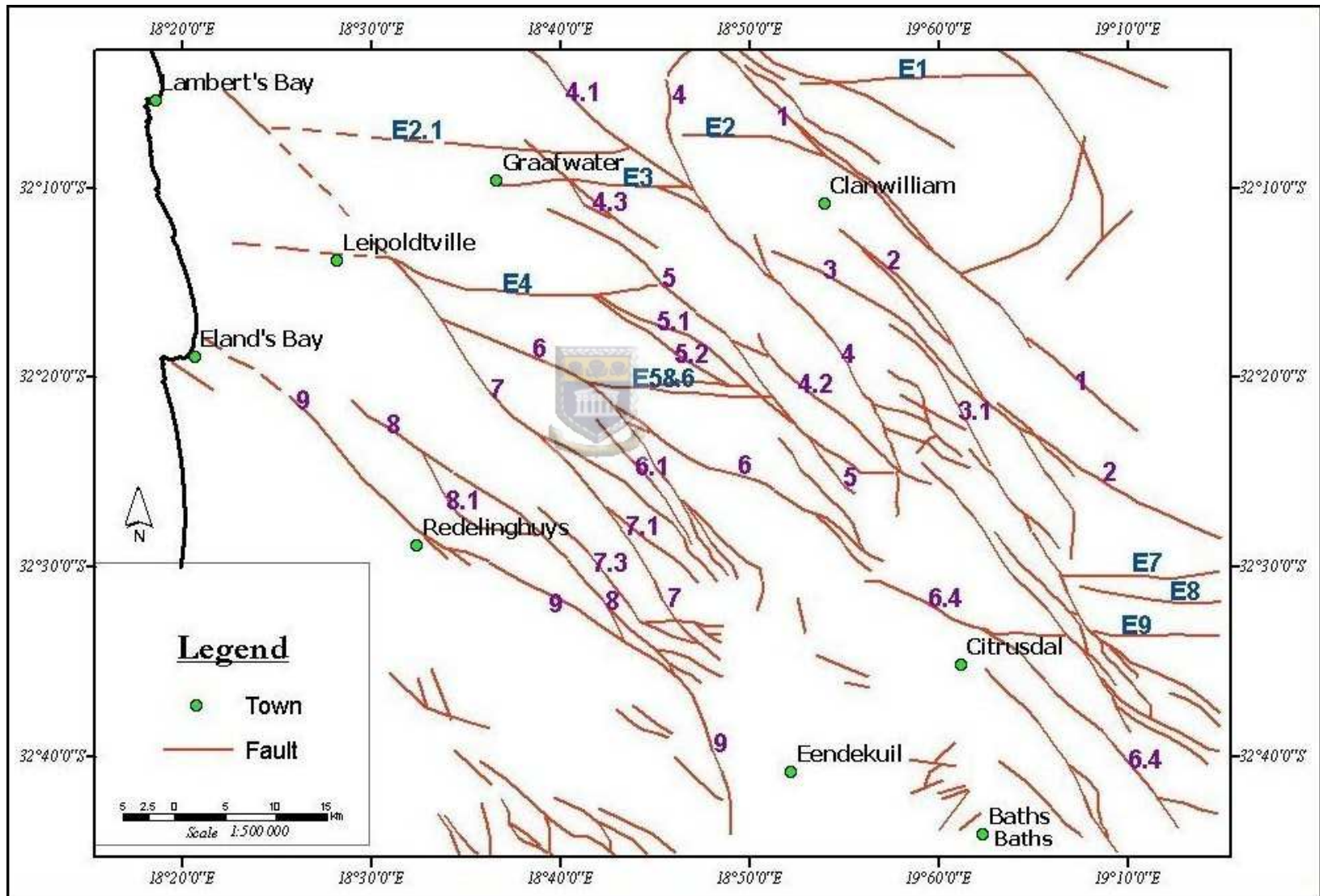

Figure 4.13 Numbered main faults of study area, with northwesterly faults(purple) and easterly faults(blue)

at its northern end into EW2. F2 on the other hand has a splay at its southern end. There is a distinct separation by the ORS of the faults in the east from those in the west. The syncline appears to mark the termination of faults f1, f2, f3, f3.1, f3.2, f3.3 and f6.4 and there appears to be no connection or continuity to the west for these faults. This could possibly be due to the extreme thickness of the TMG here preventing fault propagation westward. Along the western margin of the ORS is the large f4 which has a splay (f4.1) in the north. All the faults on the west side show large splays, for instance f5 into f5.1 in the north, and f6 into f6.1 in the south. Faults f7 & f8 terminate in splays near the Malmesbury Formation contact, whilst f9 follows the contact some distance further south. Some EW faults seem to cut or cross over the NW faults, such as E2 over f4.3 and E6 over f5.1, indicating a possible younger age. Of the NE faults most terminate at the NW ones (f1), with only one small fault cutting f4 and f4.2 in the ORS. This appears to show that the 3 sets of faults are contemporaneous, with possible later tectonics reactivating some of the faults which stop at existing fault planes.



4.4 HYDROGEOLOGY

4.4.1 Aquifers

As discussed earlier there are 2 major aquifer systems in the study area. These are the Sandveld and Olifants river primary alluvial aquifer, and the much larger secondary fractured rock aquifer of the TMG.

The Sandveld aquifer covers an area of approximately 630m² in the study area. It varies in width from 20km to 30km and has a variable thickness from a few metres to 100m, but averages around 50m. Water levels are generally less than 10m below surface. There are 5 linear zones of sand deeper than 50m which trend NW and follow paleo-valleys (Geoss, 2004), and these were the target areas for developing wellfields at Graafwater, Wadrif, Leipoldville and Elands Bay (Table 4.4). The aquifer supplies water for agricultural and domestic use, with yields varying from 3-20l/s. The DWAF hydrogeological map puts this area under an

A4/A5 yield class of 2-5l/s and >5l/s respectively. The main towns are totally dependant on this source and the proximity of the aquifers means continued exploitation as demand increases. Graafwater used 0.08Mm³/a, Lamberts Bay used 0.6Mm³/a and Elands Bay used 0.004Mm³/a in 2003(Nel, 2004) whilst the water use of Lamberts Bay has more than doubled since 1993(Dyason, 1993 in Nel, 2004). Irrigation is a major consumer from the primary aquifer, extracting some 1.1Mm³ in the Wadrif area alone in 2003 (Nel, 2004).

**Table 4.4 Some characteristics of the primary aquifer
(adapted from Geoss, 2004)**

| Area | Thickness(m) | EC (mS/m) | S (Mm ³) | T (m ² /d) |
|--------------|--------------|-----------|----------------------|-----------------------|
| Wadrif | 30 | 70-140 | 6.2 | |
| Elands Bay | 15 | 70 | 7 | 600 |
| Graafwater | 40-80 | 50-75 | 4 | 20-170 |
| Leipoldville | 31 | 101 | 7.3 | 244 |



The alluvium in the Olifants River valley occurs for approximately 10km north of Citrusdal along parts of the river and is not exploited to any large extent, with the practice being to case off the boreholes up to the underlying secondary aquifer. The aquifer is shallow with some gravel present with the sands, and thicknesses vary from 6-20m (BKS & NinhamShand, 1998b in Parsons & Associates, 2005).

The secondary TMG aquifer extends across the whole study area covering approximately 7200km². It has variable thicknesses from the coast (500m) to the Olifants River Syncline (3000m) to the eastern mountains (> 1000m). The lithological units compose the TMG into a series of aquifers and aquitards. The basement aquitard is the Malmesbury formation, on which lies the lower aquifer consisting of the Piekenierskloof, Graafwater and Peninsula Formations. The Cederberg shale formation forms the aquitard between the lower and upper TMG aquifers, and it is remarkably persistent throughout the area.

The upper aquifer is the Nardouw Subgroup, and it is capped by the Bokkeveld aquitard. Thus the TMG can be described as a super aquifer divided by aquitards that create open or confined conditions. The separation into upper and lower aquifers based on the position of the aquitards has marked impacts on the hydrogeology. The aquifer parameters for the TMG are variable, and attempts have been made to try to correlate these with the formation type (Umvoto/SRK, 2000) (SRK, 2004 in Parsons & Associates, 2005) but results have not been able to show conclusive links. Yields vary from 1.0l/s to as high as 120l/s (Umvoto, 2000) but this high figure was reduced to 25l/s sustainable yield (SRK, 2004). The DWAF hydrogeological map of Calvinia (Zenzile, 2002) uses a yield class of b4 (2-5l/s) for the Piekenierskloof Formation and b5 (>5l/s) for the Peninsula and Nardouw. Storativity is variously estimated as between 0.1 to 0.0001 (Umvoto & SRK, 2000), (Rosewarne, 2002) seeming to be a function of the method of calculation and the area being investigated. This disparity impacts on estimating the capacity of the TMG aquifer. There is also variability in chemistry of the water in the different aquifers, with pH ranges of 5.5-7 and varying iron and manganese contents. Hydraulic conductivities are variously stated as ranging from 0.2-2.0 m/d for the fractured rock and 0.001 m/d for the matrix (Rosewarne, 2002). Transmissivity values were suggested by Rosewarne (2002) as a few hundred m²/d with open fault zones and ~10 m²/d for the matrix, but hugely different values are mentioned for different parts of the TMG. This aquifer is largely anisotropic and does not display uniform aquifer characteristics (Parsons, 2005) and should be investigated and described in a site specific manner. These parameters of the TMG could be applied to the blocks between the faults to try to establish trends or patterns.

4.4.2 Groundwater flow

Groundwater flow reflects active circulation of water in the fractured rock system. Flow-paths are controlled by hydraulic connectivity and steep hydraulic gradients created by recharge in the Cederberg and Olifantsberg mountains (Titus et al, 2002). The role of structures in determining gradients and connectivity will be discussed.

The flow in the sand aquifers are topographically controlled and within the palaeo-channels. The aquifer would be considered a homogenous and isotropic system on an impermeable basement, with flow lines normal to the hydraulic head in a typical flow net pattern. The effects of leakage from the faults underlying the alluvium have not been conclusively established.

Flow in fractured rocks can be studied using Darcy's Law, under certain conditions. The law states

$$Q = \frac{KA(h_a - h_b)}{L}$$

Where

K is the aquifer hydraulic conductivity,
A is the area normal to flow of a block,
 $h_a - h_b$ is the difference in water levels
L is the length of the aquifer.



The conditions would be that a discrete block is selected with known boundaries and geology. There must be good connectivity between fractures, and faults forming boundaries must be barriers to flow. There should also be no confining conditions in any part of the block. There are some parts of the TMG in the study area that meet these conditions.

The importance of pressure heads and elevation heads in the syncline areas such as in the west limb of the ORS, may explain spring flow along the Cederberg contact. Hartnady (2002) uses this concept to explain the hot spring at the Baths, with the high hydraulic head at the elevated east limb forcing water to flow up the lower west limb along a fault to discharge at the spring. There are numerous examples of where these heads in the eastern high mountains could produce uphill flow in opposite limbs of the synclines or force flow along the axis of the fold. Flow down dip of the west limb may intercept the flow coming up from the east limb and be diverted in the horizontal plane north or southward. The major

constraints of studying flow in the TMG is the lack of deep holes to investigate deep flow, with all the present data only going down to depths of < 200m.

Weaver & Rosewarne (2002) ask the question “what is the conceptual model of flow in the TMG aquifer?” They go on to see it as a multiple porosity aquifer which is regionally unconfined but may be locally confined. Umvoto/ SRK (2000) suggest it is made up of several hydrogeologic domains each with unique conceptual models and hydrogeological interrelationships. Kotze & Xu (2003) suggest that aquifer delineation and flow systems, dynamics and parameters be quantified before resource quality objectives are applied. This echoes the thrust of this study. The separation of shallow (local), intermediate and regional (deep) flow based on depth in the TMG is made difficult by the size, stratigraphy and structure of the aquifer. From an analysis of the cross sections it is apparent that the Cederberg aquitard where it occurs separates the TMG into an upper and lower unit (Figure 4.14 A-J). This is usually 500m below sea level and due to topography there are parts of the upper aquifer that rise to 200-300m above sea level. In all sections there is effectively a distinct separation of the Nardouw aquifer from the Peninsula. For the purpose of this study the 2 divisions are adopted, explained and qualified below. The sections also show flow directions, major structures of synclines/anticlines and the catchment boundaries. They are described in detail below. Figure 4.15 shows the flow directions for the upper aquifer (dark blue arrow) and the lower aquifer (light blue/cyan arrow), between the cross sections in a 3D view. [The isometric projection in AutoCAD would not allow the insertion of a legend or any annotations, making it appear incomplete. However the effectiveness in illustrating the directions of flow in the upper (dark blue) and lower (light blue) aquifers is apparent]

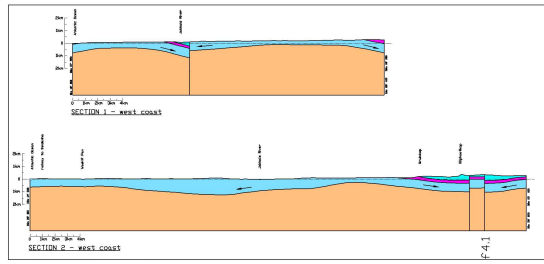
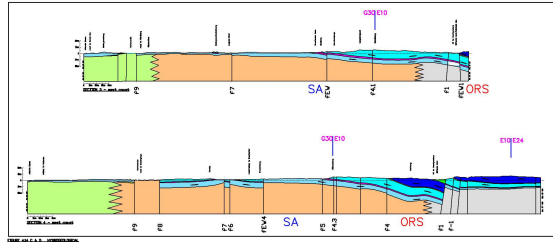
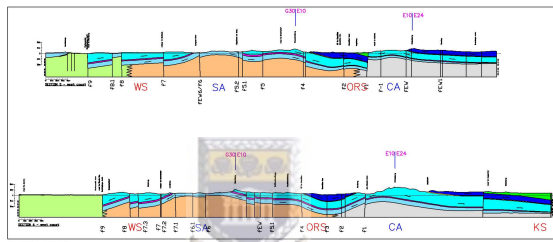

FIGURE 4.14.A.3 - HYDROGEOLOGICAL

See also Appendix D1.



See also Appendix D2.



See also Appendix D3

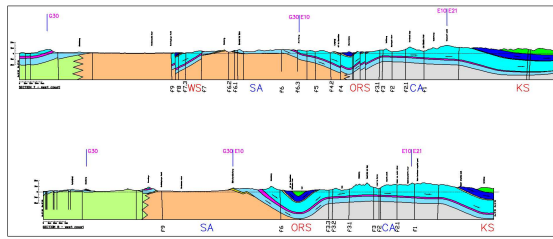

See also Appendix D4

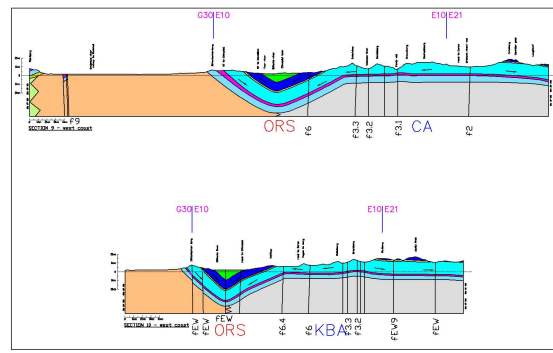

FIGURE 4.14.A.4 - HYDROGEOLOGICAL

See also Appendix D5

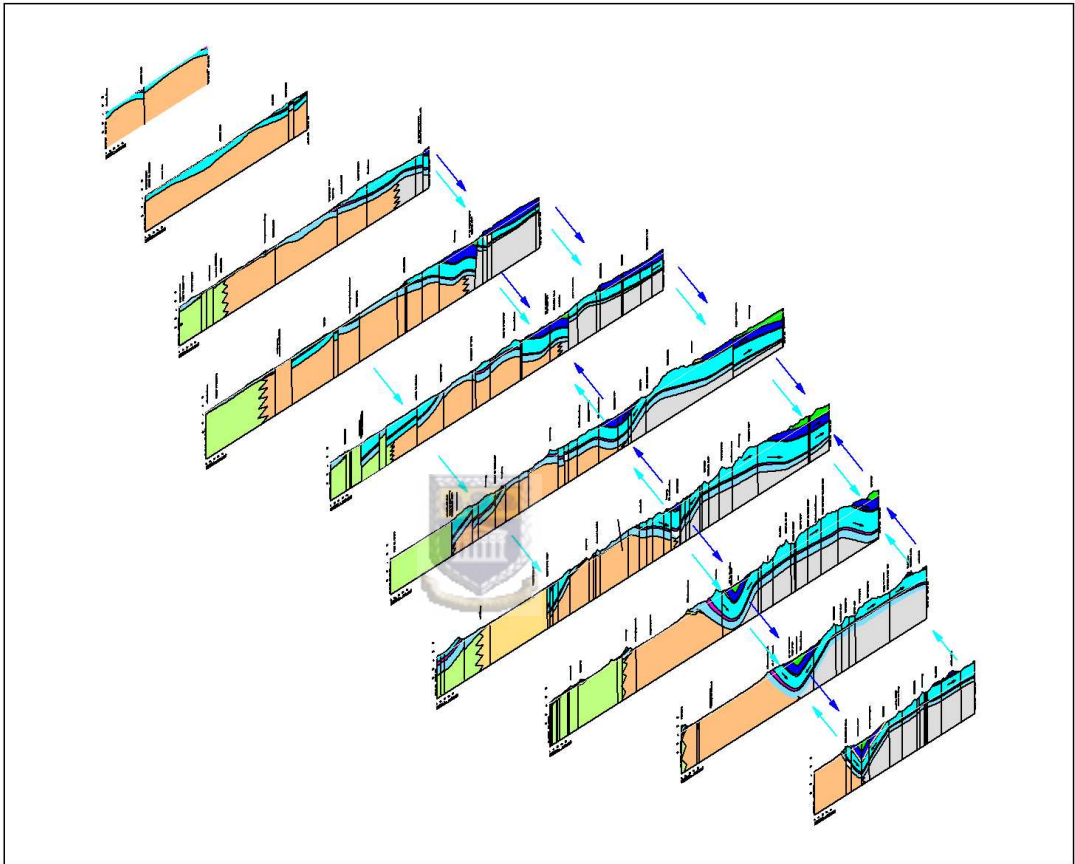

FIGURE 4.15 Isometric flow sections

See also Appendix E.

4.4.2.1 Hydrogeological sections description

The following detailed description of the geology and hydrogeology of the individual cross sections is an attempt to explain the structural controls that are present in the study area. There is also evidence for the 2 aquifer-2 flow system hypothesis proposed for the study. All sections face NW and run from section 1, in the northwest to section 10 in the southeast of the study area. These sections were drawn from the 1: 50 000 geo/ topographical maps at the CGS. They are balanced sections with no vertical exaggeration. The figures below have been reduced to facilitate the description of each, and have lost some detail in the process. However they are still useful in conceptualizing the information presented.

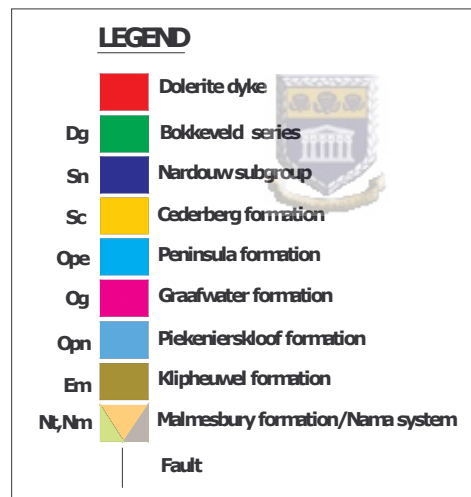

Figure 4.16 Stratigraphic sequence for cross sections below

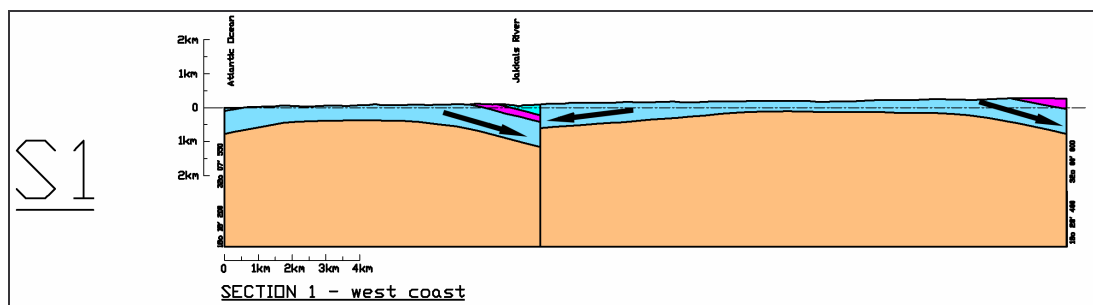

Figure 4.16 a Cross section 1 showing flow direction.

Geology:

Figure 4.16a shows cross section 1 with a normal fault near the Jackals River, with a downthrow to the west. There is a possible intersection of an east/west and northwest fault here. Gently folded geology occurs with an exposure of Graafwater and Peninsula Formations on downthrown side of the fault. Some 200-300m of Piekenierskloof Formation lies on basement Malmesbury shale, thinning out to the northern and western margins of the depositional basin. Western limb is a shallow anticline towards the Atlantic.

Hydrogeology:

There is a large area for recharge from precipitation directly into 1^o and 2^o aquifer. Aquifer geometry is shallow and flat. Local flow in the east is towards the fault and the Jakkals River, and towards the west and east on the opposite side of the fault. The main flow is northwest towards the sea.

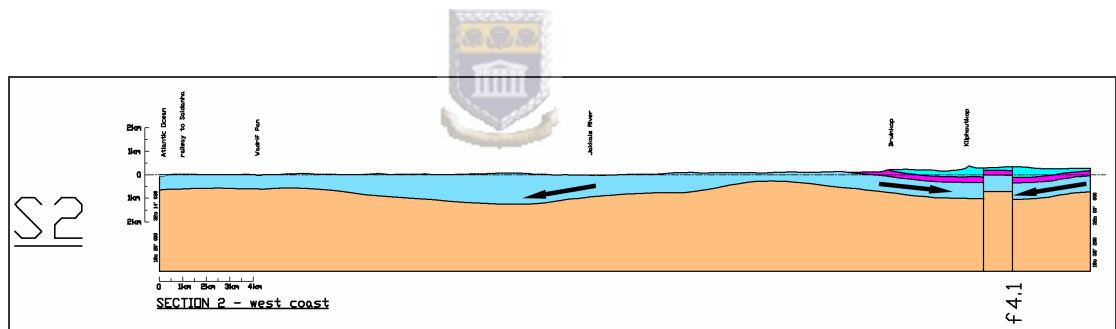

Figure 4.16 b Cross section 2 showing flow direction.

Geology

Figure 4.16b of cross section 2 shows a gently folded Piekenierskloof Formation within a shallow syncline in the east, block faulted horst and graben feature with displacement of ~100m exposes Graafwater Formation on the slope of Bruinkop (327m) and the steep peak of Kliphoutkop (450masl) in resistant Peninsula Formation. The thickness of the TMG is between 300-700m and a diamond drill borehole (G40145) drilled at Rietfontein near Jakkals river intersected Malmesbury basement at 750m.

Hydrogeology

There is potential recharge into the Quarternary and recent sand layers of the primary aquifer. On the east side in the hills there is some direct recharge to the secondary aquifer into the Peninsula Graafwater and Piekenierskloof Formation. The flow direction shows no link to the east, but seems to follow a northwesterly direction. There can be some fault control on flow due to the block faulting, with lateral flow being channeled northwest.

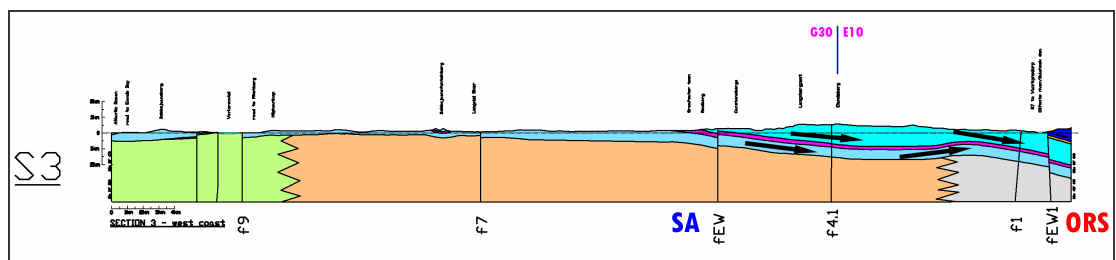

Figure 4.16 c Cross section 3 showing flow direction.

Geology

In Figure 4.16c. of cross section 3 the underlying basement extends across the entire section. From left to right a thin (150m) Piekenierskloof Formation with wedges of Klipheuwel Formation is exposed near Verlorenvlei. The formation begins to thicken to 500m eastward where the Graafwater and Peninsula Formations appear. A remnant of both is seen at Bobbejaansfonteinberg (260masl). From Carstenberg (300masl) the resistant Peninsula Formation extends eastward to the Olifants River (60masl), with Langebergpunt (553masl) and Elandsberg (560masl) forming the higher ground. The full sequence of TMG formations develops in the gently folded west limb of the Orange River Syncline (ORS) at the end of the section. A normal fault displaces the Cederberg Formation and Nardouw Subgroup with a 100m downthrow to the east.

Hydrogeology

To the west side of the Swartberg Anticline (SA) the aquifer is fairly flat for lateral flow with a possible flow direction to the north or south. Eastward is the west limb of the ORS. Shallow dips to the east indicate probable flow in that direction towards the axis of the syncline. There may be a boundary or barrier to

flow at the displaced large (EW1) fault. The probable flow gradient is east and south, for both local and regional flow. There is a separation of the local flow above the Cederberg shale and regional (deep) flow below it where there are expected confined conditions.

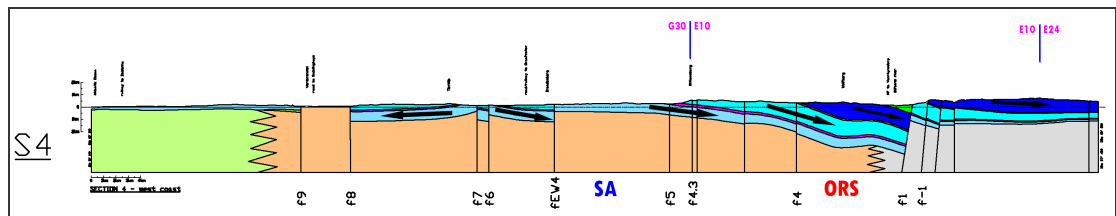

Figure 4.16 d Cross section 4 showing flow direction.

Geology

In Figure 4.16d of cross section 4, a thin (50m) Piekenierskloof Formation with a wedge of Klipheuvel Formation lays atop basement shales to the Verlorenvlei, where the Redelinghuys fault (f9) has displaced the TMG and uplifted the Malmesbury. East of the f8 fault the sequence of Piekenierskloof, Graafwater and Peninsula Formations are successively faulted into blocks to the east. Downthrow of about 300m and some tilting of blocks occur between faults f7 and f6, which is listric and is part of the Swartberg Anticline. Intermittent exposure of underlying Piekenierskloof and Graafwater Formation occurs until Uitskomberg(480masl), then resistant Peninsula Formation forms a range of low mountains which dip towards the west limb of the ORS. Here the Cederberg and Nardouw appear in the shallow dipping west limb of the syncline, which has a depth here of about 1500m below sea level. A large normal fault (f1) shows greatest downthrow to the west of almost 900m. The footwall side is downthrown and juxtaposes the Bokkeveld Group with the Lower Peninsula Formation. There is a rise of topography to 500masl to the east of the fault where the Cederberg Formation and then Nardouw Subgroup is exposed in the mountain areas at 600masl elevation. Here the full sequence of the TMG occurs but is block faulted en-echelon and slightly displaced and thins out eastward to less than 500m. Here the aquifer is only 500m below sea level although still 1000m thick overall.

Hydrogeology

The west side of the section is cut by the large Redelinghuys fault (f9) exposing the basement and effectively separating the Piekenierskloof Formation from the rest of the TMG aquifer. The relatively impermeable Malmesbury shale below Verlorenvlei as well as the abutment of the up thrown Piekenierskloof sandstone to the west of the fault may have contributed to the creation of the lake. From the f7 and f6 faults blocks of offset Piekenierskloof and Graafwater Formation create a flow to the west of f7 and to the east off f6. Due to the Malmesbury shale forming a barrier to this flow east and west, there appears to be a southward flow component towards section 5 along faults f8 and E4. To the east there is a large exposure of Piekenierskloof Formation and the general dip of the stratigraphic units are shallow to the east into the ORS. The Graafwater, Peninsula and Nardouw have a large surface expression for recharge although elevations are only 360m at Wolfberg and the rainfall is lower. Due to the impermeable Cederberg shale there is a division of the aquifer into 2 parts, with a separation of flow into upper (local) and lower (regional). Direction of flow is eastward for both, following the dip of the strata into the axis of the syncline and coming up against the major fault (f1), effectively being confined in 3 directions. There seems only to be lateral flow which is deflected southward. The significant upthrow to the east of the fault causes the abutment of Piekenierskloof, Graafwater and Peninsula Formations against the Nama phyllites. The nature of the fault displacement and the lithology of the Nama would suggest fault sealing by smearing of the shale material as fault gouge or slickenside. This would effectively seal flow to the east and deep flow would be confined and move southward into the trough below section 5. East of the fault (f1) there is limited exposure of Peninsula Formation for recharge, but the Nardouw Subgroup extends to the end of the section and receives most of the recharge, with the dips becoming shallow the aquifer forms a flow trap. In the underlying deeper aquifer with confined conditions below the Cederberg Formation flow is also southward. A set of three faults (f-1) could be restricting flow eastward but gradients are small for north or southward flow, producing a “stagnant” zone which could possibly contribute to spring flow.

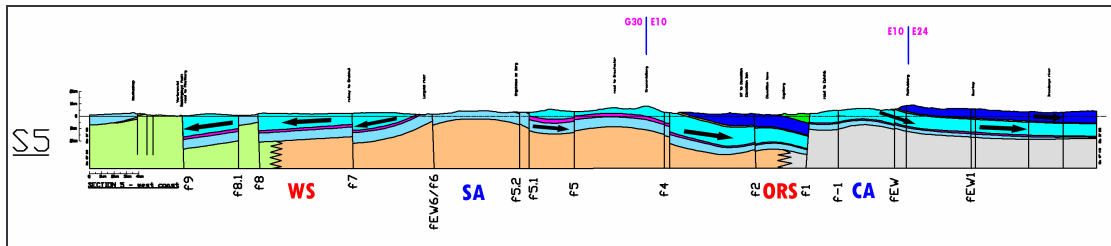

Figure 4.16 e Cross section 5 showing flow direction.

Geology

Figure 1.16e of cross section5 shows in the west the Piekenierskloof Formation forms a ridge of elevated ground, Houthoek (260masl) overlaying a faulted thin wedge of Klipheuvel Formation. There is a flat area of basement rocks towards the Verlorenvlei River and the Redelinghuys fault (f9). East of this fault, within the Waterberg Syncline (WS), a series of normal faults displace the TMG sequence of Piekenierskloof, Graafwater and Peninsula Formations with a downthrow to the east, but between f8.1 and f8 the block is upthrown to expose the underlying Piekenierskloof. In the Swartberg Anticline between the Langvlei River at f6 and Engelsman se Berg, the Graafwater and Peninsula formation has been eroded away and the opposite dipping limbs show displacement at f5.2, f5.1 and f5. Kroonsvleiberg (804masl) in the Peninsula formation is at the descending west limb of the ORS and Cederberg formation and Nardouw subgroup are exposed in the Olifants river valley, and beyond Clanwilliam the Bokkeveld Group is encountered in the Augsberg hills (160masl) as a wedge against f1. The east side is upthrown by almost 1000m, placing Peninsula Formation in contact with Bokkeveld rocks in the axis of the Cederberg anticline (CA) at 600masl. There is a shallow dip to the east with the Cederberg Formation and Nardouw Subgroup confining the lower aquifer. At Pakhuisberg (930masl) and towards the Suurkop (653masl) the Nardouw Subgroup is exposed to recharge and is cut by easterly faults E and E1.

Hydrogeology

The Waterberg Syncline shows a sequence thickness of more than 600m but block faulting has again separated the aquifer into separate units. Flow seems to be to the west and south in the different compartments with the upthrown block effectively separating the aquifer at the contact of impermeable basement shale at f8.1 and f8.

At the limbs of the Swartberg Anticline the flow appears east and west, with the former having a southward component due to the shallow curve of the rocks with a slight rise eastward. The east limb of the anticline flows into the west limb of the ORS, with recharge into the Peninsula Formation being diverted into deep flow to the east. There appears to be a basin effect below this section and the local flow in the Nardouw Subgroup is coming from the direction of section 4 and 6. This would create a high pressure/ hydraulic head in this area with implications for spring flow or fault flow. Deep flow would appear to follow the same pattern. Flow in the west limb of the ORS is steeply east and confined below the Cederberg Formation and Nardouw Subgroup and the deep component is northward into the trough below section 4. On the east side there is a gentle gradient to the east below the confining Cederberg Formation and with a possible “stagnant zone”. The Nardouw Subgroup upper aquifer has a gentle easterly flow with a north component. Interestingly on this section there seems to be a clear flow from catchment G30 into E10, as well as from catchment E10 into E24 in the east.

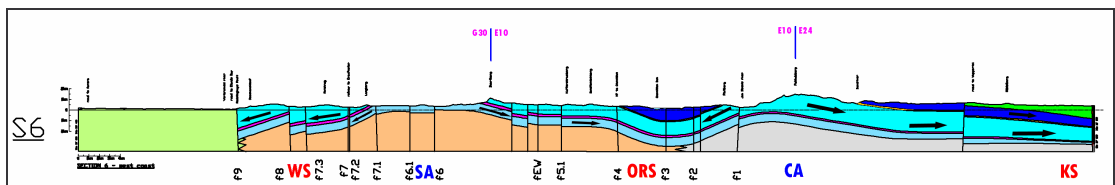

Figure 4.16 f Cross section 6 showing flow direction.

Geology

Cross section 6 in Figure 4.16f is the longest section of the set, with basement rocks in the west (80masl) up to the Redelinghuys fault (f9) where displacement exposes only the east limb of the Waterberg Syncline. The resistant Peninsula

Formation forming the Boesmanskloof (320masl) and Rotelrug (400masl) mountains, dipping to the west at a steep angle is offset by a series of faults f8 and f7.3. A thin upthrown segment between F7 and f7.2 faults puts the lowest Piekenierskloof Formation between Peninsula Formation and the basement shale. The eroded upper part of the syncline exposes a wide valley with Piekenierskloof Formation exposed in low hills (380masl) with the Graafwater and Peninsula Formations forming the east and west limbs at the Swartberg (1040masl) and Langberg (380masl) respectively. Shallow dipping resistant Peninsula Formation forms a range of high hills (Sandfonteinberg, 480masl) towards the ORS at Clanwilliam. The syncline shows a complete fold with both east and west limbs completing geological sequences with several faults showing minor displacements. The Olifants River here sits atop the Nardouw Subgroup with moderate relief features. Further east the Cederberg anticline exposes the Peninsula formation where overlying Nardouw Subgroup and Cederberg Formation have been eroded away, giving the highest elevation in the Pakhuisberg mountains(1380masl). The highly resistant nature of the Peninsula Formation results in the elevated (1200masl), rugged topography seen here. No major throw is shown on the few faults that occur here with a small displacement of approximately 150m downthrow to the east. The east limb of the anticline dips gently to the east and thins out, but the full sequence of lithologies is maintained. The extreme end of the section intersects a thin dolerite dyke, thought to be part of the Tankwa dyke system of the Karoo.

Hydrogeology

The juxtaposed Malmesbury Formation against the TMG at the Redelinghuys fault due to the large displacement by this fault effectively bounds flow to the east. Block faulting of the TMG here has compartmentalized this part of the Waterberg syncline, with an average elevation of 450masl, with flow being forced in a west and southward direction. Between the Langberg and Swartberg mountains in the Peninsula Formation the eroded anticline exposes the lowermost Piekenierskloof Formation to recharge and this would flow east and west in the limbs of the fold. The shallow dipping Peninsula Formation is well exposed

towards the ORS where flow is easterly with the deep confined flow being northward. The unconfined Nardouw Subgroup aquifer has flow in towards the axis of the syncline and local flow towards the north into the “trough” below section 5. Deep flow from the east limb would be westward and confined, also having a northward component at depth. The Cederberg Anticline east of the Jan Dissels River has the largest and highest exposure of Peninsula Formation and recharge in this high rainfall region would be directed in a mainly eastward direction with a smaller westward component. There appears also to be a strong northward flow in the Peninsula and Piekenierskloof Formation. The confining conditions in the Peninsula Formation begin at the Sandriver and extend below the Nardouw Subgroup and Bokkeveld Group to the east, being displaced by about 100m by a fault. Flow in the confined Peninsula Formation is eastward towards the Krakadouw Syncline (KS) as well as northward towards Section 5. The dolerite dyke is a significant barrier to the eastward flow in the Peninsula and Nardouw aquifers and may create “dead” zones, or if fractured country rock is present flanking the dyke, some leakage upward may occur.

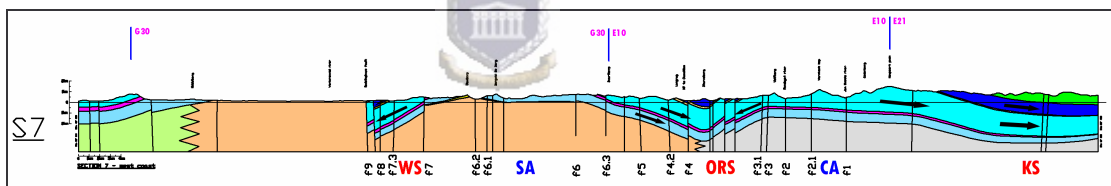

Figure 4.16 g Cross section 7 showing flow direction.

Geology

Figure 4.16g shows cross section 7. Another of the long sections, it starts in the westerly dipping monoclinical Piketberg outlier (720masl). The TMG here thins out at the Middelberg (300masl). The basement is exposed to the Redelinghuys fault (f9) where the down-faulted TMG sequence appears. This is the remnant east limb of the Waterberg Syncline which dips steeply to the west. The Klipheuwel Formation is exposed at the Blouberg hills (660masl) where the basement disappears under the TMG. This is the axis of the Swartberg Anticline at the Bergvlei se berg (780masl) where the thin Piekenierskloof Formation is all that’s left of the eroded sequence. Eastward the softer Graafwater Formation is exposed in the west limb of the ORS where some en-echelon block faulting has created a

series of repetitive displaced exposures of the Cederberg Formation and Nardouw Subgroup, but the full sequence of the TMG is mainly intact. The dips are much steeper (-20°) in the limbs of the syncline, which show tighter folding. East of the syncline the wide Cederberg Anticline hinge is of heavily eroded Peninsula Formation and forms the resistant mountain ranges of the Cederberg, with high peaks of the Wolfberg (780masl), Warmhoek Kop (1120masl) and Koupoort peak (1440masl). Further east the Cederberg Formation and Nardouw Subgroup are overlain by the Bokkeveld Group in the eastern margin of the section, with high relief but less rugged ranges than the Peninsula Formation in the Krakadouw Syncline (KS).

Hydrogeology

Recharge and flow in the extreme west within the Piketberg outlier is westward following the dip of the stratigraphic units of the Piekenierskloof, Graafwater and Peninsula Formation. The impermeable basement effectively separates this area from the faulted west limb of the Waterberg monocline at the Redelinghuys fault (f9). Here the block faulting and small displacements divide the limb into units that are confined by the Cederberg Formation and Nardouw Subgroup. Local flow above the Cederberg Formation is southward, as is the deep flow in the confined Peninsula and Piekenierskloof Formation. The steep dipping units give a westward flow to the recharge into the Piekenierskloof and Peninsula Formation and Nardouw Subgroup. From the Bergvlei Se Berg (780masl) the Piekenierskloof Formation is almost horizontal until the OR S where it dips steeply into the nose of the fold. There is a stratigraphic high/groundwater divide below this section and the local and deep flow appears north and southward away from the plane of the section under confining conditions (Figure 4.15). The Peninsula Formation recharge area is exposed over a large area and the gentle eastward dip controls the flow in this direction, but after the Koupoort peak (1400masl) the aquifer becomes confined with thick sequences of the Cederberg Formation, Nardouw Subgroup and Bokkeveld Group. Deep flow in the axis of the anticline has a northward component into a trough below Section 5. In the eastern part the confined aquifer of the deeper Peninsula Formation and the overlying Nardouw Subgroup have

eastward flow with a southward component in the Krakadouw Syncline towards another trough below section 9(Figure 4.15).

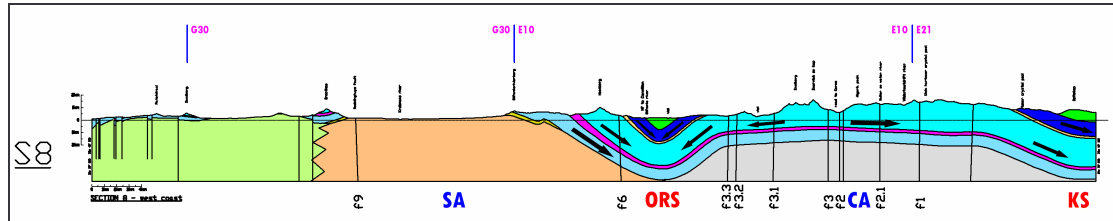

Figure 4.16 h Cross section 8 showing flow direction.

Geology

The western part of cross section 8 in Figure 4.16h show much thinner Piekenierskloof Formation in the Piketberg range, with the Graafwater and Peninsula Formations appearing as remnants of the shallow basin edge deposits in the upper parts of the Sandberg(520masl) and Grootkop(820masl). There are large areas of the basement below the sand cover, with thin lens of the Klipheuvell shale appearing on either side of the Kruismans River (88masl) in the Malmesbury shale. The resistant Piekenierskloof Formation forms the Olifantsrivierberg range (740masl). There is a thick exposure of the less resistant Graafwater Formation which forms negative relief before the Maanberg (1000masl) which rises in the resistant Peninsula Formation on the west limb of the ORS. The thin Cederberg Formation and low relief of the Nardouw Subgroup appear in the shallow but wide valley of the Olifants River, and the Bokkeveld Group cover makes up the lowest part of the flat valley floor. The TMG is deepest in this area (>3000mbsl) and the fold hinge begins to become tighter although faulting appears greatly reduced. The prominent and extremely rugged relief is a result of the extensive exposure of the resistant Peninsula Formation, giving rise to high peaks such as Smallberg (1380masl), Suurvlok Se Kop(1600masl), Algeria(1260masl) etc. These ranges form the shallow Cederberg Anticline and are the erosional remnants of the lower parts of the TMG. Fault f3 near Algeria is sealed and brecciated in an exposure along the road and although no displacement is shown there is a concentration of the main faults such as f3.3, f3.2, f3.1, f3, f2 and f1. The Peninsula Formation is also thickest in this area. In the extreme east the steep

dipping west limb of the Krakadouw Syncline shows the erosional surface at the very top of the complete sequence of the Bokkeveld and TMG.

Hydrogeology

The thin segments of the TMG in the west are only ~100 m thick, and the low rainfall in the area makes recharge contribution to flow limited to small amounts towards the north. Grootkop (820masl) is an isolated hill with localized flow from local rainfall. From the Olifantsrivierberg (740masl) to the Maanberg (1000masl) a large area of the TMG sequence is exposed in the west limb of the ORS, and with its higher rainfall and recharge, flow is towards the east in the steeply dipping strata. Here inter- catchment flow from G30 into E10 occurs. Flow from the east limb is westward, but there appears also a strong southward flow in the axis of the fold into the trough. Both the local flow in the Nardouw Subgroup and the deep flow of the Peninsula Formation aquifers follow the plunge of the syncline axis southward. The flat Cederberg Anticline to the east of the ORS exposes the largest part of the Peninsula in the area of highest rainfall, with the greatest recharge contributing to an east and west flow pattern with a southward deep flow component. Faults would appear to deflect flow northwestward. To the east the Krakadouw Syncline draws flow in an easterly direction into the west limb of the fold in a confining environment both in the lower and upper aquifer. There may be trough conditions here and high confined hydraulic pressures especially in the lower part. Local flow in the Nardouw Subgroup is thus eastward and deep flow east and then northward along the plunge of the fold axis.

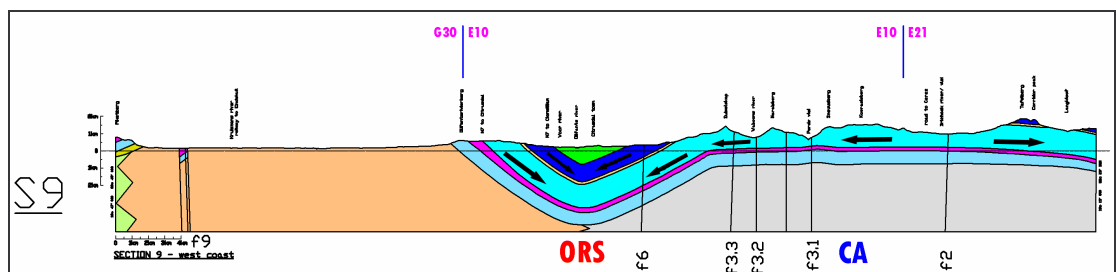

Figure 4.16 i Cross section 9 showing flow direction.

Geology

There is a small section of the Piketberg outlier in the westernmost part of cross section 9 (Figure 4.16i), which overlies the basement with good exposure of Kliphuewel Formation. Basement rocks extend across the plain of the Kruismans River and except for narrow exposures of Graafwater Formation down-thrown by 2 faults (f9) the edge of the flat area culminates in the Olifantsberg range (440masl) which coincides with the bottom of the TMG sequence of the ORS. The full sequence is present here and the limbs of the syncline dip at -40° either side of the Olifants River with a gradual tightening of the syncline southward. Faults are fewer here and have not displaced any of the stratigraphy. Good exposures of the Cederberg Formation and Nardouw Subgroup are seen, and the relief in the Nardouw Subgroup and Bokkeveld Group within the limbs of the syncline is low (~200masl) compared to that of the very high, rugged Peninsula Formation exposed over a large part of the eastern area. Peaks in this region include Duiwelskop (1320masl), Sneeuwberg (1298masl) and Koerosieberg (1390masl). Further east the highest peak, Tafelberg (1760masl) and Corridor Peak are the remnants of the erosion surface, with multiple exposures of Cederberg Formation as the erosion surface cuts back into the Nardouw Subgroup.

Hydrogeology

The Malmesbury shale acts as an impermeable basement to the TMG, and effectively separates the west and east parts of the aquifer. Lower recharge in the west limb of the OR syncline due to lower elevations feeds flow towards the east in the steep dipping Piekenierskloof, Graafwater and Peninsula Formation, becoming confined with depth under the Cederberg Formation aquitard. An aerially much more extensive exposure of the Peninsula sandstone in the east limb, combined with higher elevations and rainfall, contribute to higher recharge in the whole of the eastern part of the section. From the Duiwelskop the higher recharge into the Peninsula Formation contributes to main flow to the west, confined below the Cederberg Formation and with a northward deep flow component. The Nardouw Subgroup is not extensive at surface (450masl) and

recharge is lower. Local flow is confined between the Cederberg shale and Bokkeveld Group towards the nose of the fold and has a southward component, opposite to that of the deep flow. Towards the east the flow is along a shallow gradient along the Cederberg Anticline towards the west limb of the Krakadouw Syncline. Deep flow is northward in the nose of the fold. The basement Namib phyllites are the impervious basement to the TMG here. Substantial hydraulic head pressures must be generated by the thick sequences of lithological units and the depth to fold hinges in the ORS of more than 2000m below sea level.

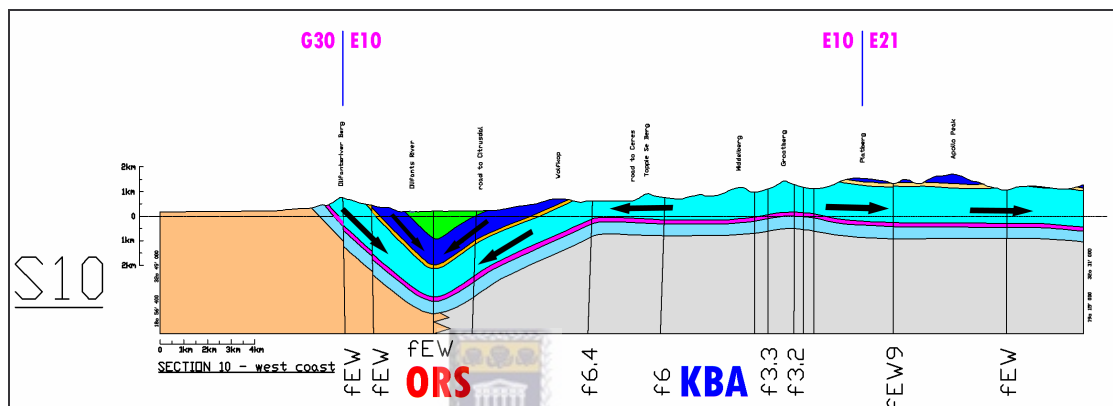

Figure 4.16 j Cross section 10 showing flow direction.

Geology

The last short cross section 10 in Figure 4.16j shows the very prominent deepening and tightening of the ORS as it was deformed. The boundary of the TMG aquifer starts at the Olifantsrivier Berg (740masl) mountains with a steeper and tighter fold axis. A set of easterly faults cause slight displacements in the west limb, but again the eastern faults (f6.4, f6, f3.3) have none. The TMG on the east side shows thinning of units and hence the reduced overall thickness. The sequence although complete is relatively thinner, and progresses into a shallow anticline which again shows rugged relief in the Peninsula Formation areas of the weak Cederberg Anticline. Remnants of the Cederberg Formation and Nardouw Subgroup remain in the highest peaks, Platberg (1500masl) and Apollo (1660masl) producing some confined conditions. The Piekenierskloof Formation has thinned southward and the TMG has a very shallow gradient towards the east.

Hydrogeology

Higher elevations increase rainfall and recharge along the eastern range and this flows westward into the ORS. The steep dips of the strata in the limbs of the fold feed the confined flow into the lower aquifer and then into a northward flow component towards the “trough” below section 8 (Figure 4.15). The overlying confined beds of the upper aquifer of the Nardouw Subgroup direct flow towards the nose of the fold and then to a southward flow, probably caused by the pinch in the axis of the syncline. The shallow anticlinal structure in the east has a large exposure of Peninsula Formation with associated rugged elevated mountains, with higher rainfall and recharge but with shallow gradients for flow eastward. There is also a gentle flow to the south in the Peninsula and Piekenierskloof Formation. This section is important as it is near the site of the Baths thermal spring. It has been postulated that flow from the east limb is forced up the west limb and discharges when it reaches the fault (Umvoto, 2002). The easterly orientation of the faults are probably more likely to tap the deep water in the pressurized nose of the syncline and issue as a hot spring, high yields indicating high pressures maintained over long periods. It is also possible that the trough could extend to below this section, and the higher hydraulic pressures generated by all the deep flow could have one discharge point via the fault into the eye of the spring. The east part has high rainfall and recharge over a very wide area and deep flow would likely be very slow to the east. The Nardouw Subgroup shallow flow in the limited upper aquifer probably contributes to local spring and stream discharge. The easterly faults may be significant to tap deep flow from this high recharge, pressurized system.

4.4.3 Hydrochemistry

This section deals with the effects that structures may have on the hydrochemistry of the TMG. Controls on flow can have an effect on the type of water and where it originates from as well as the time of travel. Chemistry may also indicate if similar water types occur in boreholes, or if they are different indicating another water source. Isotopic composition of water can provide clues as to hydraulic

interconnection and age (Mazor, 1997). Very extensive water sampling was done in the E10 catchment, the Sandveld and in the E10 catchment. These studies attempted to classify groundwater according to lithology (Umvoto/SRK, 2000), to test fault conduit flow and to estimate recharge (Nel, 2005) (Geoss, 2004) and to look at water quality (Parsons, 2005).

The TMG being predominantly inert quartzite makes its waters acidic with low salinity, soft and corrosive and with EC <100mSm (Smart&Tredoux, 2000). The distribution of EC and pH were used in this thesis to investigate any relationship with the faults, and if there were any differences in water chemistry between the blocks. The main limitation was the depth to which these analyses apply as they give an indication only of local flow. Iron and manganese found within the TMG are soluble in the low pH water and orange and black staining is commonly seen in outcrops (Rosewarne, 2002). The precipitation of these elements takes place by oxidation near the surface. Faults often show this characteristic staining (Figure5.1a&b) and sometimes it is seen in bedding and conjugate joints. This is probably a good indication of permeable zones in these structures. More comprehensive chemical studies with available data could be used to identify areas with strong structural controls on flow.

CHAPTER 5 ASSESSING CONTROLS ON GROUNDWATER FLOW

5.1 INTRODUCTION

Structures in the TMG and specifically in the study area show strong influence on the topography and also on the surface drainage patterns. There is an established NW trend to these features as there are for the faults. There is evidence that the same applies to groundwater flow at the local level and is probably also the case for deep flow. The lines of evidence will be led in support of this assumption using a range of data.

5.2 STRUCTURAL EVIDENCE

Mainly based on field evidence the indications of what the characteristics of structures are and the confidence of the assumptions are presented. The different structures are discussed separately.

5.2.1 Faults

There has not been any attempt to classify or characterize faults in the TMG. In the study area a number of different types of faults were identified in the field.

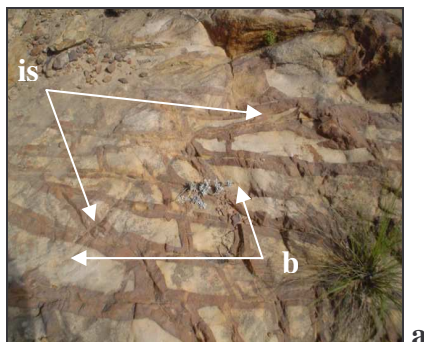

Figure 5.1a Blocky fault breccia

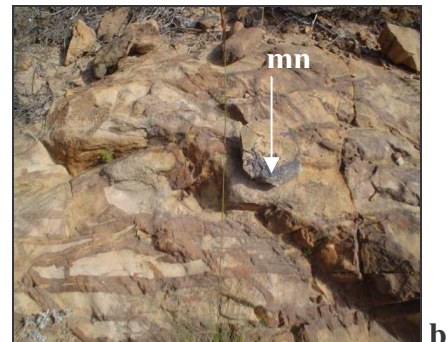

Figure 5.1b Iron & manganese staining

Figure 5.1 shows a large fault (f3.1) in the Cederberg Mountains near Algeria. The fault zone is approximately 10m wide and the photograph shows the 2 m wide fracture zone at the edge of the fault. The blocky fracturing is very obvious, and there is distinct iron staining (is) along the fractures surrounding the blocks (b), suggesting fluid flow along preferred permeable channels. Matrix within the blocks is unaltered and indicates no-flow conditions. The presence of manganese in the rock fragment (mn) on the exposure in Figure 5.1b, also illustrates this preferred flow and oxidation process. The rate of flow or permeability of this zone would be low and in a vertical direction. Horizontal flow across this fault would be expected to be restricted due to the barrier effect of the core.

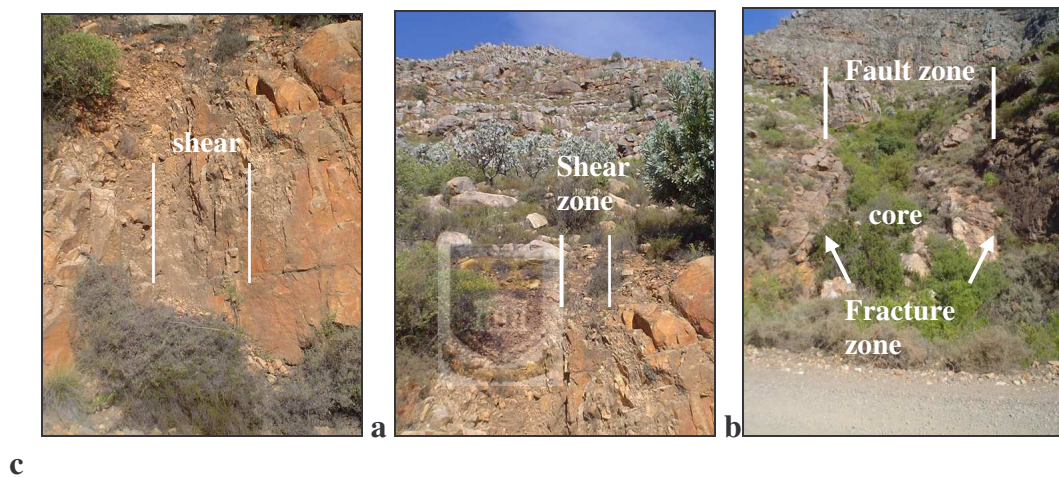

Figure 5.2 a,b & c Two different fault types in the Cederberg Mountains near Algeria.

Less than 50 metres away from the previous fault a minor fault showing a localized thin shear zone is exposed (figure 5.2 a, b). There is high permeability in the shear zone and no fracture zone on either side of it. The fault in figure 5.2c shows a classic fault zone. There is a distinct fracture zone either side of a shrub-choked open central zone which forms a channel for a perennial stream running under the road. There would be both vertical and horizontal components of flow in this fault. There are indications of possible conduit flow in this fault.

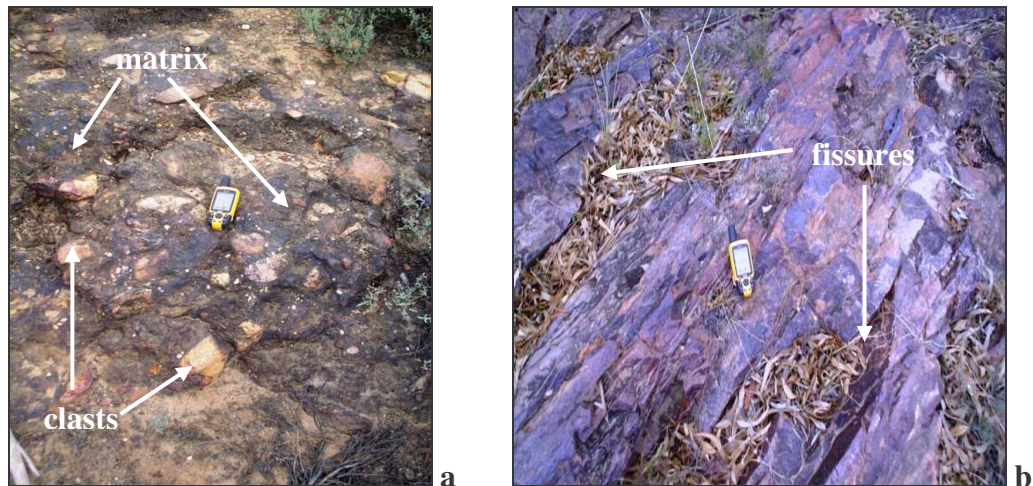

Figure 5.3 a & b Fault breccia and shear in fault zone, Clanwilliam.

About 12 km north of Clanwilliam a splay (EW2) off the main f1 fault is exposed on the banks of the Olifants river. The fault zone is ~10m wide, with a breccia zone (figure 5.3a) 3m wide on the north side and a sheared fault core (figure 5.3b) of 2m width adjacent to it. Both expose strong iron and manganese staining, displaying a dark maroon colour. The breccia shows a porous matrix between the clasts, whilst the shear zone has parallel, thin open fissures. Here the fault would appear to have anisotropic conditions in its core and in the fracture (breccia) zone adjacent to it. Permeability of the fault would be low, with higher values only in the vertical core fissures. This fault would probably act as a barrier to horizontal flow across the aquifer.

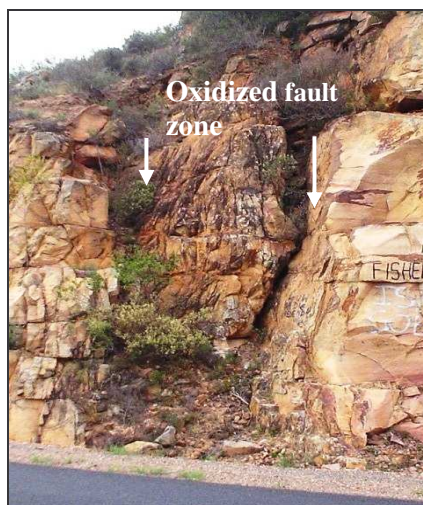

Figure 5.4 Open fault with oxidized zone, near Graafwater.

Along the road to Graafwater about 5km east of the town is a large open fault (f4.3) with a highly deformed core which is strongly oxidized with iron and manganese (figure 5.4). Even allowing for widening by stress release and weathering the aperture of the fault is significant. There is no indication of a high-fracture zone adjacent to the fault nor is the country rock stained to the extent of the fault zone. Conduit flow would be most prominent and good connectivity with the bedding joints would mean high permeability in this fault zone. There is a distinct preferred flow direction along the fault.

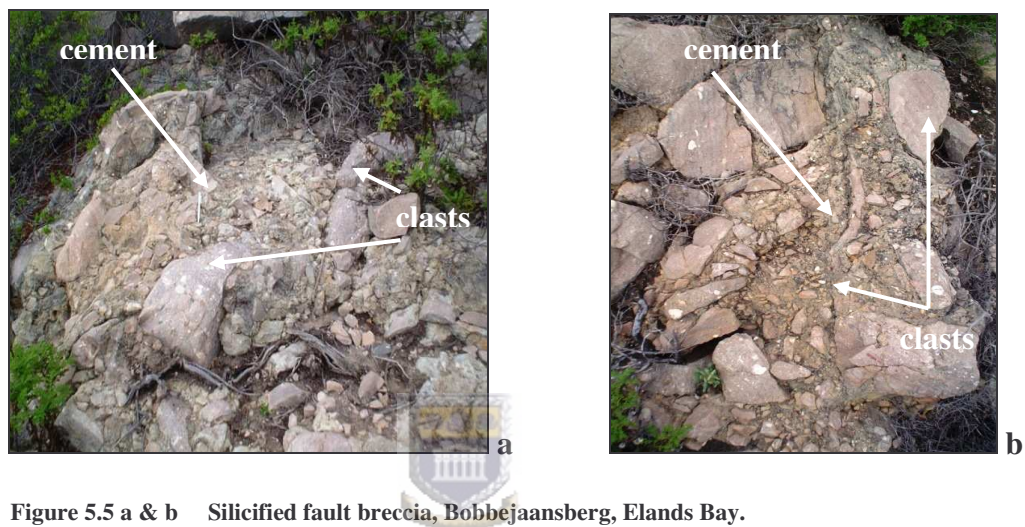

Figure 5.5 a & b Silicified fault breccia, Bobbejaansberg, Elands Bay.

Another type of fault is seen in the Piekenierskloof formation outcrops in Elands Bay, overlooking the fish factory (figure 5.5 a, b). Here a cataclastic event created a 5m wide fault zone with breccia containing large angular clasts of country rock in a siliceous cement. The porous nature of the cement imparts a low permeability to the fault zone, which suggests a semi-permeable barrier to lateral flow across the fault. This fault trends NW parallel to the Redelinghuys (f9) fault to the northeast.

Field evidence suggests that the fault type distribution is variable and atypical. Only intensive field identification and classification according to an accepted system based on orientation, age, fault fill (type and chemistry), dimensions of fault zone etc. would give useful hydraulic properties of the different fault types. This could then be applied to flow estimations at local and regional levels.

5.2.2 Joints and bedding planes

The most consistent and prominent structures within the TMG are the extensively developed joint systems. These have been recognized for their importance in groundwater flow in the context of the study area (Titus et al, 2002) (Umvoto/SRK, 2000) and are explained further here.

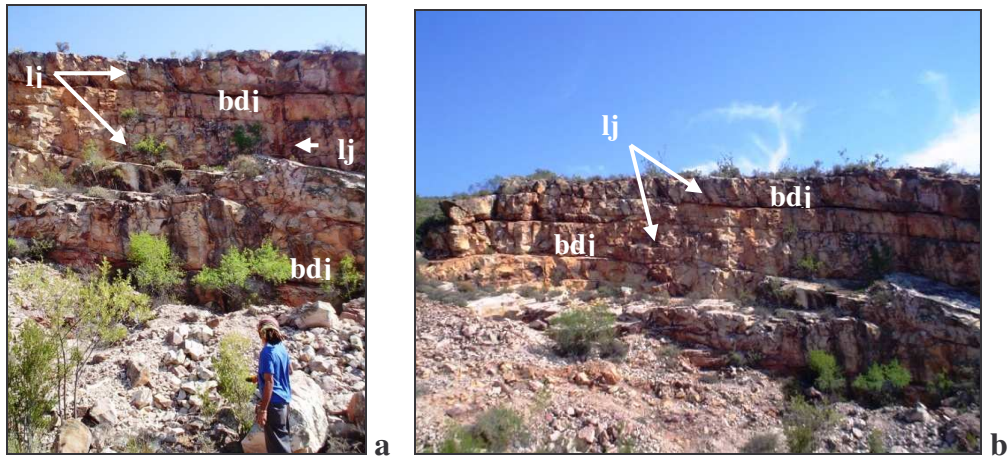

Figure 5.6 a & b Bedding and conjugate joints in Nardouw Subgroup, N7 near Algeria turnoff.

Figure 5.6 illustrates the predominant bedding joints (bdj) in a quarry in the Nardouw formation with longitudinal joints (lj) also well established. The quarry is on the west limb of the Olifants River syncline hence the beds dipping to the right and east. The regular thin (0.5m) bed width is typical of this formation. Connectivity along beds and between beds is very high and show excellent lateral continuity. Due to unloading joint apertures may be exaggerated in the surface outcrop but the significance of their connectivity is still well demonstrated.

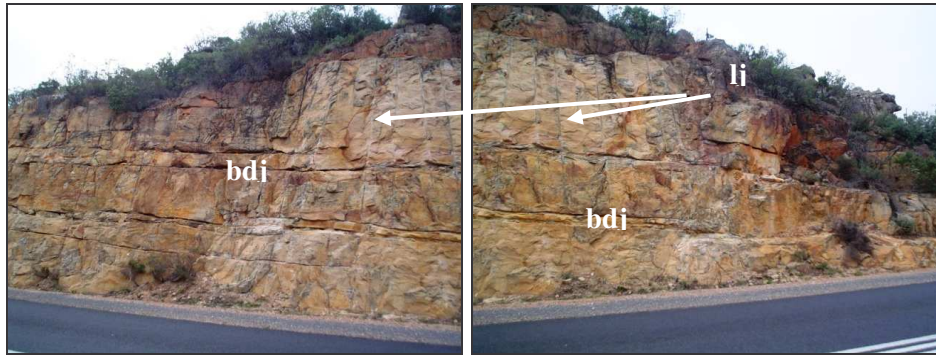
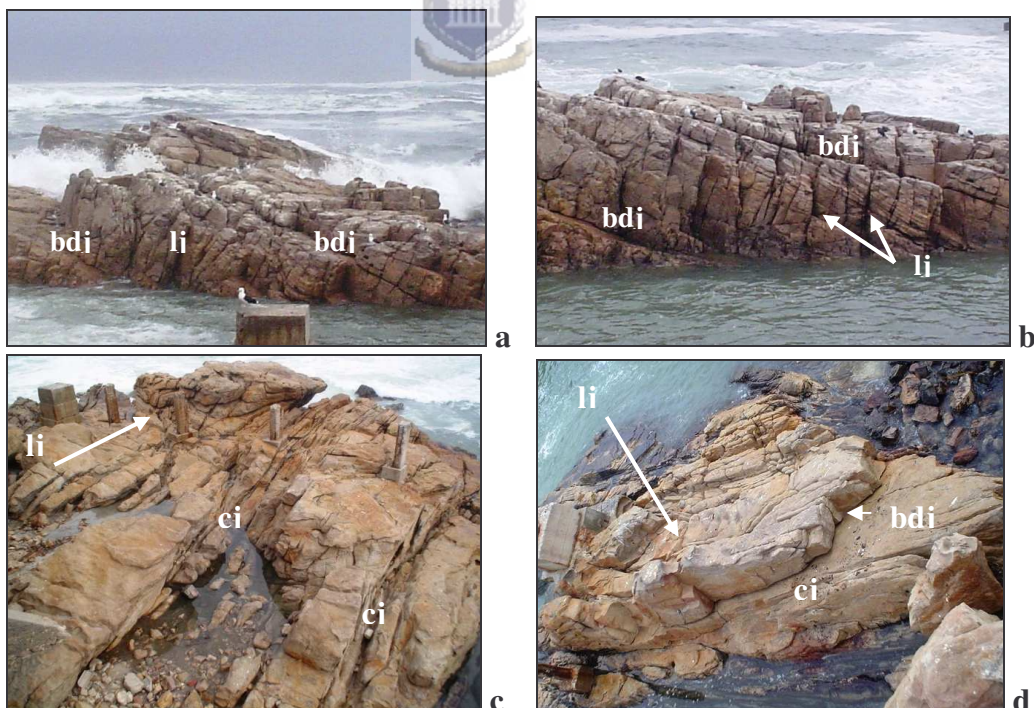

Figure 5.7 Panorama view of bedding planes in Peninsula Formation, near Graafwater.

Along the Graafwater road the Peninsula formation clearly demonstrates the thicker bedding of 2-3m, with well developed continuous bedding joints over a distance of 100m (figure 5.7). The longitudinal joints are more spaced out and thinner and do not stand out at this picture resolution. There is good connectivity along the beds and regular joints cut across all 3 beds in this exposure with localized oxidation along a third oblique joint set cutting the other 2 systems. This is in the east limb of the Swartberg anticline and beds dip at a low angle to the right which is the flow direction



5.8 a, b, c & d Bedding, long and cross joints in Piekenierskloof Formation, Lambert's Bay.

Prominent, very well developed joint sets are seen in coastal exposures of the Piekenierskloof formation north and south of Lamberts Bay (Figure 5.8). The

main bedding planes show preserved cross and foreset depositional features between them (figure 5,8b). The longitudinal and cross joints (cj) are also well displayed and the exposures excellently illustrate the 3D relationship between the joint sets of the area. High connectivity between sets means high permeability for flow and recharge. Bed thickness is variable (0.4- 1.2m), greater than for the Nardouw and less than that for the Peninsula. Dips of beds also vary and here have a shallow easterly direction (figure 5.8 a, b). The different joint sets show clearly in (a&b) bedding and longitudinal joints, (c) prominent cross and minor longitudinal joints and in (d) prominent bedding and minor longitudinal joints.

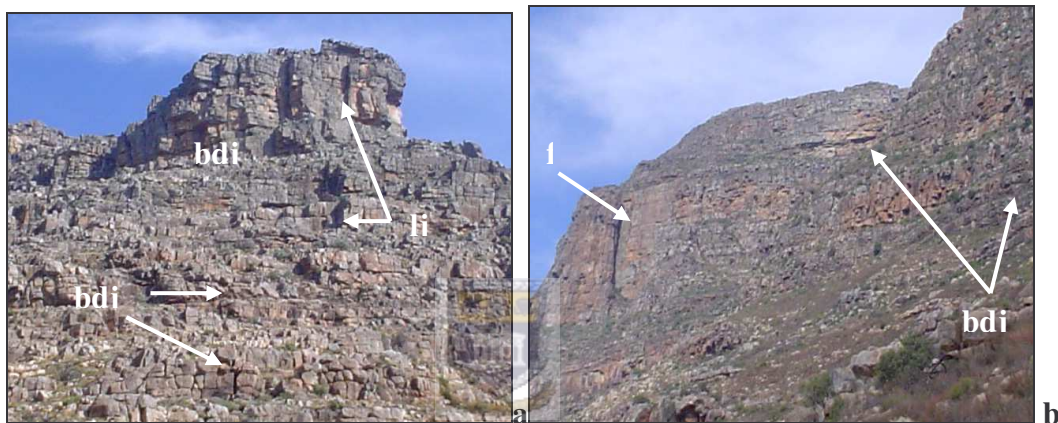

5.9 a & b Bedding and conjugate joints in Peninsula Formation, Cederberg Mountains.

In the high mountain peaks of the Cederberg the pattern of joint sets persists. Here again the prominent bedding joints are well developed and can be followed for hundreds of metres. Longitudinal and cross joint sets can be seen depending on the orientation of the view. In figure 5.9a the close up of the Koerasieberg shows vertical cross joints intersecting horizontal bed joints over vertical distances of 20 -50m, and connectivity is very high due to the huge number of joints at different levels. In figure 5.9b a prominent vertical fissure (f) is seen to the left which is a NE trending fault plane which could increase connectivity over large vertical distances of hundreds of metres. This is the main recharge area for the E10, E21 and E24 catchments and the nature and intensity of fractures would suggest high rates of recharge due to very high permeability of the country rocks.

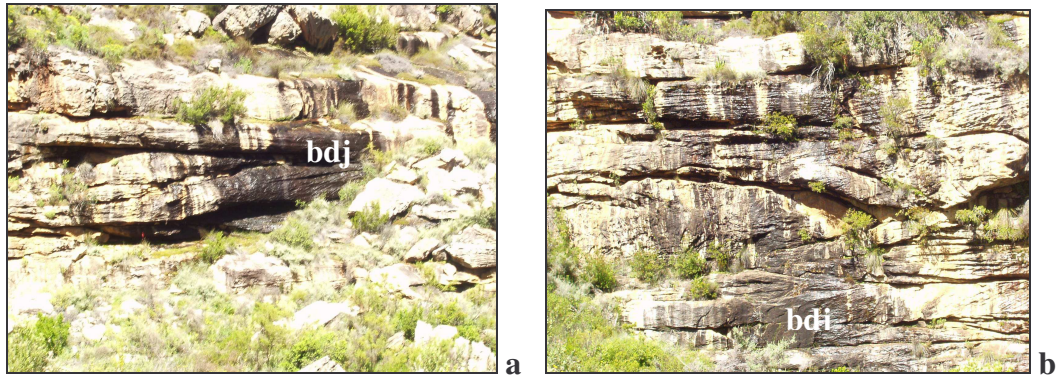

Figure 5.10 a & b Water seeping out of bedding joints in Nardouw Subgroup, Pakhuisberg Pass.

A graphic indication of the significance of bedding joints is shown in figure 5.10. The dark stains are wet rock and the water is running out of horizontal bedding joints dipping towards the camera. The peak of the mountain is 400m above this site, and the Cederberg aquitard is a few metres directly below, suggesting a scenario of groundwater discharge along bedding joints at a lithological/ hydraulic boundary of the upper aquifer.



Field evidence supports the assumption of high connectivity and permeability of the joint structures of the TMG. There also appears to be consistency in these characteristics, as they are seen in parts of the study area ranging from the coast through the mid-altitude highlands into the high-altitude parts of the Clanwilliam and Citrusdal areas. The dips of the bedding planes are good indicators of flow directions in the upper and lower aquifers of the TMG, as indicated on the cross sections. Infiltration is down longitudinal and cross joints and lateral flow is along bedding planes. The apertures of the different joints vary but field indications are that they are generally open to flow along hydraulic gradients.

5.2.3 Lithological contacts

Although contacts are interpolated at depth in the cross sections based on surface orientation and lithology, there are numerous examples of the contacts between the aquifers and the Bokkeveld, Cederberg and Malmesbury aquitards at surface in the study area. Their main implication is the effect they have on flow.

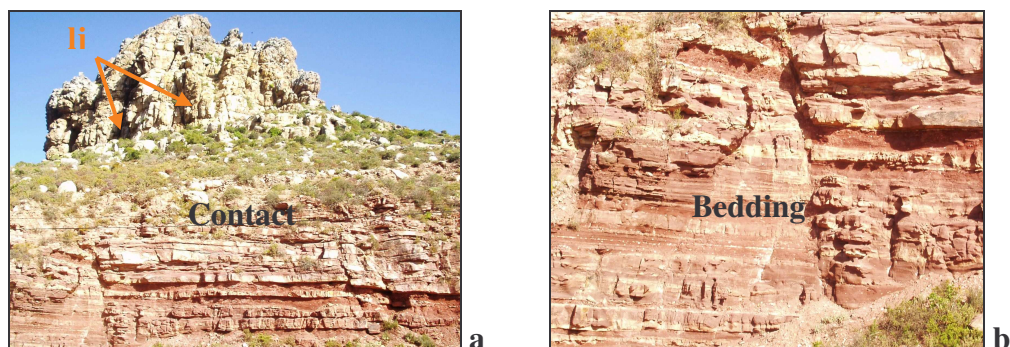

Figure 5.11 a & b Contact zone of Klipheuwel Formation under lying Piekenierskloof Formation, Elands Bay.

Figure 5.11 indicates the unconformity between the TMG and the basement showing the horizontal, bedded alternating shale and silt layers of the Klipheuwel Formation (b) with no visible hydraulic connectivity with the overlying aquifer. The dip of these sediments is downward into the picture (a) indicating a sloping barrier to flow towards the aquifer. The Piekenierskloof Formation shows bedding dipping to the right of the picture and almost vertical longitudinal joints (lj) creating the shadows. Flow would appear to follow these joints and then be deflected at the lithological contact (see cross section 8, Figure 4.14 G&H). A similar scenario is suggested for the contacts between the aquifers and aquitards elsewhere in the TMG, where the zone of contact is the structure. At this interface there is very low hydraulic conductivity.

5.2.4 Rietfontein Diamond drill hole

A deep diamond core borehole number G40145 of 800m depth was drilled on the Rietfontein farm by DWAF (Figure 5.11a-d). It passed through Piekenierskloof Formation rocks and intersected the Malmesbury formation basement contact at ~750m. The hole was core logged, photographed, geophysically surveyed and petrophysically analysed (Titus et al, 2002 b). This borehole is significant as it is the only deep hole to be drilled into the TMG in the study area. Those done by Umvoto/ SRK (2000) in the

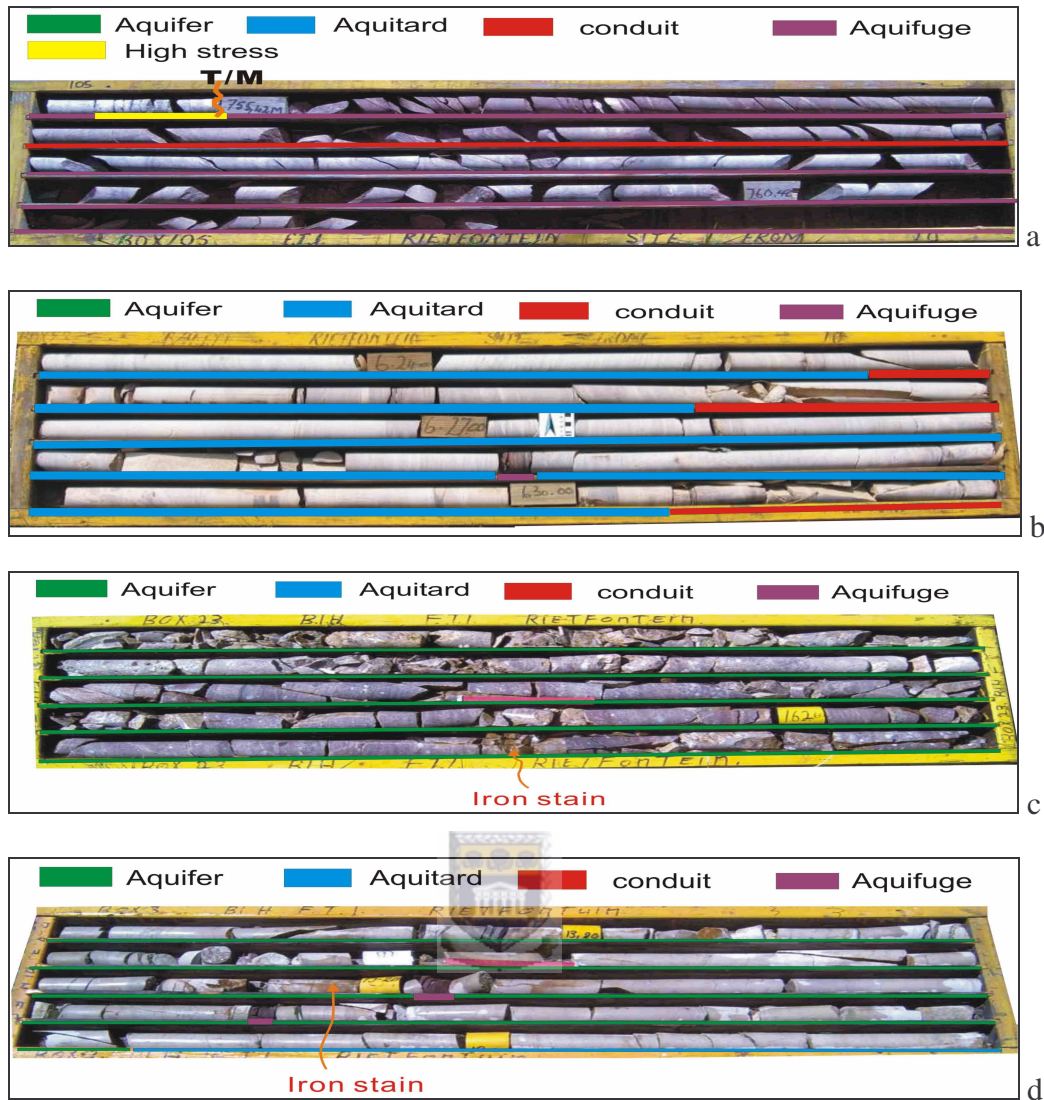

Figure 5.12a –d Core box 105 (a), 88(b), 23(c) &3(d) showing bed and conjugate joints at various depths.

Boschkloof area did not go beyond 280m. Structures are well demonstrated in the core at all depths, as is the contact zone (labeled TM) shown in box 105

Table 5.1 Brief description of selected core boxes from Rietfontein borehole (G 40145)

| BOX NUMBER | DEPTH (m) | CORE DESCRIPTION | STRUCTURES |
|------------|------------|-----------------------------|--|
| 105 | ~754 – 760 | Broken, maroon to grey | Joints sub horizontal, many joints |
| 88 | ~624 - 630 | Clean sandstone | Bed joints horizontal, few vertical joints |
| 23 | ~161 - 166 | Broken, lithology variation | Bed joints horizontal, few vertical joints |
| 3 | ~ 13 - 19 | Clean sandstone | Bed joints & vertical joints showing oxidation |

The depth of the Piekenierskloof to the basement corresponds to that obtained on cross sections 2&3. There appears to be a strong presence of fractures (Table 5.1) throughout the length of the hole in the form of bedding joints, vertical to sub-vertical conjugate joints and fault/ high fracture zones. Connectivity between fractures seems to be high in the sandstone; with interspersed shear zones (box23) indicating very high permeability zones and the contact appears to show a thin conductive zone of a few centimetres before the shale aquitard. All this is useful information when conceptualizing the deep aquifer properties of the TMG.

5.3 HYDROGEOLOGICAL EVIDENCE

The evidence from water level, water chemistry and springs and wetlands is presented below to explain the link with flow and structure. There is an indication of patterns that would support the conceptual flow models proposed.

5.3.1 Water level



The water level data obtained from the different databases were modified to apply to the study. The mean water level was used for each borehole and the data imported into ArcGIS 8.0. The primary and secondary aquifer data were analyzed separately. The data that was available for EC and pH analyses was processed using boreholes that had records, and the data also imported to ArcGIS 8.0. The method used of calculating the data was ordinary Kriging, which was found to give satisfactory interpolations between data points. To increase the levels of accuracy of the interpolations, the data points were grouped into smaller clusters if there were large gaps or distances between boreholes.

In Figure 5.13, water level data was split into a north and south zone. This was done in order to remove the area of no data between them, that could affect the interpolations and create a false contour image.

In the north zone, there is a groundwater watershed along the B, D, E, F line, which has a distinct NW trend. The flow gradient is to the west and also east into

the Olifants River valley. On closer inspection it can be seen that there is a slightly lower saddle at D, which corresponds to EW faults (E3). This indicates a



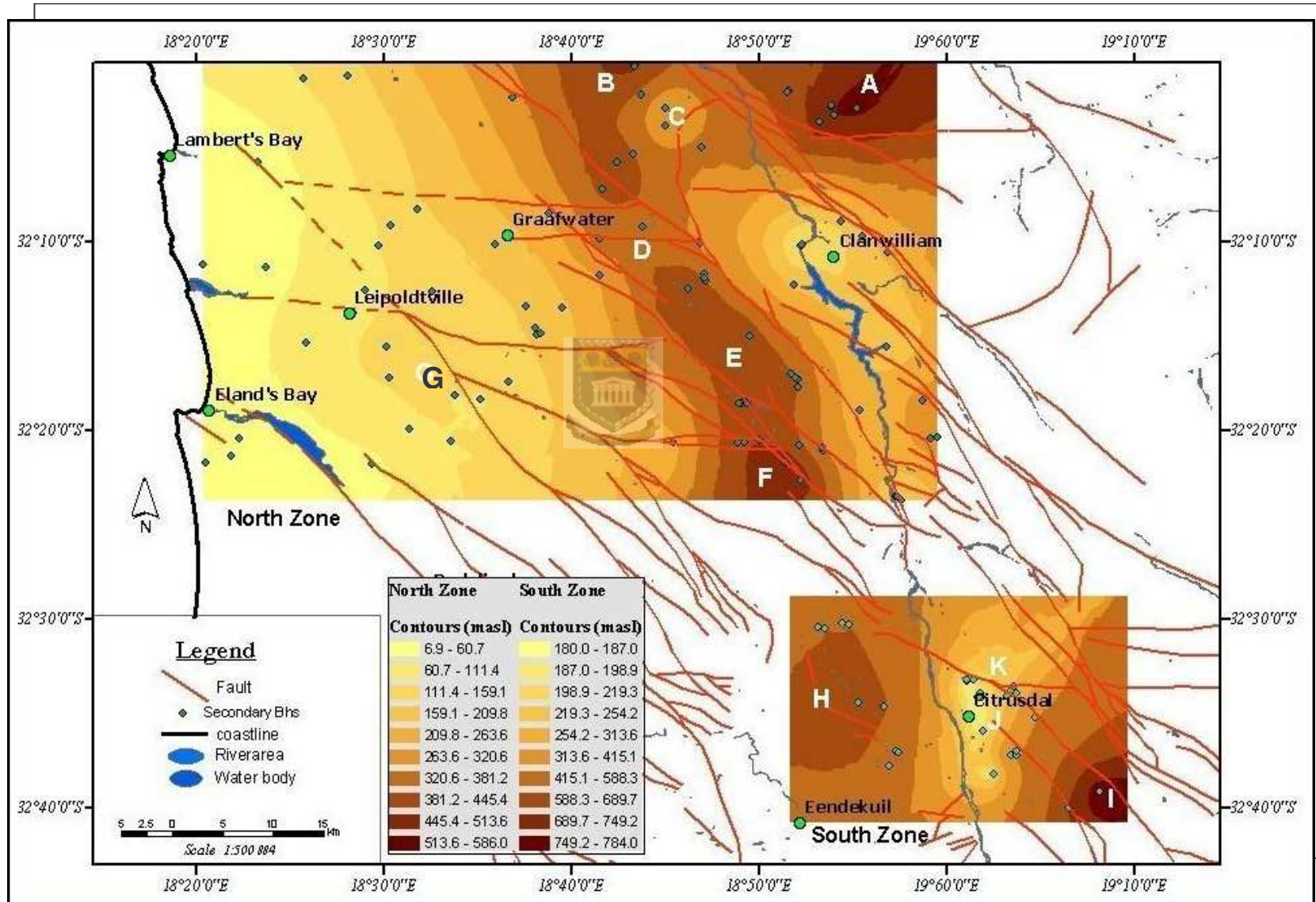

Figure 5.13 Water level contours for the Secondary TMG aquifer (using ordinary Kriging). Arrow lines show flow direction.

possible flow into the fault zone from north and south. The high head at A seems to stop at the cluster of large faults, and could indicate a hydraulic boundary. The low at C may indicate flow into the open tensional curve of the fault or may be a response to lower water levels to the north due to the same fault being a barrier to NW flow from the south. Areas E and F appear to be restricted to within the fault boundaries, probably due to them being closed. The area at G in the west coincides with the major EW fault which follows the magnetic anomaly of the inferred dyke below surface. If the dyke /fault created a barrier to flow there would be a change in direction or deflection to the west, as indicated here.

In the south zone, there appear to be 2 highs either side of the Olifants River valley. Area H is in the west limb of the ORS, and shows flow to the NW, E and SE. The high at I shows a NW flow direction possibly curbed by the NW faults cutting the area. There appears to be depression in the vicinity of Citrusdal, which corresponds with an intersection of a NW and EW fault. The possible explanation is that there are open fault conditions here and flow is feeding into the fault. The area K may also flow into the same fault. An alternate explanation may be high abstraction in the area for irrigation creating the depressed water table locally.

The water level and flow behaviour in the sand aquifer was investigated to try to find evidence of fault feeding from the underlying TMG area (Figure 5.14). The premise was that if leakage did take place under the sand then there would be discharge areas with slightly elevated water levels along the fault zones. For better accuracy the holes selected were those with the closest cluster to get the best interpolations. There appear to be elevated water levels at A and C, which correspond very well with the topographic highs. The major EW fault and the projected NW one follow an erosional depression, with the latter along a palaeo-valley. There is no indication at this resolution that faults are feeding the aquifer anywhere along their length. The flow appears to be in all directions into the depression and then fans out as it approaches the coastal plain and gradients

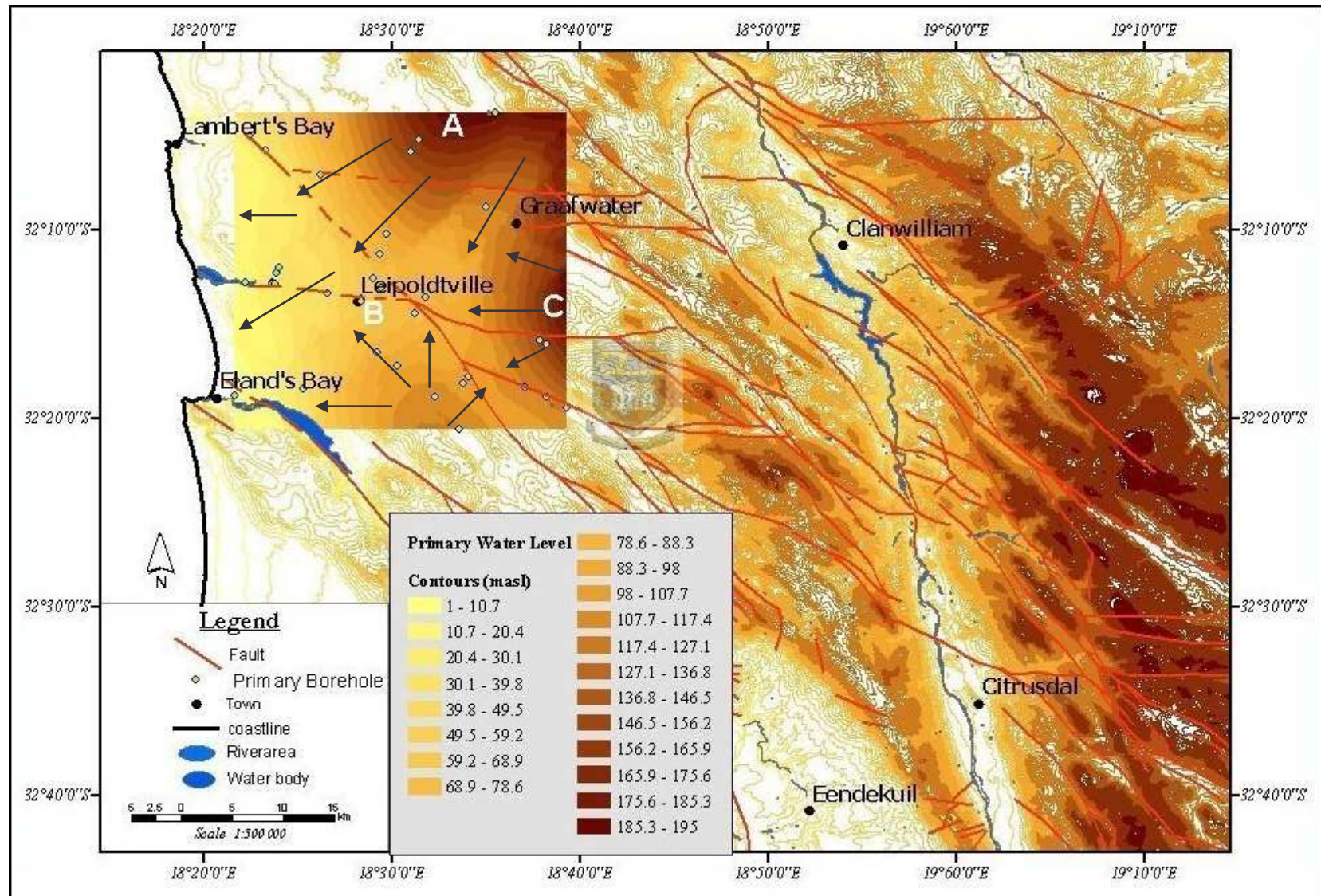

Figure 5.14 Water level contours for the Primary sand aquifer (using ordinary Kriging) Arrows indicate flow direction

become lower. A larger number of data points, and a larger scale plot of that data could be used to investigate this method further.

5.3.2 Water chemistry

Borehole chemical data of EC and pH for selected holes in the dataset were compiled. The data was again analysed using ordinary Kriging to ascertain if there was a noticeable relation with the major faults. Other chemistry data was not used as data sets were incomplete and verification and investigation of information would be required.

The EC data plotted for the study area is shown in Figure 5.15. There is a very wide spread of data points and the interpolations based on this seem not to show up any pattern that may be inferred as fault control. However there is a generalized increase in EC values westward with a peak in the northwest (B) from Graafwater to Lamberts Bay, with another one southwest (C) from Redelinghuys to Elands Bay. A lower EC band (A) between these highs may be influenced by the deflected flow along the dyke. The low EC trending NW (E) is probably due to the central mountains recharge and may indicate a possible response to the faults in this area. The expected lower values in the eastern mountains (D) due to high recharge, show a slight indication of bounding between faults. The higher values in the area SE of Clanwilliam is an anomaly that needs investigation as it is based on a single borehole analysis, and its extension northeastward (interpolated) shows the limitations of using a sparse data set for Kriging.

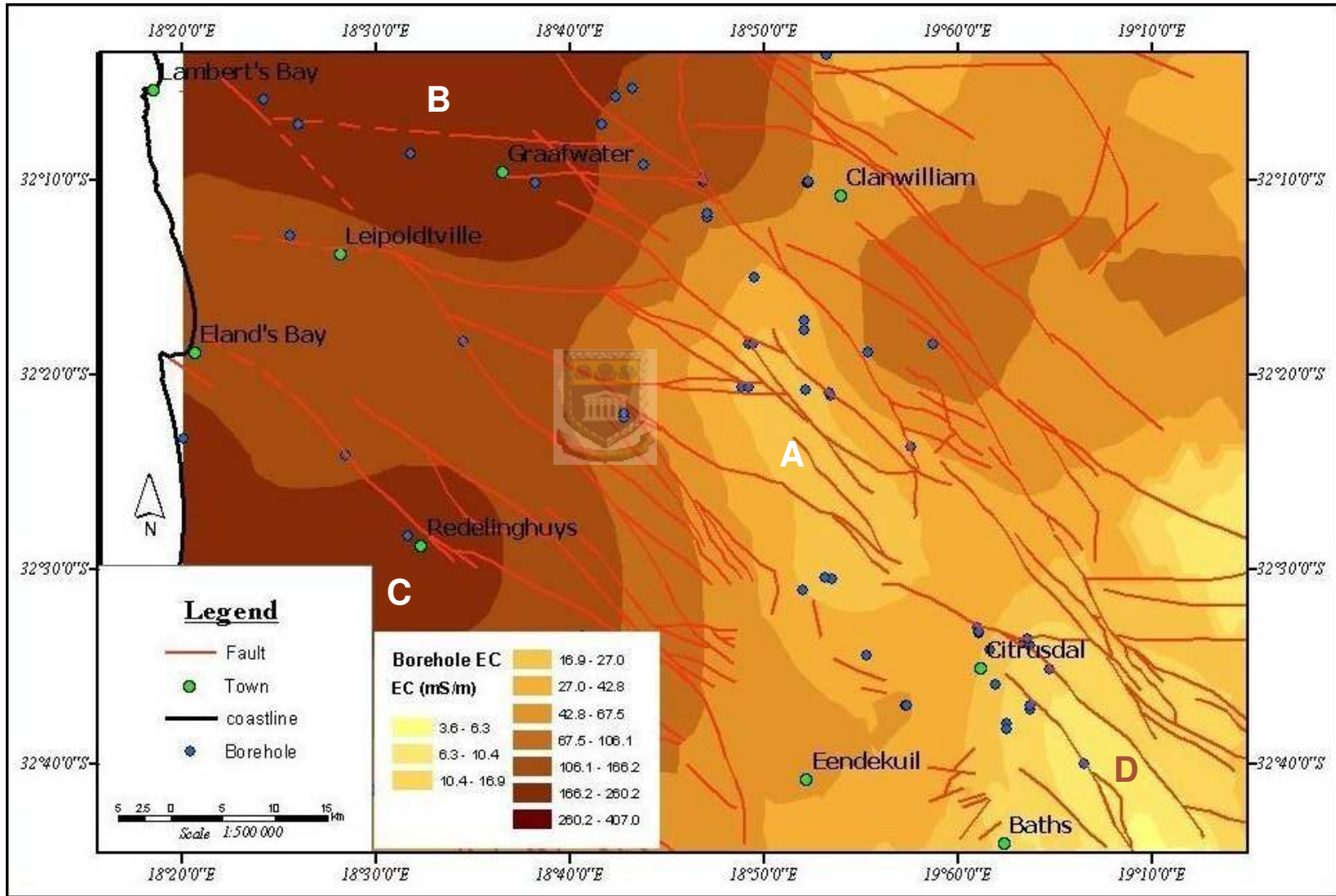

Figure5.15 EC value contours for the Secondary aquifer (using ordinary Kriging)

The pH data for the study area is shown in Figure 5.16. Data spread is again very wide with fewer data points in the south-west parts of the area. The ranges of pH for the TMG make it difficult to identify anomalous zones. The higher pH in the area around Lamberts Bay (A) may suggest deep flow discharge, possibly from the central mountains. Alternatively it could be a response to the intrusive volcanics underlying the area. The other high is at (B) where it seems faults bound it along the NW orientation. The extension of this area to the NE below Clanwilliam seems to be an error as there are no data points there. This could indicate a limitation of using the Kriging method with limited data points. The very low pH values in the extreme NE appear typical for TMG(C), as it is in the northern part of the Cederberg Range. This trend would have been expected in the whole of the eastern part of the map area, where the high recharge is taking place.

Despite the limitations of the method used for interpolation, it is still a useful way of relating data to conceptual models and can indicate relationships with structures or geology. A more comprehensive data base and closer spaced data points would greatly increase effectiveness and value of this method of presentation of data.

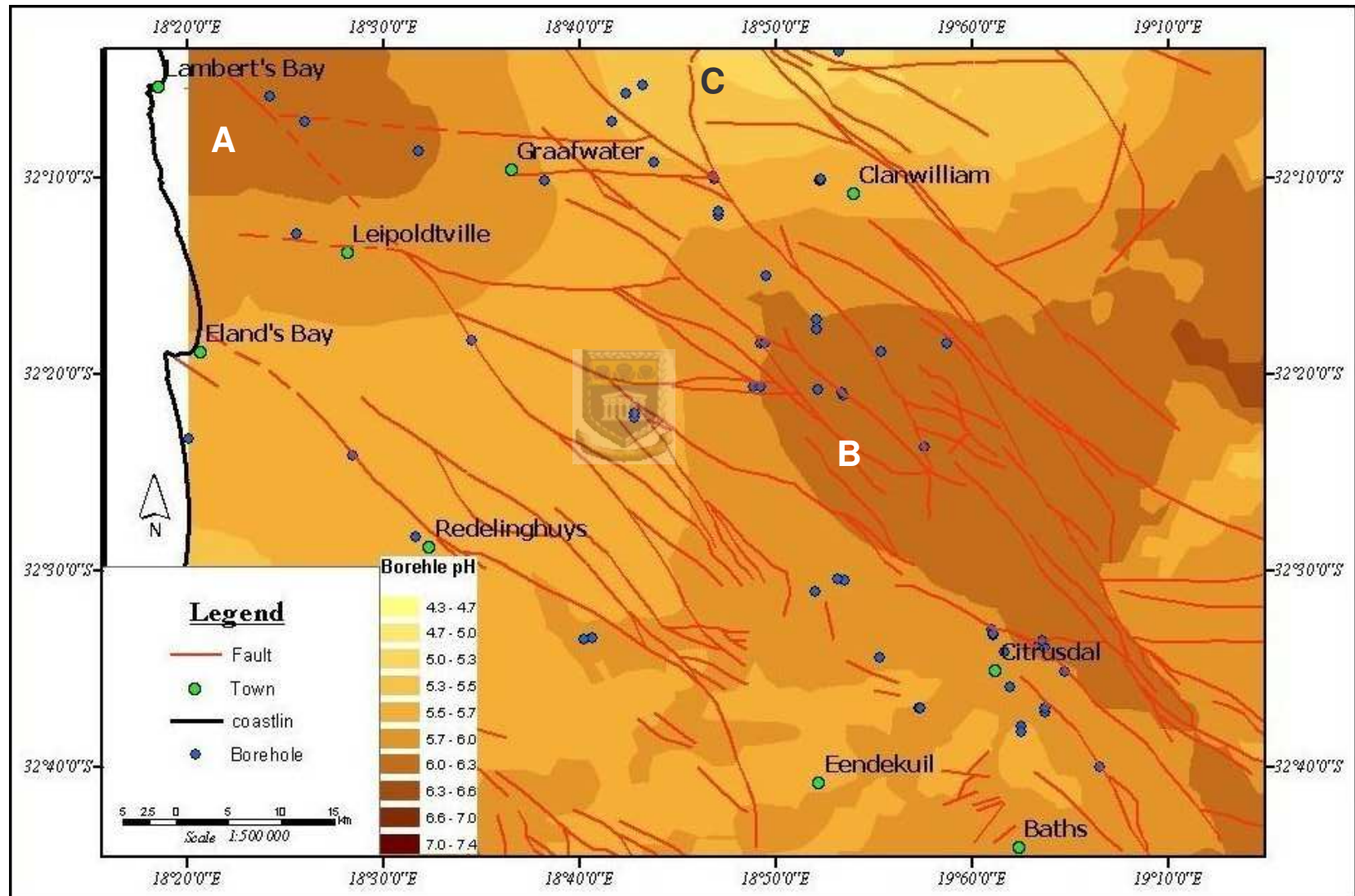

Figure 5.16 pH value contours for the Secondary aquifer (using ordinary Kriging)

5.3.3 Springs and wetlands

There are numerous perennial and seasonal streams in the study area. The former are important as they indicate the discharge areas at the end of the flow system. Most springs are lithologically controlled with issue points at contacts with the basement rocks or the Cederberg aquitard. A line of springs follows the Cederberg shale outcrop on the west limb of the ORS near Citrusdal, and another string of springs is found along the Piekenierskloof formation contact with the Klipheuwel formation west of Citrusdal. The position of the springs indicates lithological structure control on local flow.

The Baths thermal spring south of Citrusdal with a flow of around 30l/s and temperatures of ~43°C, is a deep groundwater discharge point. It is associated with a NE fault which cuts the west limb of the ORS and displaces the Cederberg shale by ~100m. The mechanism for flow of deep water is not understood, despite some isotope work done by Harris & Diamond, (2002). They attribute recharge to the spring by ambient rain water, with increase in temperature attributed to deep circulation. If recharge is from the east, then flow down the east limb could feed the spring on the west limb at a hydraulic boundary created by the Cederberg shale smeared along the NW fault.

Apart from the wetlands found in the Langvlei River which is groundwater fed (Nel, 2005); there are a few others that seem to follow large fault traces. The Verlorenvlei River consists of a series of vleis that follow the f9 fault all the way to the lake at Elands Bay. At the top of the Cederberg Pass along the f2 fault line is a wide vlei at an elevation of 1000m (figure 5.17a&b). The pictures are of the same view looking south down the valley.

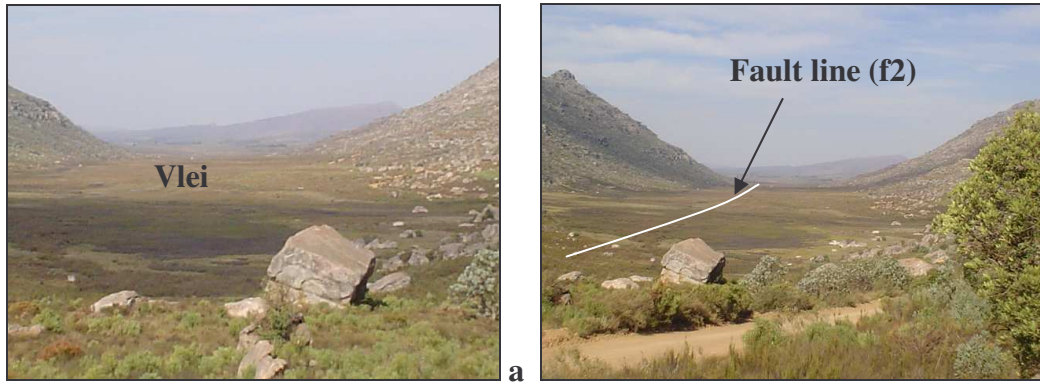

b

Figure 5.17a&b Mountain- top vleis in the Cederberg Pass.

In the upper reaches of the Langvlei river along fault f6 there are some vleis that appear to be associated with the Graafwater formation. In the Bergvallei River in the Langberg along the intersection of faults f7 and f7.2 there is a small wetland. These examples are used to illustrate the possibility of fault flow feeding the vleis or alternatively fault barriers creating elevated water levels which could then feed seeps at the surface. These may be cases to support the flow models proposed for the study area but further work is still needed to substantiate the evidence.

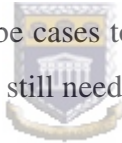

5.4 FLOW CONCEPTUALISATION

The 2 models proposed earlier to try to understand the flow pattern in the TMG part of the study area are discussed in relation to the evidence presented above. Although the reality is complex and varied, there are a number of generalizations that can be supported by the evidence.

In the models the role of fractures is important in controlling flow. From field and borehole information the importance of bedding and conjugate joints is clearly demonstrated as the dominant permeability in the aquifer rocks. Flow at all levels, local or deep will preferentially follow these joint sets (Figure 5.18).

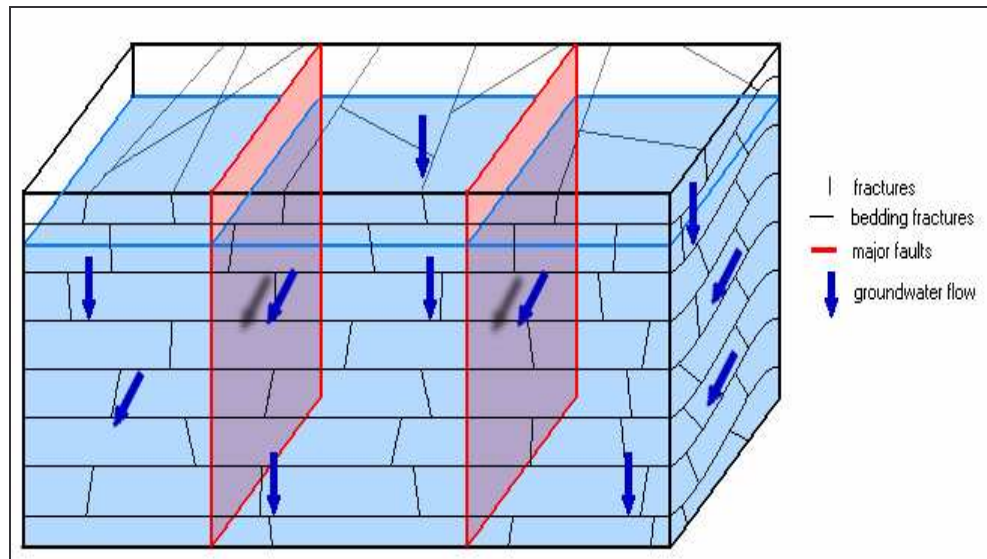

Figure 5.18 Conceptual flow in bedding and conjugate joints.

The importance of faults in the models has hinged on their being open conduits or sealed barriers to flow. From evidence of this study it would appear that the TMG faults display heterogeneity in terms of their permeability. It is therefore suggested that based on the field information some faults are open conduits to flow whilst others are sealed. This is further qualified by the possibility of the strike conditions of faults being variable, where permeability changes along a fault due to sealed or open zones. Those faults that are sealed or closed, may display varied levels of matrix permeability that allow low flow in porous cement, high fracture connectivity in the damage zone or open fissures. All of these could allow some horizontal flow on either side of the fault core.

The indications of water level variations close to or between faults in the fractured secondary aquifer support the block flow scenario. Here faults act as low permeability boundaries for flow that allow water levels to rise or fall according to the hydraulic head within discrete blocks. The predominant NW orientation of topography, faults and dykes show flow controls in the same direction in many parts of the aquifer.

Inter-catchment flow is taking place according to the conceptual flow models. The areas that show these transfers are indicated on Figure 5.19 which illustrates deep

regional flow. Structural controls are clearly shown in the cross sections already discussed influencing the inter catchment flow. There is flow from the eastern part of G30 feeding into the E10 in the region of the watershed line. Flow on the opposite side of the E10 shows flow into the E24 and E21 also below the watershed line or catchment boundary. The arrows (blue) on the eastern side indicate deep flow in the Krakadouwberg syncline. Arrows in purple indicate the flow within the Olifants river syncline. The white arrow shows flow direction in the Waterberg syncline, with limited flow out of the G30 catchment in the area of the red arrows. This generalized deep flow pattern is disrupted by the major faults, but their effect is not able to be shown as fault properties are not known for certain.

The models proposed can be applied to both upper and lower aquifers since the structures controlling flow are pervasive and extend to depth. Faults are deep, possibly upper crustal (Hartnady, 2002) and cut through the Cape Supergroup influencing both local and regional flow. Bedding and conjugate joints are persistent throughout the lithological units, and conditional on aperture size, will allow flow along them. Geological contacts and intrusive dyke barriers form low flow boundaries effectively controlling flow direction. Conceptualizing flow within the study area has shown the dynamics of the flow patterns, and the implications for development of the resource.

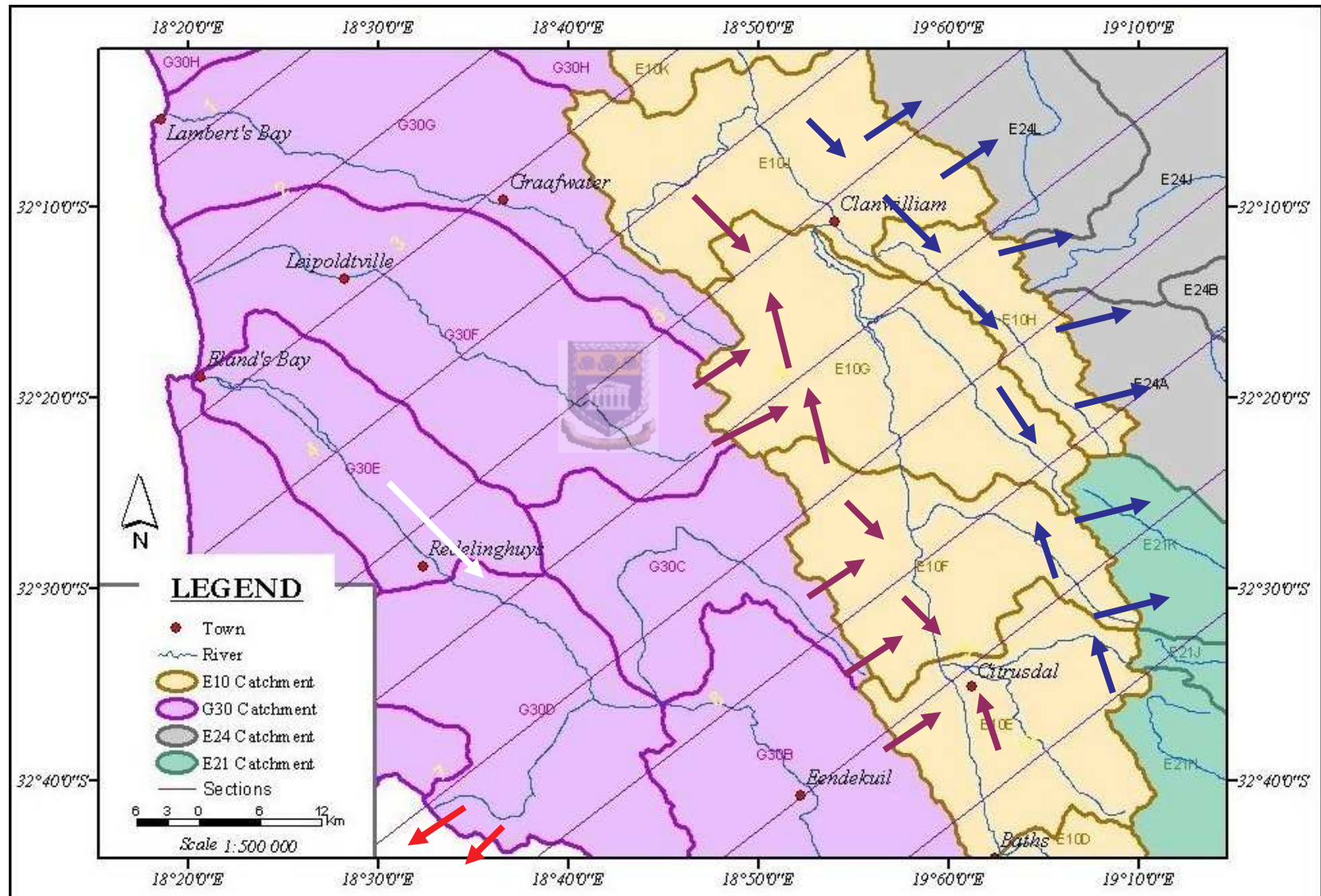

Figure 5.19 Inter catchment flow as indicated on cross sections (arrows show deep flow directions in the lower aquifer)

CHAPTER 6 -CONCLUSIONS AND RECOMMENDATIONS

6.1 SUMMARY

The uniqueness of the TMG due to the fortuitous combination of lithology, tectonics and climate is under-scored by the difficulties in interpreting its dynamics. A good understanding of its various components and their inter-relationships were achieved by the integration in this study of geology, structure, topography, physiography and hydrogeology.

Drawing on the various work and expert opinions on the different topics related to the study, a case was developed to support the method and approach adopted. The review of literature showed the different approaches that are used locally and in other parts of the world, indicating possibilities to develop new methods and ideas. The main outcome of the review was to support the integration approach, where available data can be applied in a multi faceted way.

The objectives have been achieved. The study identified the different types of structures, namely geological contacts, fold systems and faults and joints. It provided detailed descriptions of these features from remote sensing and field investigation, and went further to evaluate the effects and controls they have on groundwater flow in the study area. The construction of the geological cross sections developed the conceptual model to the extent that flow paths were able to be clearly delineated, and the dynamics of the system better portrayed. Where the structures were identified, interpretations were made of their effects and influence on flow. Various processes were shown to be taking place.

The problem question has been addressed by identifying the controls on flow in terms of structures. Having done this it was a logical step to show how the

different structures influenced flow, by acting as low permeability zones (barriers) or high permeability zones (conduits).

The methods adopted for the study were based on developing a good geological framework and understanding of the study area. This was done using techniques that developed detailed information, which was then used to interpret flow regimes. The area was studied by understanding its physiography, geology and hydrogeology and the way that these components interact.

The assessment of groundwater flow was the culmination of integrating all the evidence. Faults were seen to be heterogeneous in their hydraulic properties, and show different characteristics which may allow a classification to be done. This would allow similar fault types to be grouped, possibly in broad groups for example permeable or not. This would allow for application of modeling in blocks designated certain hydraulic properties. Geological structures such as the main aquitards have been shown to be crucial in aquifer separation with different flow patterns in the upper and lower systems. Dyke intrusions are looked at as hydraulic boundaries, contributing to compartmentalizing of the aquifers and creating unique, site specific flow conditions. Deep fold structures are regionally important in their flow control on a large scale. Not only do these structures generate very deep flow of >2500m, they also restrict flow to within it. For example the Olifants river syncline has a deep flow system separated from that of the Krakadouw syncline to the east. Flow along the strike of the folds is also very significant. Probably of greatest importance is the role of the joints, making up the predominant bedding planes and sets of interconnected conjugate joints. These have been shown to be persistent and pervasive throughout the study area, and their cumulative effect on flow is considerable.

Having developed the scenario from the structural perspective, it was necessary to apply data to test the hypotheses for flow. Using available water level data for the primary and secondary aquifers a contour plot was used to try to find patterns indicating flow controls. In the context of the conceptual models it was found that

there are noticeable trends in water levels which correlate with the fault structures, and that the regional trend (NW) is impacting on flow patterns. The data plots support the compartment or block theory, with some water levels conforming to these blocks. This lends credence to the discrete, structurally controlled flow of the conceptual models. The effects of structure on EC and pH plots also indicate some control but this would require more detailed investigation.

Whether a fault is open or closed, preferred flow will be in a northwest direction. The logic is that if the fault acts as a conduit it will direct flow in the path of the fault, and if it is closed or weakly permeable the flow will be along the side of the fault, hence the NW trend. It has been established from this study that there is no link between the major faults in the east of the Olifants River with those on the west. This invalidates the view that flow from the Cederberg mountains flows to the Sandveld and the sea. It would appear rather that the flow to the coast is from recharge in the middle mountains, such as the Swartberg, Langberg, Waterberg and the Uitskomsberg. If flow is along faults then it would be in a northwesterly direction either side of the Olifants River. This has implications for isotope studies which assume recharge from the east along the faults to the west.

The study of structures and their role in flow control has shown the importance of understanding the fundamental geological features of an area, before any hydrogeological work is done. The correct conceptual models will prove invaluable when collecting and interpreting data, and where new exploration or development is to take place.

6.2 MANAGEMENT IMPLICATIONS

The conceptual understanding of the structures and the impacts that they have on flow, both local and regional will influence the way that the resource is quantified and developed. In terms of resource estimation, the groundwater resource unit demarcation must be done within the parameters of the conceptual models which

will ensure that important hydrogeological factors are included. A GRU could be situated within a block with certain features such as a dyke or fault, whilst an adjacent GRU may show different characteristics. The flow conceptualization is important for understanding in- and out-flow processes, which impacts on the quantification of the resource. The impact of cross catchment flow is strategically a critical concern for management at Water Management Area (WMA) levels. Although this impacts on deep flow in the E10 catchment, it is important in the local flow of the G30 catchment. Recharge that is estimated for the G30, may actually be lost as local flow into the E10. If these quantities are allocated to the G30, there would be an over-estimation of resources.

The value of accurate data, and more so its interpretation, is crucial for decision making. There are huge amounts of data available, often on an ongoing basis which is under-utilised. In the hands of knowledgeable persons it can be even more productively used. Conceptualizing areas often can give new meaning to the way that available data is viewed and new data is collected. The importance of correct estimation of resources in order to meet the RDM requirements cannot be over emphasized.

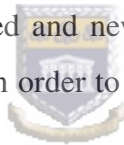

The development of new sources of water in terms of the National Water Act (1998) and the Water Services Act (1997) to meet present and future needs, is a priority for DWAF. With the focus shifting towards the developing of groundwater resources, it will become increasingly important to determine target areas. The TMG has been in the focus due to its great potential and the Clanwilliam area with its increasing demands for irrigation water has already been investigated for its development capacity. Access to the deep aquifer of the area would be a logical target for exploiting resources which would have the least impact on the environment due to its great depth. From the cross section views of the study area the E10 deep flow (lower aquifer) is where the greatest potential is for exploitation and development.

6.3 RECOMMENDATIONS

Based on the present study a number of areas for future and further investigation is suggested.

Fault zones need to be studied in more detail. The focus should be on classifying, categorizing and exploring faults by means of drilling, field mapping or trenching both across their width and along strike.

Using all available borehole data for selected areas within blocks or fault bounded zones, detailed investigation of water level and chemistry should be done to establish the impacts of the structures. Information not available on the data base can be obtained from private boreholes to increase the spread of data points to give more meaningful results. Plotting and contouring from this data will generate enhanced responses to the structures. It is also suggested that piezometers be installed in the monitoring boreholes to give hydraulic head data which will indicate better the flow directions (Van Tonder, 2005). A detailed contour map of water levels from very close spaced data points can be done based on the work of Bense et al (2003). Rainfall data for the block area could also be used i.e rainfall stations nearest the block, rather than average rainfall for the whole area. This could be used to investigate the water balance of a block and indicate responses (or not) to rainfall events.

Specialist analysis is needed of chemistry and isotope data that is available. In the context of the model being used, interpretation of data can be conceptualized. Errors in sampling and analysis should also be avoided by recommended sampling protocols being implemented. The information from such studies will be applied to the conceptual models to establish where and how groundwater flows.

The aerial magnetics that were done for the Sandveld study should be revisited and contextualized. Cheaper ground magnetics could be used to augment the available information and a geophysical map can be compiled to establish a detailed structural and hydrogeological map. The implications of flow controls by

intrusives and buried faults have been discussed already. This data needs to be applied in the hydrogeological context.

The advantage for future studies is the extensive existing data base and work that has already been done in this area. Building onto this and using different approaches could produce more meaningful results with practical applications for the relevant role players.



REFERENCES

Andreolli,M.A.G., Doucoure,M., Van Bever Donker,J., Brandt,D. and Anderson,N.J.B. (1996) Neotectonics of Southern Africa- a review. *Africa geo science review*, v 3, 1, p1-16.

Bense,V.F. & Van Balen,R.T. (2004) The effect of fault relay and clay smearing on groundwater flow patterns in the Lower Rhine Embayment. *Basin Research*, 16 , p 397-411.

Bense,V.F., Van Balen,R.T. and De Vries,J.J. (2003) The impact of faults on the Hydrogeological conditions in the Roer Valley Rift Valley System: an overview. *Netherlands Journal of Geosciences*, 82 (1),p 41-54.

Boelhouwers,J. (1999) Weathering effects at the Stadsaal Caves, Cederberg Mountains, Western Cape. Poster of field excursion to Cederberg Mountains, Earth Science department, University of the Western Cape.

BKS/ Ninham Shand (1998) Olifants/ Doring River basin study, water resource development options. Report for Department of Water Affairs and Forestry.

Booth,P.W.K. & Shone,R.W. (1999) Complex thrusting at Uniondale, eastern sector of the Cape Fold Belt,RSA: structural evidence for the need to revise the lithostratigraphy. *Journal of African Earth Science*, 29 , p 125-133.

Broquet,C. (1992) The sedimentary record of the Cape Supergroup: A review. *Inversion tectonics of the Cape Fold Belt,Karoo and Cretaceous basins of South Africa, de Wet and Ransome(Ed)*.

CCGR (2000) Co-ordinating Committee for Geohydrological Research, advisory body of the WRC, recommendations in minutes of meeting.

Doser,D. (2002) Characterizing fault control of groundwater using geophysical techniques. Research report for Geological Sciences, University of Texas in El Paso.

Evans,J.P., Forster,C.B., Goddard,J.V. (1997) Permeability of fault related rocks, and implications for hydraulic structure of fault zones. *Journal of Structural Geology*, v 19, p 1393-1404.

Fetter,A. (1988) Hydrogeology. Merrill

Freeze,R.A. & Cherry,J.A. (1979) Groundwater. Prentice Hall Inc.

Geoss (2004) Groundwater reserve determination required for the Sandveld Olifants/ Doring Water Management Area, Western Cape, South Africa. Report for Directorate Hydrogeology, Department of Water Affairs and Forestry.

Gudmundsson,A., Berg,S.S., Lyslo,K.B., Skurtveit,E. (2001) Fracture network and fluid transport in active fault zones. *Journal of structural geology*, 23, p 343-353.

Gudmundsson,A. (2001) Fluid overpressure and flow in fault zones: field measurement and models. *Tectonophysics*,336, p 183-197.

Hancock,P.L.& Engelder,T. (1989) Neotectonic joints. *Geological Society of America Bulletin*, V101, p 1197-1208.

Hardman,R.E.P & Booth,J.E. (1991) The significance of normal faults in the exploration and production of North Sea hydrocarbons. *Geometry of normal faults*, *Geological Society special publication* (56), Roberts,Yielding,Freeman (eds)

Harris,C.& Talma,A (2002) Application of Isotopes and hydrochemistry as exploration/ management tools. In *A synthesis of the hydrogeology of the Table Mountain Group-formation of a research strategy*, Pieterse&Parsons (Ed), WRC report No.TT158/01.

Harris,R.& Hay,E. (2002) Role of remote sensing in exploration for deep artesian groundwater in the Table Mountain Group. In *A synthesis of the hydrogeology of the Table Mountain Group-formation of a research strategy*, Pieterse&Parsons (Ed),WRC report No.TT158/01.

Hartnady,C.J.H.& Hay,E (2002) Fracture system and attribute studies in the Table Mountain Group groundwater target generation. In *A synthesis of the hydrogeology of the Table Mountain Group-formation of a research strategy*, Pieterse&Parsons (Ed), WRC report No.TT158/01.

Hartnady,C.& Hay,R. (2002) Use of structural geology/remote sensing in hydrogeological exploration of the Olifants/Doring river catchment. In *A synthesis of the hydrogeology of the Table Mountain Group-formation of a research strategy*, Pieterse&Parsons (Ed), WRC report No.TT158/01.

Jill Hammond,K.& Evans,J.P. (2002) Geochemistry, mineralization, structure and permeability of a normal fault zone, Casino Mine, Alligator Ridge district,north Central Nevada. *Journal of structural geology*,25 ,p717-736.

Khang,N.D, Watanabe,K., Saegusa,H.(2004) Fracture step structure: geometrical characterization and effects on fluid flow and breakthrough curve. *Engineering geology*, 75, p 107-127.

Kotze,J.C. & Xu,Y. (2003) Level of reserve determination required for the groundwater component- Olifants/ Doring catchment, Western Cape. *Report 5 of 8 for Department of Water Affairs and Forestry*.

- Macey,P.H. (1998) An introduction to the geology of the Western cape- some Gondwana sequences. *Proceedings of the Pan Gondwana conference, University of Cape Town.*
- Mazor,E. (1997) Chemical and Isotopic groundwater hydrology-the applied approach. Marcel Dekker.
- National Water Act (1998) Government Gazette of Republic of South Africa, Volume 398, number 19182.
- Nel,J. (2004) Assessment of the groundwater potential of the Langvlei Catchment. Draft report for Directorate hydrogeological services, Department of Water Affairs and Forestry.
- Nel,J. (2005) Assessment of Geohydrology of the Langvlei Catchment. Report GH4000, Directorate hydrogeological services, Department of Water Affairs and Forestry.
- Neuzil,C.E.& Tracy,J.V. (1981) Flow through fractures. *Water resource research*, v 17,1, p191-199.
- Newton,A.R.(1975) Structural applications of remote sensing in the Cape Province, and a new model for the evolution of the Cape Fold Belt. *Unpublished PhD thesis, University of Cape Town.*
- Parsons,R. (2002) Recharge of the Table Mountain Group aquifer systems. In *A synthesis of the hydrogeology of the Table Mountain Group-formation of a research strategy*, Pieterse&Parsons (Ed),WRC report No.TT158/01.
- Parsons & Associates (2005) Groundwater Resource Directed Measures – Pilot Study E10 Catchment Atlas. Part of GRDM Manual for WRC project K5/1427.
- Pieterse,K.& Parsons,R.(2002) Hydrogeological research needs and priorities for the Table Mountain Group Aquifer system. In: *A synthesis of the hydrogeology of the Table Mountain Group-formation of a research strategy*, Pieterse&Parsons (Ed),WRC report No.TT158/01.
- Pieterse,K.& Parsons,R. (2002) Need for appropriate research of the Table Mountain Group aquifer system. In *A synthesis of the hydrogeology of the Table Mountain Group-formation of a research strategy*, Pieterse&Parsons (Ed),WRC report No.TT158/01.
- Price,N.J. (1966) Fault and joint development in brittle/ semi brittle rock. Pergamon Press.
- Rasmussen,J.M (1998) An evaluation of the groundwater potential of 2 boreholes on the farm Malkoppa near Lamberts bay on the West Coast. Report for Toens and Partners.

Reid,D.L. (1998) Geology of Cape Peninsula. *Field guide for Pan Gondwana conference, University of Cape Town.*

Roberts,J.L. (1982) Geological maps and structures. Pergamon Press.

Rosewarne, P (2002) Hydrogeological characteristics of the Table Mountain Group aquifers. In *A synthesis of the hydrogeology of the Table Mountain Group-formation of a research strategy, Pieterse&Parsons (Ed)*,WRC report No.TT158/01.

Rust,I.C. (1967) On the sedimentation of the Table Mountain Group in the Western Cape Province. *Unpublished PhD thesis, University of Stellenbosch.*

Smart,M & Tredoux,G. (2002) Groundwater quality and fitness for use. In *A synthesis of the hydrogeology of the Table Mountain Group-formation of a research strategy, Pieterse&Parsons (Ed)*, WRC report No.TT158/01.

Titus,R., Adams,S., Xu,Y. (2002a) Groundwater situation assessment in the Olifants Doorn WMA (Version 1.0). Danced project of the Department of Water affairs and Forestry.

Titus,R., Adams,S., Wu,Y. (2002b) The Sandveld Core. Report for Directorate Hydrogeology, Department of Water Affairs and Forestry.

Umvoto/ SRK (2000) Reconnaissance investigation into the development and utilization of the Table Mountain Group artesian groundwater, using the E10 catchment as a pilot study area. CAGE project report for Department of Water Affairs and Forestry.

Van Tonder,G. (2005) Common errors hydrogeologists made when assessing groundwater flow systems: examples over 30 years. *Proceedings of the Ground Water Division conference, CSIR,Pretoria.*

Viljoen,J. (2004) Mapping report for the 1:50 000 sheets 3218 BA(Graafwater) and the 3218BC(Redelinghuys). Project 257, Council for Geoscience.

Visser,D.J.L. (1998) The geotectonic evolution of South Africa and offshore areas. Explanation of the structure map scale 1: 1000000, Council for Geoscience.

Visser,H.N & Theron,J.N. (1973) Geological series map 3218 Clanwilliam. Geological Survey, Department of Mines.

Wacker,S., Webersberger,S., Kgotlhang,L. and Kinzelbach,W. (2005) Modeling the fractured aquifer near Kanye, Botswana. Report for Swiss federal institute of technology, Zurich and Institute of hydro mechanics and water resource management.

Zenzile,B. (2002) Hydrogeological map of Calvinia. Department of Water Affairs and Forestry.

