

**DEVELOPMENT OF A SMALL-SCALE ELECTRO-CHLORINATION
SYSTEM FOR RURAL WATER SUPPLIES**

JULIAN DV KEY



A thesis submitted in partial fulfilment of the requirements
for the degree of Magister Scientiae, in the Department of Chemistry,
University of the Western Cape.

Supervisor: Prof. Vladimir M Linkov

October 2009

KEY WORDS

Electro-chlorination

Dosing system

Sodium hypochlorite

Water disinfection

Small-scale

Rural areas

Membrane electrolyser

Hypochlorous acid

Titanium

Cobalt oxide



ACKNOWLEDGMENTS

Mr Frikkie Joubert
(Worcester East Water Users Association)
Selection of research site

Mr Willie Naude
(Oude Wagon Drift Farm, Over Hex Crossing, Worcester)
Use of research pilot site

Mr. Alvin Peters
(Community member at Oude Wagon Drift Farm)
Participation and help

Mr Jeffery Nichols
(Electroparts, Parow, Cape Town)
Supply of solenoid valve system controls

Mr Peter Boon
(UWC electrical workshop)
Construction of electrical components and advice.

Prof. Vladimir M Linkov
(UWC chemistry department)
Supervisor

ABSTRACT

Title: Development of a small-scale electrochlorination system for rural water supplies
Author: JDV Key
Degree: MSc – thesis
Department: Chemistry
Institution: University of the Western Cape

To address the urgent need for safe potable water in South Africa's rural areas, sustainable systems for water disinfection at the village-scale of operation are required. In this thesis, the development of a small-scale water chlorination system that runs on salt and solar panels is described. The system combines a membrane-based hypochlorite generator, or "membrane electrolyser", with an automated hypochlorite dosing system.

The system was designed to (i) coordinate hypochlorite production and dosing automatically in a flow-through system, and (ii) fit inline with low pressure pipelines from overhead storage tanks or raised water sources. Low cost materials were used for construction, and water-powered mechanisms were devised to control both brine supply to the electrolyser and regulation of water flow. The capacity of the system was based on the maximum daily output of the electrolyser at ~20 g of sodium hypochlorite. This was sufficient to chlorinate up to 10 kL of water per day using less than 80 g of salt and less than 0.1 kW.h of electricity. The cost of the system was estimated at ~R10 000 and therefore potentially affordable for communities up to 100 people, e.g. small farms and villages.

Testing of the system was carried out at a farm site in Worcester (Western Cape) using remote monitoring of current levels in the electrolyser. Operation of the system over a two month test period, dosing at ~4 mg/L, produced consistent chlorination measured as (FAC). Community participation in maintenance of the brine supply was managed and chlorinated water was made available to the community after a brief social survey was conducted. Community awareness of chlorination was minimal. No significant history of diarrhoea was reported. However, the community regularly boiled their tap water in response to turbidity increase in summer.

The system was affected by turbidity increase in the local water, which caused a drop in electrolyser current and chlorine production due to particle blockage of the membrane in the electrolyser. However, turbidity at acceptable levels for chlorination was found to have no detrimental effect on the system's performance. The system showed promise for rural implementation providing low turbidity was maintained. Therefore, groundwater sites, and surface waters with appropriate clarification systems are recommended for the system's installation. Further testing of the system will be required to establish its long term viability in the hands of a rural community.

DECLARATION

“I declare that Development and Testing of a Small-scale Electro-chlorination System for Rural Water Supplies is my own work and that all the sources I have used or quoted have been indicated and acknowledged as complete references.”

Julian DV Key



Signed:

Date: October 2009

TABLE OF CONTENTS

TITLE PAGE.....	i
KEY WORDS.....	ii
ACKNOWLEDGMENTS.....	iii
ABSTRACT.....	iv
DECLARATION.....	v
TABLE OF CONTENTS.....	vi
LIST OF TABLES.....	x
LIST OF FIGURES.....	xi
LIST OF ABBREVIATIONS.....	xii
CHAPTER 1: INTRODUCTION.....	1
1.1 A RURAL WATER PROBLEM.....	1
1.2 HYPOCHLORITE: AN APPROPRIATE DISINFECTANT.....	1
1.3 ELECTROCHLORINATION: MAKING HYPOCHLORITE AVAILABLE.....	2
1.4 A SUSTAINABLE VILLAGE-SCALE WATER DISINFECTION SYSTEM.....	3
1.5 FOCUS OF THE THESIS.....	3
CHAPTER 2: LITERATURE REVIEW.....	4
2.1 ONSITE ELECTROCHLORINATION.....	4
2.1.1 Hypochlorite generators.....	5
2.1.2 Hypochlorite generators and water chlorination.....	5
2.1.3 Onsite electrochlorination running costs vs. purchased hypochlorite.....	6
2.2 REVIEW OF HYPOCHLORITE GENERATORS.....	7
2.2.1 Manual operation of “dip-type” hypochlorite generators.....	7
2.2.2 Saturated salt hypochlorite generators.....	9
2.2.3 Concentrated brine circulating generators.....	10
2.2.4 MIOX®.....	11
2.2.4 Package OSEC and hypochlorite dosing systems for smaller water supplies.....	11
2.3 HYPOCHLORITE PRODUCTION IN RURAL AREAS.....	13
2.3.1 Can OSEC be micromanaged by small communities?.....	13
2.3.2 Conclusions concerning OSEC at small rural sites.....	15
2.4 THE MEMBRANE ELECTROLYSER.....	16
2.4.1 How it works.....	16
2.4.2 Limiting factors of standard hypochlorite generators.....	19
2.4.3 Chlor-alkali cells (Divided electrolysis cells).....	20
2.4.4 The pH limiting effect of the membrane electrolyser.....	20
2.4.5 Comparison to MOGGOD.....	22
2.4.6 Cost comparisons and efficiencies.....	22
2.4.7 Membranes in brine electrolysis: pros and cons.....	23
2.4.8 Pros and cons of the membrane electrolyser.....	24
2.4.9 Conclusions concerning the membrane electrolyser.....	24
2.5 APPLICATIONS OF THE MEMBRANE ELECTROLYSER.....	25
2.5.1 Chlorination capacity of the membrane electrolyser based on a dosing range.....	25
2.5.2 Servable population size of the electrolyser.....	26

2.5.3 Potential applications for the membrane electrolyser based on chlorination capacity	28
2.5.4 Small-scale water disinfection (potential sites and considerations)	28
2.5.5 Small-scale chlorine residual boosting	29
2.6 IMPLEMENTING THE MEMBRANE ELECTROLYSER	30
2.6.1 Basic components a complete disinfection system	31
2.6.2 Minimum electrical power requirements and solar panels	31
2.6.3 Sodium hypochlorite dosing methods: costs and considerations	32
2.6.4	37
CHAPTER 3: AIMS AND OBJECTIVES.....	39
CHAPTER 4: RESEARCH METHODS.....	40
4.1 OPERATION OF THE ELECTROLYSER	40
4.1.1 Electrolyte supply	40
4.1.2 Power supply and current readings in the laboratory	41
4.2 ANALYTICAL METHODS	41
4.2.1 Chlorine (FAC) measurement	41
4.2.2 pH measurement	42
4.2.3 Turbidity measurement	42
4.3 CALCULATION OF FIGURES OF MERIT	42
4.3.1 Electrical energy	42
4.3.2 Salt consumption	44
4.3.3 Calculating Figures of merit in a batch reactor	45
CHAPTER 5: OPERATION AND TESTING OF THE MEMBRANE ELECTROLYSER	46
5.1 MODIFICATIONS TO ELECTROLYSER DESIGN	46
5.1.1 Redesign of top and base caps	46
5.2 DEVELOPING AN ELECTROLYTE SUPPLY SYSTEM	48
5.2.1 Problems concerning electrolyte supply	48
5.2.2 A batch supply system	49
5.2.3 Operation of the electrolyser as a batch reactor	49
5.2.4 Comparison of batch and plug flow supply methods	58
5.2.5 Conclusions	58
5.3 EVALUATION OF MEMBRANE FUNCTION.....	59
5.3.1 Construction of an undivided electrolyser.....	59
5.3.2 Conclusions	62
5.4 THE EFFECTS OF MEMBRANE BLOCKAGE.....	62
5.4.1 The membrane and turbidity.....	62
5.4.2 Recovery of the membrane.....	63
5.4.4 Conclusions	65
5.5 CONCLUSIONS TO CHAPTER 5.....	66
CHAPTER 6: DEVELOPMENT OF THE ELECTROCHLORINATION SYSTEM	67

6.1 DEVELOPMENT OF A BATCH DOSING SYSTEM	67
6.1.1 A water-powered brine batch	67
6.2.2 A complete batch dosing system	68
6.2.3 Solenoid valve specifications	71
6.2.4 Conclusions	72
6.3 TESTING THE BATCH DOSING SYSTEM	72
6.3.1 Control of water	72
6.3.2 Electrical current readings	73
6.3.3 Chlorine dosing	73
6.3.4 Electrical energy consumption	73
6.3.5 Inputs and outputs	74
6.3.6 Conclusions	75
6.4 CONSIDERATIONS FOR RURAL USE: SCOPE AND LIMITATIONS	75
6.4.1 Water pressure limitations	75
6.4.2 Chlorination level and dosing rate	76
6.4.3 Potential for community operation	76
7.5 CONCLUSIONS TO CHAPTER 6	78
CHAPTER 7: RURAL OPERATION OF THE SYSTEM	79
7.1 SITE SELECTION	79
7.1.1 The existing water source	81
7.2 INSTALLATION OF THE DISINFECTION SYSTEM	82
7.2.1 The Installation site	82
7.2.2 Housing	83
7.2.3 Water supply and chlorine contact time (CCT) system	83
7.2.3 Batch dosing system and brine supply	84
7.2.4 Power supply	87
7.2.5 Electrical equipment and remote monitoring	87
7.3 CONSIDERATION OF THE EXISTING WATER QUALITY	88
7.4 ESTABLISHING THE DISINFECTION SYSTEM AND REMOTE MONITORING	89
7.4.1 Determination of chlorine demand and filling the storage tank	89
7.4.2 Maintaining an acceptable chlorine residual in the storage tank	90
7.4.3 Current monitoring	90
7.5 CONSIDERATION OF THE COMMUNITY	91
7.5.1 Approach	92
7.5.2 Summary of findings from questionnaire	92
7.5.3 Discussion and major conclusions from the baseline survey	94
7.6 CONTINUOUS OPERATION OF THE DISINFECTION SYSTEM	96
7.6.1 Role of the community operator	96
7.6.2 Results of continuous operation	96
7.6.3 Discussion and conclusions from the continuous running period	98
7.7 PROBLEMS ARISING FROM INCREASED TURBIDITY	99
7.7.1 Adjustments to the filtration system	99
7.7.2 Effects of turbidity increase on the operation of the disinfection system	100
7.7.3 Impact of the summer and autumn shutdown of the disinfection system	101
7.8 FUTURE OF THE DISINFECTION SYSTEM AND THE PILOT SITE	101

7.8.1 Facilitating future community management of the disinfection system.....	102
7.8.2 Required modifications at the site	102
7.9 CONCLUSIONS TO THE PILOT STUDY	103
CHAPTER 8: CONCLUSIONS AND RECOMMENDATIONS	104
8.1 Capacity and cost of the disinfection system	104
8.2 Cost saving features of the disinfection system.....	105
8.3 Basic installation and operating requirements.....	105
8.4. Scope and limitations of the disinfection system	106
8.5 Conclusions from rural site operation:	107
8.6 Overall conclusions and recommendations:.....	107
8.7 Recommendations for future research.....	108
REFERENCES	109
APPENDIX 1: QUESTIONNAIRE	113
APPENDIX 2: HYPOCHLORITE AND CHLORINE.....	115



LIST OF TABLES

TABLE 2.1 SALT AND ENERGY EFFICIENCIES COMPARED	23
TABLE 2.2. CHLORINATION CAPACITY OF THE MEMBRANE ELECTROLYSER	25
TABLE 2.3. THIRD WORLD DOMESTIC WATER CONSUMPTION AND ACCESSIBILITY	27
TABLE 2.4. EFFECT OF WATER ACCESSIBILITY ON CONSUMPTION, AND SERVABLE POPULATION OF THE ELECTROLYSER	27
TABLE 2.5. GUIDELINES FOR THE SELECTION OF A WATER TREATMENT SYSTEM FOR SURFACE WATERS IN RURAL AREAS	29
TABLE 2.6. A TYPICAL SMALL PERISTALTIC DOSING PUMP	37
TABLE 5.2 BATCH SUPPLY VS. CONTINUOUS SUPPLY	58
TABLE 5.4 EFFECT OF TURBIDITY ON THE MEMBRANE ELECTROLYSER	64
TABLE 6.1. ELECTRICAL ENERGY CONSUMPTION OF THE BATCH DOSING SYSTEM	74
TABLE 6.2. INPUTS AND OUTPUTS OF THE BATCH DOSING SYSTEM	74
TABLE 7.1. OVERVIEW OF PROJECT SITE & PROJECT PERIOD	79
TABLE 7.3. CURRENT MONITORING OVER A TWO WEEK TEST PERIOD	91
TABLE 7.4 RESULTS OF CONTINUOUS OPERATION	97
TABLE 8.1 CAPACITY AND OPERATING CHARACTERISTICS OF THE DISINFECTION SYSTEM	104

UNIVERSITY of the
WESTERN CAPE

LIST OF FIGURES

Fig. 2.1 Envir-O-Cell 2.75®. Timer controlled hypochlorite generator manufactured in South Africa: A. The hypochlorite generator and rectifier, B. Schematic. Images reproduced with permission from GR solutions® (http://www.grsolutions.co.za)	8
Fig. 2.2 Biochlor saturated brine-fed hypochlorite generator.	9
Fig. 2.4 Over-head tank with OSEC and dosing system by Steriflo® model OHT-3L	12
Fig. 2.5 The membrane electrolyser as developed by Linkov (2002).....	18
Fig. 2.6 Schematic of brine electrolysis cells. A. Hypochlorite production in a hypochlorite generator (undivided cell), B. Chlorine gas production in a divided cell, and C. Hypochlorous acid production in the membrane electrolyser.	21
Fig. 2.7 Effect of pH on chlorine species in water	21
Fig. 2.8 Drip dosing of hypochlorite: Mariotte jar with shut off mechanism.....	34
Fig. 2.9 Water-driven hypochlorite dosing: Hollow-spoke wheel feeder.....	35
Fig. 2.10 Pressure-driven hypochlorite dosing: Venturi doser (adapted from Skinner, 2001).	36
Fig. 4.1 Plug flow electrolyte supply methods	41
Fig. 5.1 The membrane electrolyser. Top: schematic of horizontal cross section. Left: schematic of longitudinal cross section. Right: photograph showing pipe connections.	47
Fig. 5.2 Chlorine production vs. batch residence time.....	51
Fig. 5.3 Current vs. batch residence time	52
Fig. 5.4 Salt consumption (above) and material yield (below) vs. batch residence time	53
Fig. 5.5 Integral calculation of energy consumption from electrical power vs. batch residence time (using MS-Origin® software).	54
Fig. 5.6 Power and current efficiency vs. batch residence time.....	55
Fig. 5.7 Chlorine production (above) and current (below) vs. batch residence time	57
Fig. 5.8 The undivided electrolyser: developed as a possible alternative to the membrane electrolyser. ..	60
Fig. 5.9 Turbid water from the site. Left: After 5 days standing (~10 FNU). Right: fresh from the tap (~120 FNU).	64
Fig. 5.10 Membrane discoloration: Left: a new membrane as bought from the supplier. Right: a membrane cut to fit the electrolyser, showing staining after six months of use.	64
Fig. 6.1 A water-powered brine batch supply system. Left: photograph showing tube 3. Right: schematic diagram of the entire unit.	67
Fig. 6.2 A three-tank batch dosing system.	69
Fig. 6.3 The electrolyser's flush system. 1. Prior to flush. 2. Flushing.	70
Fig. 6.4 Float valve delay mechanism.	71
Fig. 7.1 Satellite image (~20.3 km altitude) showing the WEWUSA water supply system and project site.	80
Fig. 7.2 Existing disc filtration system on the farm.	81
Fig. 7.3 Community households on the farm.	81
Fig. 7.4 Schematic plan views of site. A. Eye level view. B. Overhead view showing existing pipelines and those of the disinfection system with two taps.	83
Fig. 7.5 Outside the shed. A: Housing of the disinfection system and existing community water tank. B: Chlorine contact time coil (75 L) and the chlorinated water storage tank (1000 L).....	85
Fig. 7.7 Schematic layout of the disinfection system.....	86
Fig. 7.8. Electrical equipment. A: SSE® remote monitoring box. B: Schematic of components.....	87
Fig. 7.9 The ANJET F50 disc filter that replaced the sand filter.	100

LIST OF ABBREVIATIONS

CCT	Chlorine contact time
COTA	Cobalt oxide/titanium anodes
DMTA	Dioxide of manganese/ titanium anodes
DEAT	Department of environment and tourism
DWAF	Department of water affairs and forestry
DSA	Dimensionally stable anode
FAC	Free available chlorine
FNU	Formazin nephelometric unit
MIOX®	Mixed oxidants generating system
MOGGOD	Mixed oxidant gas generated onsite for disinfection
NTU	Nephelometric turbidity unit
OSEC	Onsite electrochlorination
POE	Point of entry
POU	Point of use
ROTA	Ruthenium oxide/titanium anodes
SAIAMC	South African institute for advanced material chemistry
SWTPs	Small water treatment plants
THM	Trihalomethane
UWC	University of the Western Cape
WEWUSA	Worcester East Water Users Association

CHAPTER 1

INTRODUCTION

1.1 A RURAL WATER PROBLEM

An estimated five million people rely on untreated drinking water in South Africa's rural areas (DEAT, 2008). A large portion of this figure is represented by villages, small farms and informal settlements that are widely distributed within the country. The communities are often small (less than 100 people) and use water from "informal" sources (e.g. streams, rivers, small dams and boreholes), and in many cases have long managed to safely use such water without the need for water treatment.

However, within the past ten years, a visible presence of waterborne disease in rural areas has emerged, with recent outbreaks of cholera in Limpopo and Kwa-Zulu Natal making headline news (Mail and Guardian, 2007-2008). The outbreaks stem from sewage contamination of rural watersheds and the direct use of untreated contaminated water for drinking (Said, 2006).

To address this problem, there is concerted effort by government to build more water treatment plants and improve sanitation management in rural areas (DWAF, 2003). However, since rural communities are numerous and widely distributed, pipeline supply from centralized water treatment plants is a slow and expensive process, especially where pipelines need to cover large distances to reach small isolated communities. In the absence of pipe lines, interim measures are urgently needed to provide small rural communities with safe potable water.

1.2 HYPOCHLORITE: AN APPROPRIATE DISINFECTANT

One solution to the above problem is for small communities to manage the treatment of their local water supplies. This requires an effective water disinfection method that is both affordable and manageable on a village-scale.

Dosing water with hypochlorite (either as liquid sodium hypochlorite, “bleach”, or as solid calcium hypochlorite e.g. “HTH”: high test hypochlorite) offers such a method, and is successful in a wide variety of rural water disinfection schemes.

Village-scale schemes, range from short term emergency applications, which are manual in operation (e.g. dosing of water by hand at the household level) to more sustainable dosing regimes that employ affordable mechanisms to dose hypochlorite automatically into a shared water supply (Skinner, 2001). Clearly the latter application is favourable because: (i) it is less labour intensive, and (ii) it ensures that all members of the community receive disinfected water.

However, hypochlorite is often not available in rural areas and it can be costly to import (Skinner, 2001). Furthermore, it can degrade in storage over a matter of months (Burch and Thomas, 1998 and Gordon *et al.*, 1997) therefore unless there is a fresh regular supply hypochlorite dosing is not an option.

1.3 ELECTROCHLORINATION: MAKING HYPOCHLORITE AVAILABLE

The use of an onsite hypochlorite generator can provide a regular supply of fresh sodium hypochlorite. The process is known as OSEC (onsite electrochlorination) and generates sodium hypochlorite through the electrolysis of brine. Hypochlorite generators require the inputs of electricity and common salt, and when using solar panels become highly cost effective and sustainable (Pearson, 2000 and Skinner, 2001). This is because salt is commonly available, cheap, and stores indefinitely.

The generators produce a hypochlorite solution close to 10 g/L or 1% chlorine, which is ideal for water chlorination and stores longer than higher concentration commercially-produced bleach (Gordon *et al.*, 1997). Furthermore, hypochlorite generators for village-scale operation are affordable and have been successfully implemented in developing countries for emergency water disinfection programs (e.g. CDC-safe-water, UNICEF-WASH, and Safe Water International).

1.4 A SUSTAINABLE VILLAGE-SCALE WATER DISINFECTION SYSTEM

Hypochlorite generators appear an excellent means for facilitating the use of hypochlorite in rural areas. Therefore, if used in combination with an affordable automated hypochlorite dosing system, a sustainable village-scale water disinfection system could be formed. Such systems are well represented at a larger scale in small water treatment plants, but examples at the village-scale of operation are seemingly rare. Nevertheless, since both components of the system have been successfully managed separately on a village-scale, there appears to be no obvious reason for not implementing them together.

1.5 FOCUS OF THE THESIS

In this thesis the above possibility is addressed, and a system combining a small-scale hypochlorite generator and an automated dosing system is developed. The hypochlorite generator was previously developed by Linkov (2002) and Siguba (2004), and includes a membrane that allows energy efficient production of sodium hypochlorite. The implementation of this “membrane electrolyser” represents the central research question of the thesis, which is:

- *Can the electrolyser in combination with an affordable automated dosing method provide a viable, village-scale, water disinfection system?*

And, more specifically:

- Can the membrane electrolyser produce a consistent concentration of sodium hypochlorite for dosing on a sustainable basis?
- Can a system be developed to control the electrolyser and dosing that is affordable, manageable and reliable?
- Can such a system be maintained and managed by a small rural community?
- What kinds of water sources and communities are most appropriate for its implementation?

CHAPTER 2

LITERATURE REVIEW

The following literature review gives an overview of onsite hypochlorite production (section 2.1) followed by a review on hypochlorite generators (section 2.2) and their feasibility in rural areas (section 2.3). This is followed by a description of the membrane electrolyser (section 2.4) and considerations for its use at rural water sources (section 2.5-2.6).

2.1 ONSITE ELECTROCHLORINATION

Onsite electrochlorination (OSEC) produces chlorine onsite using brine electrolysis. Brine electrolysis requires two inputs: brine (NaCl + water) and electricity. The process is carried out in an electrolytic cell (or electrolyser) in which DC-powered electrodes (usually 2-4 V) drive the conversion of brine to chlorine (see below).

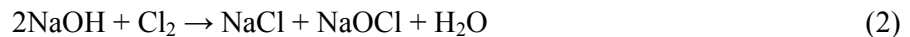
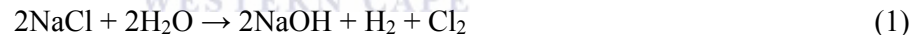

Depending on the design, they can produce chlorine either as a gas, or in the hydrolyzed form of hypochlorite (OCl⁻): forming sodium hypochlorite (NaOCl) otherwise known as bleach. Cell designs that produce chlorine gas, owing to the dangers, are mostly restricted to large centralized operations e.g. chlor-alkali plants. On the other hand, cells that produce hypochlorite can be much smaller and safer, requiring minimal expertise and basic safety precautions (White, 1999:183), and are therefore also suited to much smaller on-site operations.

2.1.1 Hypochlorite generators

Hypochlorite generators are electrolytic cells that produce sodium hypochlorite. Hypochlorite is formed because the products of electrolysis formed at the anode and cathode (i.e. molecular chlorine and the hydroxide ion (OH⁻) respectively) are free to mix and form hypochlorite (OCl⁻) (reaction 2). However, inherent limitations in the process (section 2.4) limit production concentrations to no higher than ~10 g/L or ~1% chlorine (Wallace & Tiernan OSEC® 2002). This is in contrast to the higher concentrations found in household and industrial-strength bleach (e.g. ~30 and 150 g/L respectively) that are produced by mixing chlorine gas and caustic soda (NaOH) that are formed separately in chlor-alkali cells.

2.1.2 Hypochlorite generators and water chlorination

The ~1% chlorine concentration of sodium hypochlorite produced by hypochlorite generators is ideal for water chlorination. Higher concentrations of hypochlorite in commercial bleach decompose to chlorate, a toxic by-product (Gordon *et al.*, 1997). However, even at ~1% chlorine, sodium hypochlorite solutions should be adjusted to pH 11-13 with NaOH, and not stored longer than a month. Therefore, water chlorination sites that use sodium hypochlorite have the following options:

- (i) To regularly buy high-strength sodium hypochlorite and use it immediately
- (ii) To periodically buy high-strength sodium hypochlorite and dilute it for on-site storage
- (iii) To buy low-strength sodium hypochlorite, or...
- (iv) To produce low-strength sodium hypochlorite onsite using a hypochlorite generator

The most suitable option for a given site is a question of cost and availability. The choice of onsite hypochlorite generation would be suited to the following conditions:

- Where sodium hypochlorite is expensive to buy or obtain.
- Where sodium hypochlorite cannot be obtained regularly or easily.
- Where dilute sodium hypochlorite cannot be suitably stored (e.g. limited storage space, unsuitable storage conditions, and safety reasons).
- Where electricity is inexpensive (e.g. existing solar powered installations).
- Where a regular and dedicated operator is available.

2.1.3 Onsite electrochlorination running costs vs. purchased hypochlorite

The running costs of hypochlorite generation are considerably cheaper than buying commercially produced bleach (see below). However, these must be weighed against capital cost of equipment (section 2.2) and maintenance of the technology (sections 2.3 and 2.6).

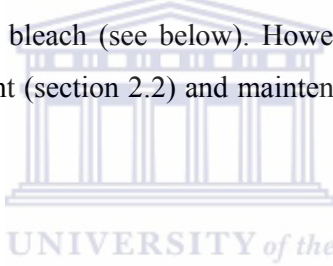

Hypochlorite dosing

Cost of sodium hypochlorite (~100 g/L chlorine): R4.68/L*:	R46.8 /kg Cl ₂
Cost of calcium hypochlorite (68% Cl ₂): R16/kg*:	R23.53 /kg Cl ₂

* As delivered inc. VAT, (sourced from Momba *et al.*, 2008)

Hypochlorite production

Cost of coarse salt: R2 /kg*:	4 kg (NaCl) / kg Cl ₂ :	R8 /kg Cl ₂
Electricity: ~4 kWh/kg Cl ₂ :	Mains: ~30 c / kWh*:	R1.20 /kg Cl ₂
Total:		<u>R 9.20 /kg Cl₂</u>

* Cost of salt R/kg variable according to bulk (coarse salt cheapest, but must be minimum 95% NaCl)

* ESKOM. Tariff restructuring plan 2008/9 (<http://www.eskom.co.za/tariffs>.)

2.2 REVIEW OF HYPOCHLORITE GENERATORS

Hypochlorite generators range from small handheld units for hikers (e.g. the MSR MIOX® Purifier Pen) to large fully automated systems used in water treatment plants (e.g. Wallace & Tiernan OSEC® systems). The cost of hypochlorite generators is determined by their size, type of anode material used, and by their level of electrical automation. Often patented or proprietary, dimensionally stable anodes (DSAs) are made of titanium metal with expensive platinum and catalytic oxide coatings that aid chlorine production and prevent anode corrosion (Pletcher, 1982; White, 1999).

2.2.1 Manual operation of “dip-type” hypochlorite generators

Manually operated hypochlorite generators are simple and inexpensive. The process requires a container with a fixed volume of brine of known concentration (usually ~30 g/L of NaCl) into which the electrodes of the generator are immersed and left for electrolysis to run over a fixed time and voltage (usually 2-4 V DC). The resultant hypochlorite (max. 10 g/L Cl₂) can then be safely stored in containers and later used for dosing water.

The power source, if using mains electricity, requires a rectifier for DC output. The main equipment costs of manual systems are therefore determined by the size of the hypochlorite generator, rectifier, or, solar power equipment.

In South Africa, a locally manufactured model, the *Envir-O-Cell 2.75®, includes a timer, display panel and a rectifier, distributed by GR Solutions (Fig. 2.1). The stated hypochlorite output of the system is 2.75 kg Cl₂ /day (enough to chlorinate 2.75 ML of water/day at 1 mg/L Cl₂) and the input 15 kWh/day and ~15 kg of salt. The cost of the Envir-O-Cell 2.75® unit is approximately ~R50 000 (personal communication with GR solutions, 2009).

*Envir-O-Cell 2.75® (http://www.grsolutions.co.za/sodium_hypochlorite_generator.htm).

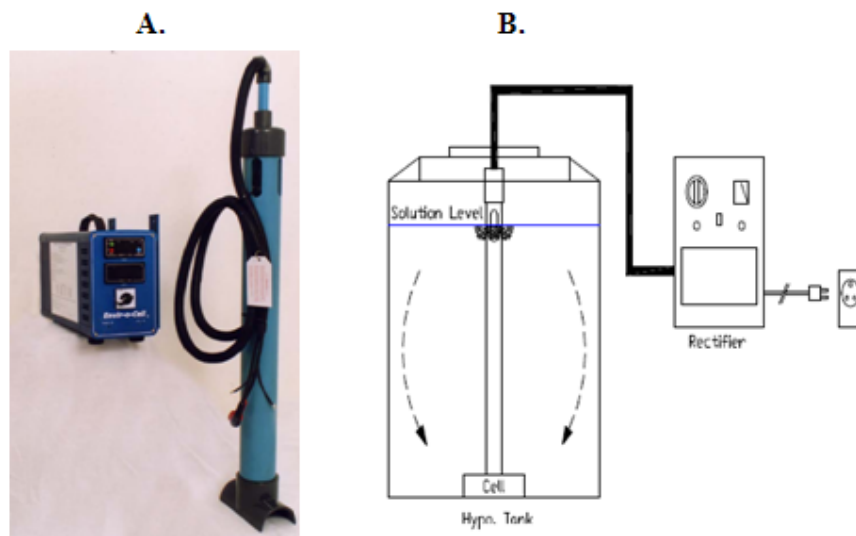

Fig. 2.1 Envir-O-Cell 2.75®. Timer controlled hypochlorite generator manufactured in South Africa: A. The hypochlorite generator and rectifier, B. Schematic. Images reproduced with permission from GR solutions® (<http://www.grsolutions.co.za>)

Smaller manual models are available internationally that produce less than 50 g of Cl_2 per day (for water volumes under 50 kL) from companies such as *Aquachlor® and *WatAyls®. The operating principle is essentially the same for these cells as the Envir-O-Cell 2.75®, and owing to their smaller size they are often marketed as a package including small solar panels, ideal for emergency water treatment in poverty stricken rural areas (also see: CDC (2008).

*Aquachlor® : (<http://www.equipmentandsystems.com/>),

*WatAyls® : (www.bulane.com)

- The advantages of manual systems are: (i) they are relatively cheap and (ii) require electricity only for brine electrolysis (not electrical pumps and controls).
- The disadvantages of manual systems are: (i) they are fairly labor intensive (compared to automated systems) and (ii) require a regular and dedicated operator.

2.2.2 Saturated salt hypochlorite generators

A South African company, Biochlor®, manufacture hypochlorite generators that use a novel non-electrical saturated brine supply system. Here, instead of having to mix brine to a standard concentration, the operator tops up a dry salt level in a saturation tank, which pools saturated brine at its base. The saturated brine is gravity fed into water to provide a concentration of ~30 g/L, which collects in the hypochlorite generator (Fig. 2.2).

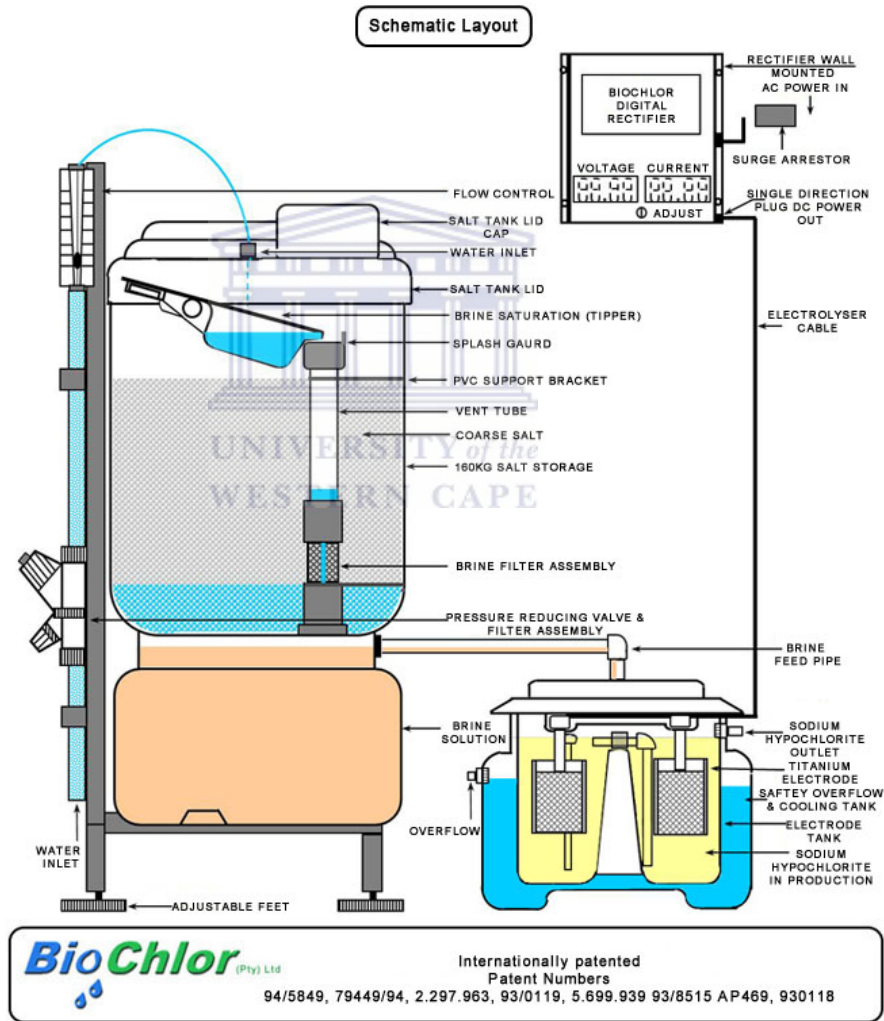

Fig. 2.2 Biochlor saturated brine-fed hypochlorite generator. Image reproduced with permission from Biochlor® (<http://www.biochlor.co.za/>)

The automated brine supply system, being non-electrical, is ideal for rural usage since solar panel size can be limited to powering just the hypochlorite generator. The components shown in Fig. 2.2 depict the hypochlorite generator running on mains electricity via a rectifier for DC output. The hypochlorite generator has an adjustable chlorine output of 0.2-5.0 kg Cl₂/day, sufficient to dose 0.2-5 ML of water per day at 1 mg/L of chlorine, and has a power consumption of ~3.8 kWh/kg of Cl₂ produced. The unit can produce hypochlorite continuously, which accumulates in a dose feeding tank. The use of two such Biochlor® units at small water treatment sites in South Africa is reviewed by Pearson, (2000).

The depicted system (Fig. 2.2) costs ~R20 000 (communication with Biochlor® in 2009) depending on the degree of additional equipment required at a particular site e.g. dosing equipment etc. The units are also modular and when assembled as such can collectively produce up to 200 kg of chlorine per day.

Biochlor® also produces smaller hypochlorite generators for chlorinating less than 15 kL of water per day, and these units can be powered by alternative energy sources such as solar power and small wind powered turbines. However, such units have only been implemented for manual operation (Personal communication with Biochlor® in 2009).

2.2.3 Concentrated brine circulating generators

Another South African company, Aquarius chlorinators®, produces hypochlorite generators that run on a circulating brine supply. The company makes a broad size range of generators (producing 0.16-32.0 L/h of 0.8% HOCl solution) that operate via a continuously pumped re-circulating brine supply through the cell. Once the maximum 0.8% chlorine concentration is reached (based on a timer mechanism) the hypochlorite is fed to a storage tank for dosing water. In general, the company focuses on larger scale potable water treatment operations exceeding 1 ML of water treatment per day, and based on the generator's requirement for circulation, i.e. electrical pumps, the system's retail within a similar price range as the above mentioned Biochlor® units. Successful

rural operation of the generators in water treatment has also been reviewed in the WRC report by Pearson (2000).

2.2.4 MIOX®

MIOX® is a USA-based company that produce a variety of water disinfection systems based on the electrolysis of brine. Some of these systems are highly automated comprising: electrical pumps; liquid level sensors in tanks to determine when brine should be pumped to the hypochlorite generator and when to power up the hypochlorite generator. An example of such a system is the HYPO-10, which is stated to produce about 4.5 kg of Cl₂ /day, enough to dose 4.5 ML of water at 1 mg/L Cl₂ (Fig. 2.3). At present MIOX® systems are not readily available in South Africa and due to their high degree of automation are more expensive than locally made systems, and models such as the HYPO-10 retail at well over R50 000.

MIOX® also makes systems that produce a dilute chlorine-based “mixed oxidant” disinfectant used in much the same way as hypochlorite. The essential difference is that a much more dilute brine solution is used at higher electrolysis voltages and the product although containing less free available chlorine (FAC) has been reported to have comparable disinfectant strength to that of higher chlorine concentration solutions. One of their smallest “mixed oxidant” units, the SAL-40, produces 1.8 kg of Cl₂/day, enough to disinfect, as stated 1.8 ML/day (at 1 mg/L Cl₂), but presumably with greater disinfecting power than just the stated chlorine content.

2.2.4 Package OSEC and hypochlorite dosing systems for smaller water supplies

The combination of a hypochlorite generator plus automatic dosing system to supply communities of 100-200 people is rare. This seems to indicate that the costs for automatic dosing at small water systems are inhibitive. However, IEC Fabchem Ltd., based in India, advertises a package system to this scale.

The model, Steriflo® OHT (overhead tank) - 3L, produces 30 g of Cl₂/day and doses the hypochlorite to the outlet pipe from of an overhead tank using a Venturi eductor and

small booster pump (Fig. 2.4). The operation of the hypochlorite generator is manual in the sense that: (i) brine is mixed by hand in a separate vessel and poured into the generator and (ii) that the generator is switched on and off manually after 22 h of electrolysis time. The system is stated to chlorinate 15 kL of water/day. The entire system is neatly and safely packaged in a small weatherproof housing.

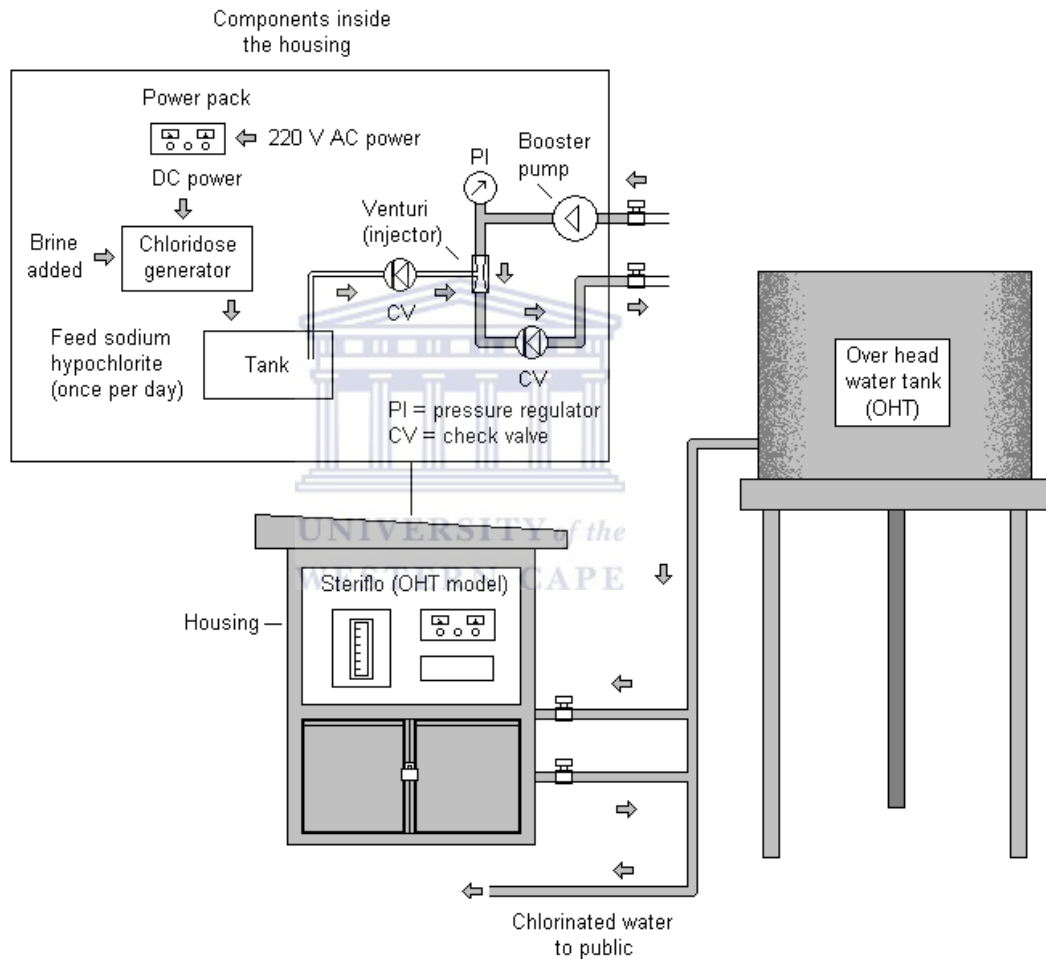

Fig. 2.4 Over-head tank with OSEC and dosing system by Steriflo® model OHT-3L (schematic adapted from: <http://www.iecfabchem.in>)

The above system, particularly if adapted to run on solar panels, would be ideal for rural areas in South Africa that have supply tanks fed by small water treatment plants because the water in such tanks often loses its chlorine residual (Momba *et al.*, 2008).

2.3 HYPOCHLORITE PRODUCTION IN RURAL AREAS

Hypochlorite generators are ideal for small-water treatment plants in rural areas because transportation of commercially produced sodium hypochlorite can become costly, inconvenient, and sometimes hazardous. Therefore, the use of salt (being cheap and indefinitely storable) and mains electricity (or solar panels) becomes a sustainable option. Once running, and beyond the returns from the initial investment (solar equipment, hypochlorite generator etc.), such plants can operate sustainably at very low running costs (e.g. the cost of salt, maintenance and labor) and can become the cheapest of all to operate (Solsona and Pearson, 1995; Pearson, 2000).

2.3.1 Can OSEC be micromanaged by small communities?

Small communities of less than 200 people are common in South Africa's rural areas. Hypochlorination at such sites might need to cater for up to 30 kL of water/day, which depending on the dosing requirements (i.e. the chlorine demand of the water) could range from 30-200 g of Cl₂/day. If the community is to manage its own water chlorination the following questions might be asked:

- (i) Does the community have access to fresh commercially produced hypochlorite at least once a month?
- (ii) Can the community afford to buy commercially produced hypochlorite at least once a month?

E.g. for 200 people using 30 kL/day of water at 150 L/person in 2009: Bleach costs R46/kg Cl₂ so at 200 g/day: $46 \times 200 \text{ g} / 1,000 \times 30 \text{ days} = \sim \mathbf{R270 / month}$

or R1.35 /person/month or 66 c/person/month if using HTH (see 2.14)

Total: 60 L of bleach per month or 9 kg of HTH per month

- (iii) Can the community provide reliable operators for the chlorination system?
- (iv) Can the community/municipality afford the chlorination system?

When the answer to all the above questions is yes, then a hypochlorite dosing system should be installed using commercially produced hypochlorite. This is because the use of commercial hypochlorite is easier to manage than including a hypochlorite production step. The system would require a dosing method for sodium hypochlorite (section 2.5), or an appropriate method for calcium hypochlorite dosing (Henderson *et al.*, 2005).

When the answer to questions (i) and (ii) is no, and (iii) and (iv) is yes, then a small-scale OSEC system becomes an appropriate possibility. Where this is the case, the following questions might be asked:

(v) Can the community afford to buy salt?

E.g. for 200 people using 30 kL/day of water at 150 L/person in 2009:

Chlorine from salt is ~5× cheaper than bleach: ~R54 / month

or 27c / person /month (section 2.14)

Total amount of salt: 24 kg/month

UNIVERSITY of the
WESTERN CAPE

Note: this calculation considers using mains electricity. If using solar, multiply the values by 0.8 to remove the running cost of electricity (section 2.1.3)

(vi) Will the community use mains electricity or solar panels provided with the system?

E.g. for 200 people using 30 kL/day of water at 150 L/person in 2009:

Communities using mains electricity will pay R7.2/month collectively (section 2.1.4)

If the community cannot afford to buy the salt, then deliveries from the municipality might be required: at no great cost (e.g. R54/month). If the community uses mains electricity but cannot afford the electricity cost (R7.2/month) something may be amiss. Questions (iii) and (iv) above are interrelated. Clearly manually operated OSEC systems are cheaper than automated ones (section 2.2), but require more maintenance and

community involvement. Therefore, the chosen OSEC system must meet both requirements.

2.3.1.2 Advantages and disadvantage of OSEC

Advantages:

- Onsite electrochlorination is $\sim 3-5 \times$ cheaper to run than buying hypochlorite (not considering labor).
- Salt stores easily and indefinitely (can be delivered annually).
- Salt is not hazardous to transport.
- Salt weighs $\sim 2 \times$ less than commercial bleach (for the same amount of chlorine), and is cheaper to transport.
- Onsite electrochlorination has a smaller carbon footprint than using commercial bleach (considering transportation costs).
- Solar powered OSEC has a smaller carbon footprint than using any commercial hypochlorite.

Disadvantages:

- Equipment costs are much higher than would be required for commercial hypochlorite dosing.
- More complex maintenance tasks are required than using commercial hypochlorite.
- The production process can go wrong (i.e. lower yields of chlorine result in poor disinfection) if poorly maintained.
- Equipment breakage, repairs and replacement could be costly.
- Security risk of theft e.g. solar panel equipment or rectifier unit etc. (items that are not necessarily required in commercial hypochlorite dosing).

2.3.2 Conclusions concerning OSEC at small rural sites

Onsite electrochlorination has potential benefit to small rural communities, especially regarding running costs. However, equipment costs and management capacity are determining factors. Therefore, existing systems can be summarized as follows:

- (i) Existing systems that are low maintenance (i.e. automated) are high in cost.
- (ii) Existing systems that are low in cost are high maintenance (i.e. manually operated).

Consequently, neither option is particularly appealing for small community management, especially when compared to dosing systems that use commercial hypochlorite (if and when possible). Existing OSEC systems, due to capital costs of equipment, appear to best suited for larger scale operations serving communities of 1,000 people or more. Therefore, a niche clearly exists for a cheaper small-scale OSEC/dosing system if one can be developed.

2.4 THE MEMBRANE ELECTROLYSER

The membrane electrolyser, is a small-scale device that can produce up to ~20 g of chlorine per day as either hypochlorous acid, or sodium hypochlorite (section 2.4.1 below). Its defining feature is a ceramic membrane (separating the anode and cathode), which improves the performance of the electrolyser over undivided hypochlorite generators (Linkov *et al.*, 2002). Based on its chlorine output capacity, the electrolyser could serve to chlorinate water volumes between 2-20 kL/day (depending on dose concentration) for ~100-200 people (section 2.5.2).

2.4.1 How it works

The main difference between the membrane electrolyser and standard hypochlorite generators is that it produces hypochlorous acid during electrolysis rather than hypochlorite (reactions 3-6 overleaf). This is achieved by a pH-limiting membrane made of aluminium-zirconium oxide that separates the brine-containing anode compartment from the water-containing cathode compartment (Fig. 2.5). Therefore, the electrolyser represents a hybrid between two forms of brine electrolysis. These are: (i) sodium hypochlorite generation in undivided electrolysis cells (i.e. hypochlorite generators) and (ii) chlorine gas generation in divided cells used in the chlor-alkali industry. These processes are discussed below in sections 2.4.2-2.4.4.

Anodic reaction:

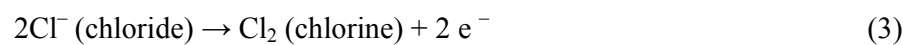

Cathodic reaction:

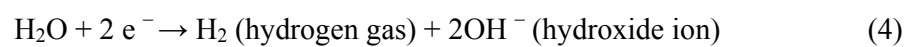

Hypochlorous acid formation:

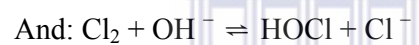
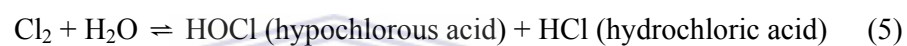

Hypochlorite formation:

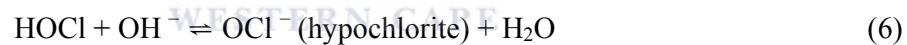

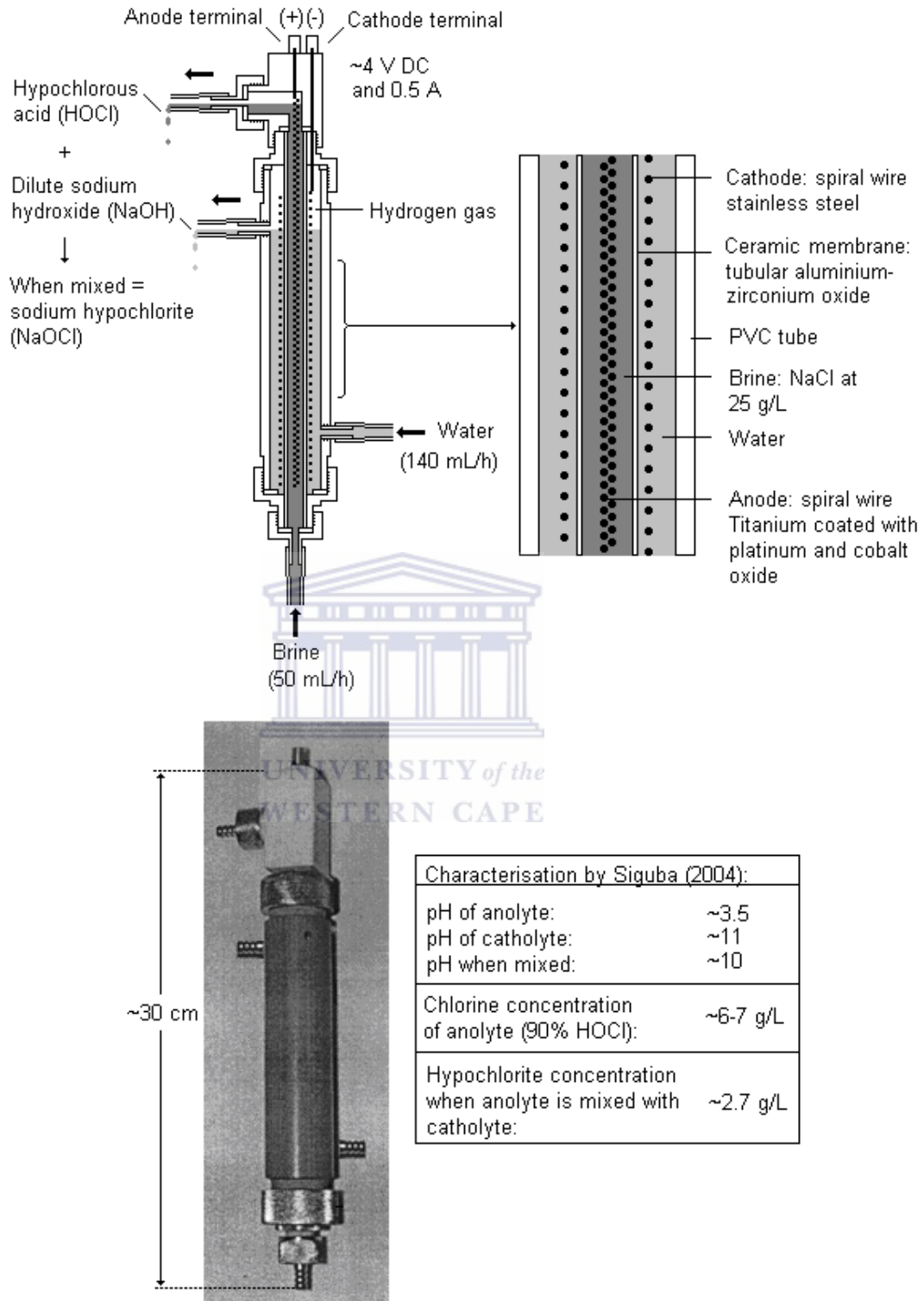

Fig. 2.5 The membrane electrolyser as developed by Linkov (2002). Longitudinal cross section schematic (above). Photograph (below)

2.4.2 Limiting factors of standard hypochlorite generators

The formation of hypochlorite (OCl^-) during electrolysis (reaction 6) in standard hypochlorite generators has a number of limiting effects on both electrolysis efficiency. The major limiting factor is the reduction of OCl^- back to chloride (Cl^-) at the cathode (Wallace and Tiernan OSEC®, 2002):

Reduction of OCl^- at the cathode:



Hypochlorite is also oxidised at the anode to produce chlorate and Cl^- , particularly at high temperatures and OCl^- concentrations (Krstajic *et al.*, 1991). The production of toxic chlorate is particularly unwanted and is restricted to 0.7 mg/L in drinking water (WHO GDWQ, 2005).

Oxidation of OCl^- at the anode:

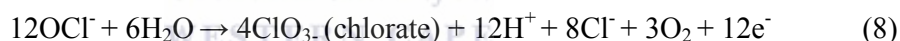

The net effect of these reactions during electrolysis results in:

- (i) Loss of current efficiency (i.e. energy is wasted).
- (ii) Loss of salt efficiency (i.e. salt is wasted).
- (iii) Toxic by-product formation (i.e. chlorate).

An ideal, 100%, conversion of NaCl to chlorine = 1.68 kg NaCl/kg Cl_2 . In the undivided cell this is considerably lower, at 3-4 kg NaCl/kg Cl_2 , and current efficiencies are 50-60% (i.e. 40-50% of the current does not yield chlorine). These losses can be accounted for by the above reactions (Pletcher, 1982 and Wallace and Tiernan OSEC®, 2002).

2.4.3 Chlor-alkali cells (Divided electrolysis cells)

By separating the anode and cathode reaction products by nafion (perfluoro-sulphonic acid resin: a cation selective membrane) the divided cell design is extremely efficient at producing chlorine gas (Fig. 2.6 B) yielding current and salt efficiencies close to 100% (Pletcher, 1982; White, 1999). The membrane prevents hydroxide ions formed at the cathode reacting with chlorine formed at the anode. This limits hydrolysis of chlorine gas into hypochlorous acid (HOCl) (reaction 5). This reaction occurs initially with water, but quickly reaches saturation point by the resultant decrease in pH as hydrochloric acid accumulates. The equilibrium at low pH forces any further chlorine produced at the anode to leave the solution as a gas, which is subsequently collected. The purpose of the membrane is twofold:

- (i) To prevent hydroxide ions formed at the cathode (reaction 4) raising the anolyte pH, which would allow more hypochlorous acid to form (reaction 5).
- (ii) To allow sodium ions to migrate to the cathode chamber in order to balance the loss of chloride at the anode.

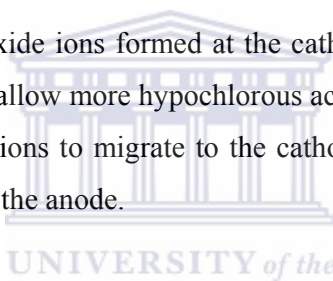

2.4.4 The pH limiting effect of the membrane electrolyser

The membrane electrolyser employs a ceramic (aluminium – zirconium oxide based) tubular membrane (Bashtan *et al.*, 1999) that limits the mixing of anodic and cathodic reaction products (Fig. 2.6 C). It differs from chlor-alkali cells in that it limits but does not completely exclude the migration of hydroxide ions. The membrane is not ion-selective as in the case of chlor-alkali cells, but rather, retards total ion movement, which allows a balance between chloride conversion to chlorine and its hydration via hydroxide ions to establish. The limitation allows enough hydroxide ions to hydrolyse chlorine to hypochlorous acid (reaction 5), but not enough to form hypochlorite (reaction 6), i.e. the membrane limits pH increase to below pH 5 (Fig. 2.7). Thus, the prevention of hypochlorite formation in the cell allows higher chlorine yields than undivided cells owing to preventing the limiting factors discussed in section 2.4.2. The membrane electrolyser has salt and current efficiencies of 2-2.5 kg NaCl/kg Cl₂ and 77% respectively (Linkov, 2002; Bashtan *et al.*, 1999).

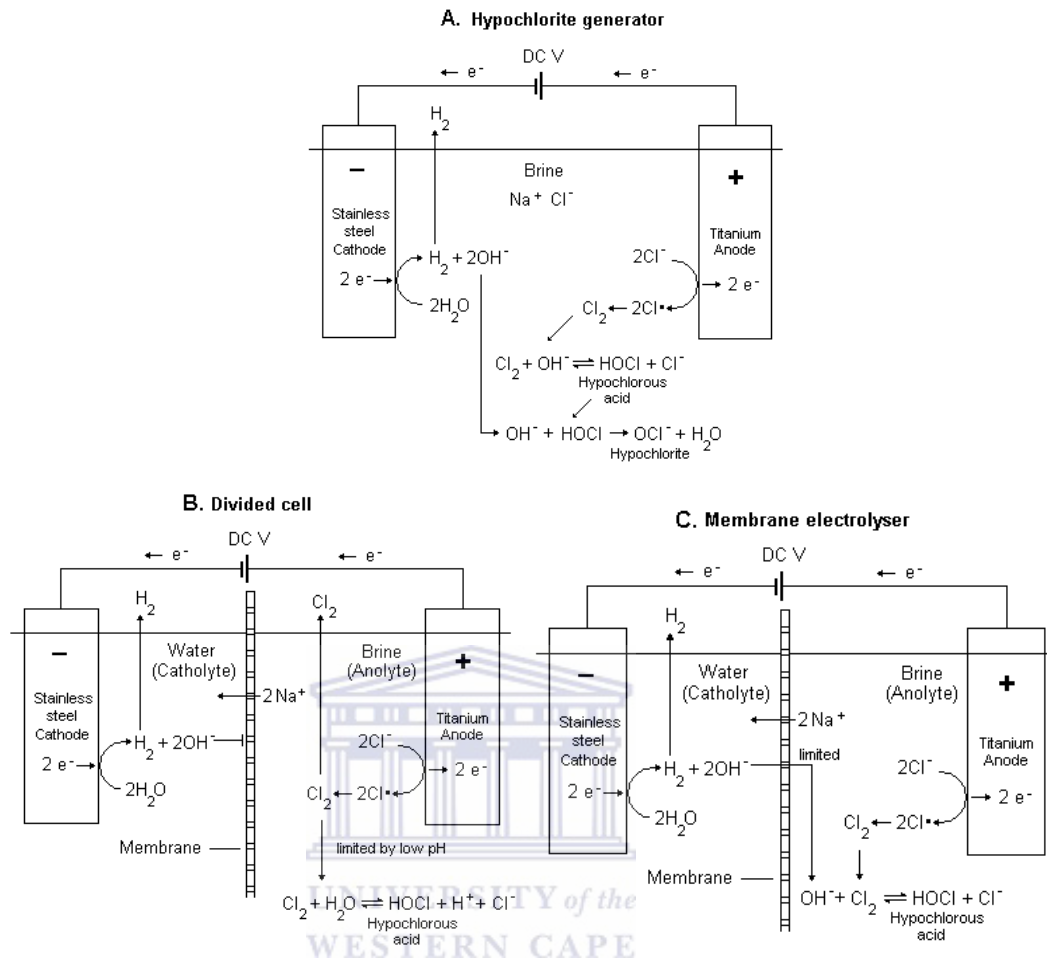

Fig. 2.6 Schematic of brine electrolysis cells. **A.** Hypochlorite production in a hypochlorite generator (undivided cell), **B.** Chlorine gas production in a divided cell, and **C.** Hypochlorous acid production in the membrane electrolyser.

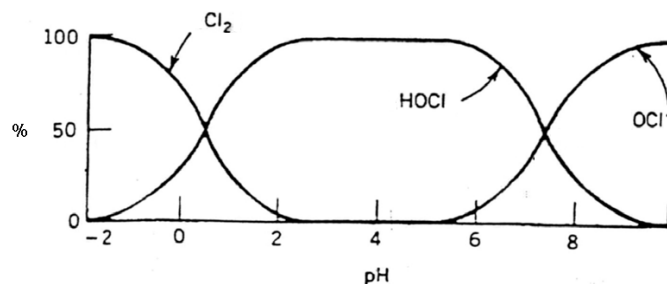

Fig. 2.7 Effect of pH on chlorine species in water

2.4.5 Comparison to MOGGOD (“Mixed Oxidant Gasses Generated On-site for Disinfection”)

Mixed Oxidant Gasses Generated On-site for Disinfection (MOGGOD) is a closely related technology of the chlor-alkali divided cell. In essence its function is the same as the chlor alkali cell (section 2.4.3), except that it is stated to produce a mixture of gasses (including chlorine and ozone) that are injected into water much the same as chlorine gas would be. The cell (OXI-0.1 and 0.5 models) is a small compact cylindrical unit that can be used safely on-site (Solsona and Pearson, 1995; Pearson, 2000). It comprises an anode compartment fed with brine and a cathode compartment fed with water separated by an ion selective membrane. The major difference between it and the membrane electrolyser is that it produces gasses and not hydrolysed chlorine (hypochlorous acid). The stated lifespan of the membrane and anode are stated at 6 and 30 months, respectively (this is no doubt variable according to the quality of the water where they operate).

On the basis of data presented by Solsona and Pearson (1995), the energy efficiency of MOGGOD might be slightly less than that of the membrane electrolyser i.e. 4.5 kWh/kg Cl₂-equivalent compared to 3.1 kWh/kg Cl₂ (Bashtan *et al.*, 1999), and its salt efficiency 1.7 kg NaCl/ kg Cl₂-equivalent is better than the membrane electrolyser at 2-2.5 (section 2.4.4). One drawback however, is that the cell produces concentrated sodium hydroxide which needs to be collected and disposed of. In 1995, when compared to UV radiation and hypochlorite generators its total cost (cell + equipment + operation) fell evenly beneath that of UV and above that of the hypochlorite generator.

2.4.6 Cost comparisons and efficiencies

The figures presented in Table 2.1 provide a rough guide to the running costs of the respective cells. They do not include the energy costs of peripheral operational equipment e.g. brine pumps etc. The results do show however, that all else being equal, the membrane electrolyser could be ~35% cheaper to run than hypochlorite generators.

TABLE 2.1 SALT AND ENERGY EFFICIENCIES COMPARED					
	Energy consumption		Salt consumption		Total
	kWh/kg Cl ₂	R/ kg Cl ₂	NaCl/ kg Cl ₂	R/kg Cl ₂	R/kg Cl ₂
Mem. electrolyser	~3	0.90	~2.5	5	5.90
MOGGOD	~4.5	1.35	~2	4	5.35
Hypo. generators	~4	1.20	~4	8	9.20
1 kWh = 30 c (ESKOM. Tariff restructuring plan 2008/9 (http://www.eskom.co.za/tariffs .)					
1 kg NaCl = R2 (variable according to bulk)					

The capital cost of the membrane electrolyser is, pending commercialisation and possible modifications, predicted to be ~R2 000-R2 500. The cost is primarily determined by the membrane material and DSAs (~R500 each per electrolyser in 2009).

2.4.7 Membranes in brine electrolysis

Any membrane-based technology must resign to the fact that the membrane has a definite life span. The pores of membranes are eventually blocked with time and their function (whether driven by pressure or electrical charge) will be reduced to a point where they need replacing.

Membrane blockage in brine electrolysis occurs primarily from salt precipitation of contaminant ions such as calcium and magnesium (Pletcher, 1982, and Kraft *et al.*, 1999), which form insoluble carbonates, particularly in the presence of heat and consequent loss of carbon dioxide from the solution (Pauling, 1970). Therefore, water hardness is a primary hindrance to membrane-based brine electrolysis, and more expensive operations (e.g. the chlor-alkali industry) often include water softeners to prevent the scaling phenomena. The pores of membranes can also block through aggregation and adsorption of colloidal particles, which maybe organic or inorganic in nature. In brine electrolysis, biofilm (i.e. from living microorganisms) blockage of the membrane is unlikely to occur due to the harsh conditions of chlorine and sodium hydroxide production.

The membrane of the membrane electrolyser is made from an alumina-zirconium oxide-based ceramic. It is thus hard and brittle in nature and requires careful handling on assembling and disassembling the electrolyser. The cost of the membrane, ~R500, must therefore be considered in terms of its life span, which in the intended application for this project was to be investigated. This must be weighed against the advantages of including it in the electrolyser (section 2.4.8, below) and thus its application must suit these advantages e.g. where rapid production of small quantities of chlorine would be required.

2.4.8 Advantages and disadvantages of the membrane electrolyser

Advantages:

- ~40% more salt efficient than hypochlorite generators.
- ~25% more energy efficient than hypochlorite generators.
- Produces no toxic by-products (chlorate).

Disadvantages:

- The cell design makes electrodes more difficult to access for cleaning purposes.
- Membrane may be prone to blockage resulting in reduced chlorine yield.
- Flow through design limits its range of applications.
- Only applicable to small-scale applications (unless a multi cell-type is developed).

2.4.9 Conclusions concerning the membrane electrolyser

The membrane electrolyser offers cost saving features suitable for small-scale hypochlorination systems, if its viability can be proven. Its efficiency advantages over hypochlorite generators indicate that it will cost less to run, i.e. reducing costs in salt purchase, electricity usage and solar panel size requirements. Challenges facing the electrolyser, concern the practicality of the membrane and how easily the electrolyser can be incorporated into a water disinfection system. Moreover, its application must be carefully chosen to best suit what it can do (i.e. make small volumes of hypochlorite rapidly and cheaply).

2.5 APPLICATIONS OF THE MEMBRANE ELECTROLYSER

The chlorination capacity of the electrolyser determines the volume range of water it can chlorinate and therefore the size range of the community it can serve. These are ranges rather than precise values due to variable factors such as the chlorine demand of the water and the average consumption volume of water per person within the community (section 2.5.1).

2.5.1 Chlorination capacity of the membrane electrolyser based on a dosing range

The electrolyser can produce between 11-22 g of chlorine per day (24 h) depending on the level of production efficiency required (i.e. current and salt efficiency) (Linkov, 2002). Table 2.2 shows the possible daily volumes of water that could be chlorinated for potable use with this quantity of chlorine considering different dosing concentrations.

Cl ₂ / day	Chlorine (mg/L) dose and water volumes (kL) / day (below)									
	1	2	3	4	5	6	7	8	9	10
11 g	1.1	5.5	3.7	2.8	2.2	1.8	1.6	1.4	1.2	1.1
22 g	22	11	7.3	5.5	4.4	3.7	3.2	2.8	2.4	2.2
15 g	15	7.5	5	3.8	3.0	2.5	2.1	1.9	1.7	1.5
Average										

The required chlorine dose of a water source depends on four main factors:

- (i) The chlorine demand of the water and system including storage tanks and reticulation (Momba and Brouckaert, 2005).
- (ii) Retention time required in storage tanks and reticulation systems (Hydes, 1999).
- (iii) The pH of the water i.e. this determines the oxidative strength of dissolved chlorine (White, 1999:217).
- (iv) Nitrogenous compounds in the water that render chlorine in various less reactive forms such as chloramines (White, 1999:223).

In a recent survey of 181 small water treatment plants (SWTPs) in South Africa (Momba *et al.*, 2008), of capacities between 0.3-120 ML of water per day, ~15% of those examined used sodium hypochlorite for chlorination, and a 7 mg/L chlorine dose concentration was reported as a typical value. In smaller systems, treating between 120-150 kL/day, a chlorine dosing range of 3-6 mg/L has been reported (Pearson, 2000). The effectiveness of these dose concentrations at their particular sites is discussed in their above mentioned references. These doses provide an indication of typical chlorine demands at working SWTP's in South Africa.

As can be read from Table 2.2 above, a dose range of 3-7 mg/L of chlorine correlates to a water chlorination volume range of ~2-5 kL/day for the daily chlorine output (mean 15 g) from one electrolyser. However, it is highly probable that smaller water disinfection systems, i.e. appropriate to the electrolyser, might require smaller doses, considering that retention time in very long pipelines will not be a factor. Therefore a dose range of 1-3 mg/L can also be considered, especially if the electrolyser is to be used specifically for chlorine residual boosting (section 2.5.3). This range corresponds to a larger water volume of 5-15 kL/day (Table 2.2).



2.5.2 Servable population size of the electrolyser

In 2002, the South African government stipulated a minimum of 25 L of potable water per person per day as a service provision goal (DWAF, 2002) while the *Strategic Framework for Water Services* recognized that where possible this should be increased to 50 L per person per day (DWAF, 2003).

- Therefore, if a 3-7 mg/L dose is required, 2-5 kL shared as either 25-50 L/ person gives a population range of 40-100 people.
- And, if a 1-3 mg/L dose is required, 5-15 kL shared as either 25-50 L/ person gives a population range of 100-600 people.

However, in practice water consumption is determined by many factors. Table 2.3 shows the effect of accessibility to the water source. Table 2.4 shows how the water volumes chlorinated by the electrolyser relate to these factors.

TABLE 2.3. THIRD WORLD DOMESTIC WATER CONSUMPTION AND ACCESSIBILITY (Sourced from Heber, 1985, compiled by IRC/WHO, 1981).		
Type of Water Supply	Average Consumption (L/person/day)	Range (L/person/day)
Communal water source:		
Distance > 1 km	7	5-10
Distance 0.5-1.0 km	12	10-15
Village well:		
Distance > 250 m	20	15-25
Public Standpipe:		
Distance > 250 m	30	20-50
Courtyard connection	40	20-80
House connection:		
One tap	50	30-60
Several taps	150	70-250
30% should be allowed for (unaccounted for) losses.		

TABLE 2.4. EFFECT OF WATER ACCESSIBILITY ON CONSUMPTION, AND SERVABLE POPULATION OF THE ELECTROLYSER (Adapted from Table 2.3 above)			
		Community size (No. of people)	
Type of Water Supply	Average Consumption (L/ person/day)	3-7 mg/L dose (2-5 kL)	1-3 mg/L Dose (5-15 kL)
Communal water source:			
Distance > 1 km	7	285-714	714-2142
Distance 0.5-1.0 km	12	166-416	416-1248
Village well:			
Distance > 250 m	20	100-250	250-750
Public Stand post:			
Distance > 250 m	30	66-166	166-498
Courtyard connection	40	50-125	125-375

House connection:			
One tap	50	40-100	100-300
Several taps	150	13-66	33-100
30% should be allowed for (unaccounted for) losses.			

2.5.3 Potential applications for the membrane electrolyser based on chlorination capacity

The chlorination capacity of the membrane electrolyser indicates it has two potential uses in drinking water chlorination:

- (i) Small-scale water disinfection (2-5 kL of water per day, with a 3-7 mg/L dose).
- (ii) Small-scale chlorine residual boosting (5-15 kL of water per day, with a 1-3 mg/L dose).

2.5.4 Small-scale water disinfection (potential sites and considerations)

The use of the electrolyser to fully disinfect water might require the high dosing concentration range of 3-7 mg/L. This equates to 2-5 kL of water per day to serve 40-100 people 50 L each. This number of people might be found at small rural farms, villages, schools, and clinics.

2.5.4.1 Target rural water sources

For drinking water purposes, chlorination must only be used on waters that have turbidity of < 5 NTU (SANS 241, 2005). Higher NTU values have high and uncontrollable chlorine demands (Obi, *et al.*, 2008) and increase the risk of toxic trihalomethanes (THMs) forming in the water (Carlsson, 2003). Therefore, unless turbidity is < 5 NTU chlorination is not a safe option and pre-treatment clarification methods will be required. Table 2.5 shows the typical type of pre-treatment required at surface waters of different turbidities. The use of the membrane electrolyser at surface water therefore requires suitable small-scale pre-treatment options. However, the electrolyser does have more immediate site options where turbidity is not an issue. Examples of these are:

- Ground water sources (e.g. boreholes, wells and springs protected by a spring box).

- Roof-top rain harvesting tanks.
- Sites where turbidity is moderate and simple sand filtration is sufficient (Table 2.5).
- Sites where some form of pretreatment system already exists.

TABLE 2.5. GUIDELINES FOR THE SELECTION OF A WATER TREATMENT SYSTEM FOR SURFACE WATERS IN RURAL AREAS (from Swartz, 2000)				
Average raw water quality	Water demand (kL/d)	Treatment suggested	Skills needed	Capital + Operating costs
Turbidity < 5 NTU Faecal coliform 0 CFU/100 mL Bilharzia not endemic	up to 2000	No treatment (filtration and disinfection recommended for surface water treatment)	nil (low – med)	nil (low – med)
Turbidity < 10 NTU Faecal coliform 0 CFU/100 mL Bilharzia endemic	up to 5000	1. Rapid sand filtration 2. Slow sand filtration	med low	med + low med + low
Turbidity 20-50 NTU Faecal coliform 1 - 500 CFU per 100 mL	up to 5000	1. Rapid sand filtration + disinfection (Cl ₂) 2. Slow sand filtration + disinfection (Cl ₂) if possible	med low	med + med med + low
Turbidity < 50-150 NTU Faecal coliform 1- 500 CFU per 100 mL	up to 5000	1. Sedimentation + rapid sand filtration + disinfection (Cl ₂) 2. Sedimentation + slow sand filtration + disinfection (Cl ₂) if possible	med med	high + med high + low
Turbidity < 50 - 150 NTU Faecal coliform > 500 CFU per 100 mL	up to 5000	Pre-treatment (coag, floc & sedimentation) + filtration (rapid or slow sand + disinfection)	high	v. high + high
Turbidity > 150 NTU	Detailed investigation and possible pilot study work may be required			

2.5.5 Small-scale chlorine residual boosting

A second application option for the membrane electrolyser is to boost chlorine residual in water supplied from SWTPs. Maintaining the correct chlorine residual (0.1-0.5 mg/l)

in water after it has been chlorinated, piped, stored, piped again and reaches the point of use (POU), (e.g. a tap), is an important but often difficult task to achieve. Loss of residual at taps appears to be a fairly common problem for SWTPs (Momba *et al.*, 2008; Pearson, 2000). Here, the losses occur for a variety of reasons including, under dosing of chlorine, interruptions in pipe flow, prolonged stagnation in storage tanks, increases in turbidity and other changes in the pretreated water quality.

Chlorine boosting near the POU with doses of 1-3 mg/l (depending on the point of application) provides the chlorine residual required in water. In terms of the daily chlorine output (15 g) from the membrane electrolyser, a corresponding maximum of 15 kL of water could be residual boosted at 1 mg/l or 5 kL at 3 mg/l (Table 2.4). These volumes might represent one small reservoir (or many smaller tanks) supplying up to 300 people (depending on the chlorine demand) assuming a consumption of 50 L for each person per day. The numbers can be simply divided by the appropriate factor for greater levels of personal consumption.

2.6 IMPLEMENTING THE MEMBRANE ELECTROLYSER

The question of how to implement the electrolyser requires consideration of the cost of equipment required to run it and the number of people that it can serve. The electrolyser due its design and small size makes this a difficult task (see below)

- (i) The constant flow-through design of the electrolyser is not suited to manual operation and thus requires some level of automation
- (ii) The small size and capacity of the electrolyser does not justify the costs of standard electrical automation control equipment, particularly for poor rural areas

To achieve affordable automation electrical components must be small, low power, and kept to a minimum, and where possible alternative control mechanisms should to be used.

2.6.1 Basic components a complete disinfection system

The basic components of equipment required to form a disinfection system incorporating the membrane electrolyser are:

- Water delivery infrastructure (including abstraction, possible pre-treatment, storage and distribution).
- Electrical power source (mains or solar power).
- Control of hypochlorite production (see below).
- Control of hypochlorite dosing (see below).

Hypochlorite production and hypochlorite dosing form the two main control points for consideration. Their respective components are:

2.6.1.1 Control of hypochlorite production:

- Control of power to the electrolyser
- Control of brine flow-through supply to the anode chamber
- Control of water flow-through supply to the cathode chamber

2.6.1.2 Control of hypochlorite dosing:

- Control of dosing rate (see 2.6.3)

2.6.2 Minimum electrical power requirements and solar panels

The use of solar panels to power the electrolyser may be a necessity in some rural areas. While high in capital cost, solar panels can provide a sustainable source of power for over 20 years (a commonly stated estimate for their predicted life-span). Based on previous reports (Linkov, 2002; Bashtan *et al.*, 1999) it can be calculated that the electrolyser if run continuously over 24 h would require 62 Wh/day: (i.e. at 1.3 kWh/kg Cl₂ and 20 g/day = $20 / 1000 \times 3.1 = 62$ Wh/day). Therefore, for a 6-hour strong daylight period, a 30 W PV solar panel would provide $30 \times 6 = 180$ Wh/day or nearly double the draw from the electrolyser. The cost of such a panel (~R1 200) including 12

V battery and regulator (controller) comes to ~R2 500 (2009 prices, source: Sunpower® <http://sunpower.co.za/>). Each additional electrical control component added to the system increases the cost dramatically in terms of solar panel requirements. For example inclusion of one of the smallest available types of dosing pumps the “Min-E-Wash” model (Manufacturer: HydroNovaEurope®) requires 30 W (section 2.6.) and if run for more than two hours per day requires another 30 W solar panel in addition to its own capital cost of over R1 000. Therefore, this illustrates the need to keep electrical components to a minimum.

2.6.3 Sodium hypochlorite dosing methods: costs and considerations

Dosing of sodium hypochlorite to water can be carried out in a variety of ways ranging from manual to highly automated. Dosing equipment can therefore be another major component of capital cost in hypochlorination treatment. Above all, dosing must be consistent and reliable, ensuring that chlorine is evenly distributed in the water and given enough time to disinfect the water (Carlsson, 2003). Below are some of the options:

2.6.3.1 Manual dosing

This is usually carried out as a batch dosing procedure at various levels of scale. It is by far the simplest form of dosing, where a volume of sodium hypochlorite is simply hand-poured into a corresponding volume of water whether it is a bucket or a 2.5 kL tank. Thorough mixing and sufficient chlorine contact time (at least 30 minutes) are required for reliable disinfection (White, 1999:333). The method is labour intensive, but certainly has its place in emergency treatment of drinking water (<http://www.cdc.gov/safewater/publications>).

2.6.3.2 Non-electrical dosing mechanisms

Two categories of non-electrical mechanisms exist for dosing sodium hypochlorite (or dissolved calcium hypochlorite): (i) gravity powered chlorinators and (ii) water-powered chlorinators. Both have their pros and cons, and are an affordable option when and where they can be used, since they generally do not require expensive parts or a

supply of electricity. Such systems can cost less than a few hundred Rand to purchase or build, and are long lived, and in general do not require complex parts so they can be easily repaired on-site.

Gravity driven chlorinators – In the main, these systems provide an adjustable drip feed of sodium hypochlorite into flowing water. They require an open head of water at atmospheric pressure and cannot be used on pressurised pipe lines. They do not self-adjust to variable flow rates of water and must therefore be adjusted manually. However they are an affordable option that can be constructed and maintained cheaply without the need for highly specialised equipment.

Examples include:

- (i) the Mariotte jar,
- (ii) Inverted bottle with floating valve,
- (iii) Constant head tank,
- (iv) Floating draw-off pipe, and
- (v) the Vandos feeder.

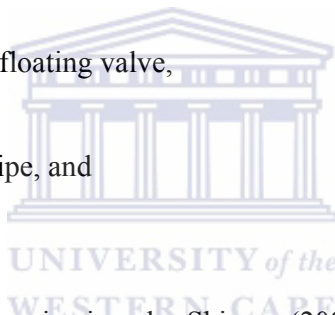

A review of these systems is given by Skinner (2001). The Mariotte jar (Fig. 2.8), also known as a ‘constant-head aspirator’, is perhaps the one exception among the above that can be arranged to have a degree of self-regulation. It is a sealed, rigid bottle that provides a constant drip of sodium hypochlorite via the drip’s replacement by a bubble of air from a submerged pipe in the bottle. It can be arranged in such a way that the drip stops when the water flow stops (i.e. when the water demand stops). This is achieved by positioning the outside end of the air pipe at a fixed level in a water flow-through tank, that when full, rises to a level that submerges the pipe and cuts off the air to the Mariotte jar (WRC UK, 1984).

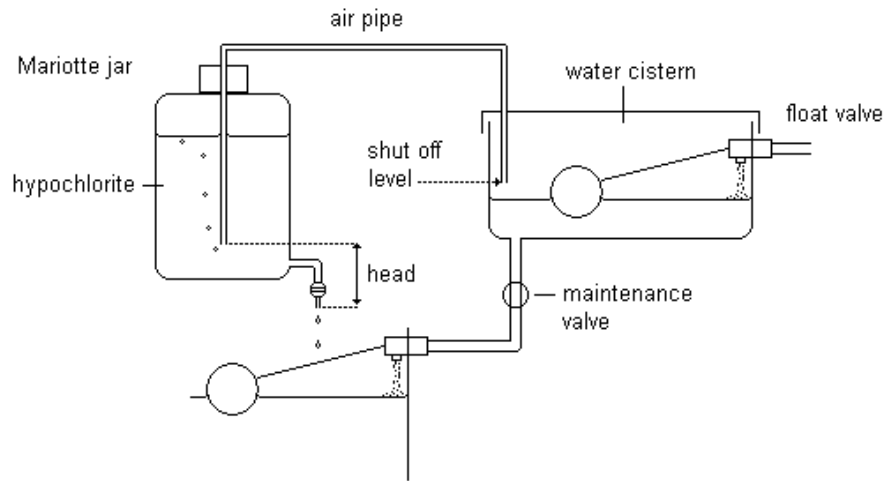

Fig. 2.8 Drip dosing of hypochlorite: Mariotte jar with shut off mechanism.

Water-powered chlorinators – Here, moving water powers a mechanical device, or produces a reduced pressure, which is used to dose the chlorine solution into the water (Skinner, 2001). Unlike the above mentioned drip based systems, most water powered systems self adjust their dose to the flow rate of water being dosed.

The mechanical category includes:

- (i) Wheel feeder dosers (hollow-spoke wheel feeder Fig. 2.9, overleaf),
- (ii) Float-powered chemical doser and
- (iv) Hydraulic motor/piston driven dosers (Skinner, 2001).

The mechanical systems, with the exception of (iv) only work at atmospheric pressure.

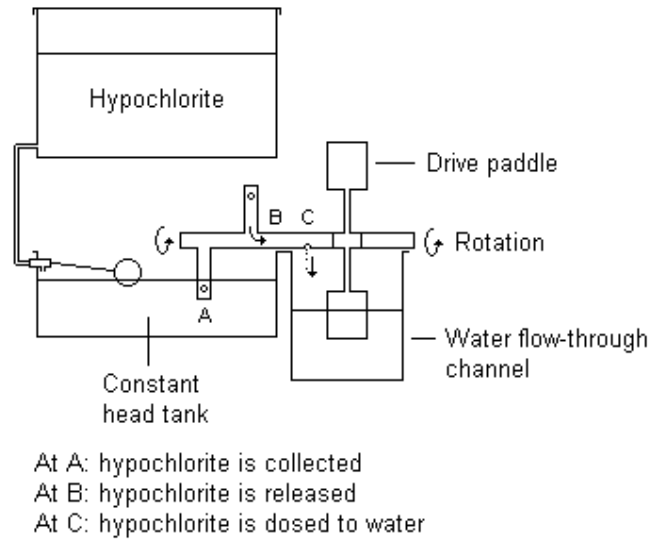

Fig. 2.9 Water-driven hypochlorite dosing: Hollow-spoke wheel feeder.
 (adapted from Skinner, 2001)

The pressure driven category includes:

- (i) Venturi-powered dosers (Fig. 2.10),
- (ii) Direct suction dosers, and
- (iii) Displacement-bag doser.

The Venturi (or eductor) requires a minimum pipe flow rate to work reliably, and it and (ii) require a constant head tank feeder (provided by a cistern with a float valve). The Venturi and Displacement-bag doser both require pipe pressure to operate.

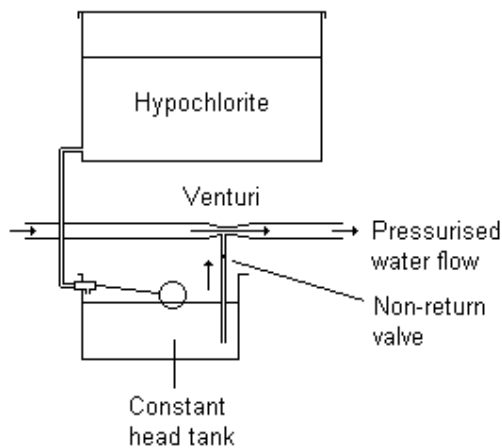

Fig. 2.10 Pressure-driven hypochlorite dosing: Venturi doser (adapted from Skinner, 2001).

2.6.3.3 Hypochlorite dosing Pumps

Hypochlorite dosing pumps provide a versatile but generally expensive option. They can be either electrical or non-electrical. Non-electrical pumps (e.g. hydraulic motor/piston driven dosers made by Dosatron®) require a minimum pressure to operate and are therefore only suitable for systems with a regular high flow rate. Electrical pumps are available in many designs and sizes and can cater for a wide range of dosing rates and pipe pressures. However, for small systems in rural areas the cost of the pump and the corresponding solar panel requirements might exceed the cost of the hypochlorite generator and solar panels required for OSEC. Furthermore, in a small OSEC system, the energy required to run the pump on a continuous basis might exceed that of the energy required to power OSEC.

The use of electrical pumps must be carefully considered in terms of the nature of the application. Where possible the pump should be positioned in the system so that it operates for minimum periods of time rather than continuously. Examples include: (i) pumping the produced hypochlorite as a batch to fill a small tank that feeds a Venturi eductor (Fig. 2.6) and (ii) pumping a batch volume of hypochlorite into a batch volume of water. The system could be regulated by a small level switch located in the tank that turns the pump on and off accordingly. Used correctly, pumps can have long life spans

but should be restricted to use in situations where they can be repaired or replaced with minimum interruption and delay to the site's operation. Table 2.6 gives details of a small electric peristaltic dosing pump:

TABLE 2.6. A TYPICAL SMALL PERISTALTIC DOSING PUMP

(E.g. "Min-E-Wash". Manufacturer: HydroNovaEurope®, distributor in S.A.: fildos, Cape Town.)

Capacity	Pump rate = 110 mL / min; Max vol. in 24 h = 158.4 L/day
Electrical	Voltage = AC or DC; Power = 30 W
Maintenance	Replacement of tubing
Price	Between R1 000-R2 000

2.6.4 Maintenance and safety

The running of OSEC, whether using manually operated hypochlorite generators or automated, requires diligent maintenance and safety precautions. Listed below are some of the routine procedures that must be implemented:

2.6.4.1 Maintenance:

- Brine replenishment (either via salt addition or brine preparation): This requires a regular operator.
- Cleaning of electrodes: In areas that have hard alkaline water, lime-scale deposits quickly accumulate on the cathode electrode of the hypochlorite generator. In such cases, routine washing of the electrode either in vinegar or dilute hydrochloric acid must be carried out. The accumulation causes current loss between the electrodes, resulting lower concentration yields of chlorine. This is why some automated systems have water softeners included.
- Overall system checks: Operator awareness to appropriate current readings on display panels is advisable. Low current readings are a definite indicator of reduced production efficiency. Checking for pipe tears and leakage at peristaltic pumps (if present).

2.6.4.2 Safety:

- Ventilation of hydrogen emissions from the cathodic reaction: a well ventilated room sufficiently removes these, but for large plants extraction and capturing devices may be required. (No smoking signs should be present in the housing).
- Rubber gloves and goggles should be available if needed, but routine operations should not necessarily require them.
- Housing kept below 40°C to prevent excessive chlorine emissions and hypochlorite decomposition (toxic by-product formation), (Gordon *et al.*, 1997).
- An effective emergency response protocol for malfunction or breakdown of hypochlorite production and dosing equipment.



CHAPTER 3

AIMS AND OBJECTIVES

The thesis had two main objectives: (1) to develop a water disinfection system in which the electrolyser can operate automatically, and (2) to establish and test the disinfection system at a typical water source used by a rural community and determine its viability.

The specific aims of the project were as follows:

- (i) To establish the most suitable electrolyser design, construction materials and operational parameters to provide a device that is reliable, affordable, energy efficient and durable.
- (ii) To develop a disinfection system that incorporates the electrolyser, and accurately doses water in a manner that is automatic, low maintenance, solar powered, low cost and sustainable.
- (iii) To establish and operate the disinfection system at a rural water site following the necessary laboratory testing, authorization from the relevant water authority, and the rural community's consent.
- (iv) To determine the viability of the system and its acceptance among the rural community with regard to its operational performance and intended maintenance by the community.

CHAPTER 4

RESEARCH METHODS

4.1 OPERATION OF THE ELECTROLYSER

4.1.1 Electrolyte supply

4.1.1.1 Electrolyte flow rates and brine concentration

Plug flow rates (established by Siguba, 2004) and brine supply concentration was as follows:

- Brine: 50 ml/h
- Water: 140 ml/h
- Brine concentration: NaCl 25 g/L in tap water

4.1.1.2 Electrolyte supply methods

Three methods of electrolyte supply were investigated (Fig. 4.1: overleaf), each method providing a fixed head of electrolyte to maintain a constant flow supply to the electrolyser.

- Method ‘A’ was used by Siguba (2004) in the laboratory, and uses a peristaltic pump to provide constant circulation to two head tanks.
- Method ‘B’ was investigated in the present thesis as an intended low cost system and uses the Marriote jar principle to maintain a constant flow. The method required airtight jars that were rigid in construction.
- Method ‘C’ was the second method explored in this thesis and employs two float valves to maintain a fixed head of electrolyte.

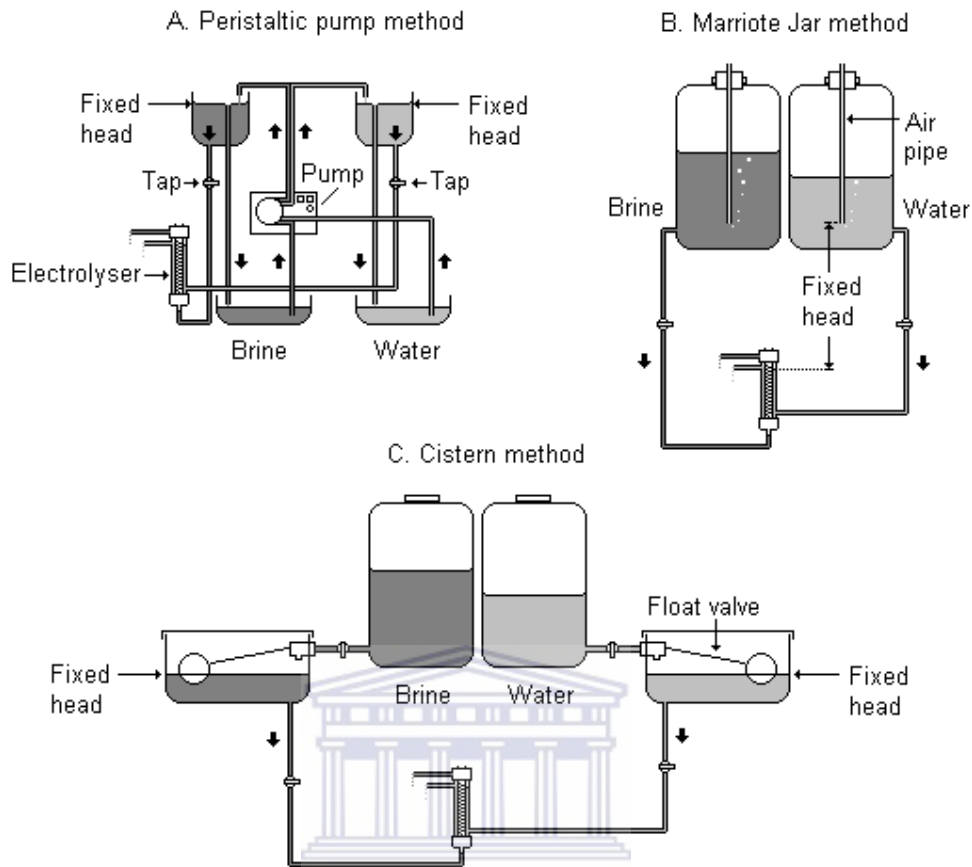

Fig. 4.1 Plug flow electrolyte supply methods

4.1.2 Power supply and current readings in the laboratory

The DC power supply for the electrolyser experiments in the laboratory was a TTi (Thurlby Thandar instruments) model: EX18R power supply (Max. 18 V and 10 A).

4.2 ANALYTICAL METHODS

4.2.1 Chlorine (FAC) measurement

Measurement of FAC (free available chlorine) in both laboratory tests and in the field was carried out using a portable “Free and total chlorine and pH meter” MI411 (Martini® instruments) according to the manufactures instructions.

4.2.2 pH measurement

pH was measured in the field with the above chlorine “Free and total chlorine and pH meter”.

4.2.3 Turbidity measurement

Turbidity was measured in FNU using a portable “Turbidity meter” MI415 (Martini® instruments) according to the manufactures instructions.

4.3 CALCULATION OF FIGURES OF MERIT

The efficiency of chlorine production was evaluated in terms of (i) electrical energy expended to produce chlorine and (ii) the amount of salt used to produce chlorine. These terms were calculated by recording the voltage, current, electrolysis time and salt consumption used to produce a specific quantity of chlorine (see below).

4.3.1 Electrical energy

The amount of electrical energy expended to produce a given amount of chlorine reveals the electrical efficiency of the cell and can be expressed in the following two ways:

4.3.1.1 Power efficiency (kWh / kg Cl₂)

The simplest and most practical expression of energy expenditure is power efficiency in kWh / kg Cl₂. This can be calculated from: voltage (V), current (I), time (h) and chlorine yield (see below):

E.g. If a cell ran at 4 V and 0.5 A for 24 h produced 10 g Cl₂ (measured analytically) the power efficiency is calculated as follows:

Electrical power (P) = IV = 2 W

And: Wh / 10 g Cl₂ = 2 W × 24 = 48 Wh

Therefore:

$$\text{Wh} / 1000 \text{ g Cl}_2 = 48 \times 1000/10 = 4,800 \text{ Wh or } \underline{4.8 \text{ kWh/ kg Cl}_2}.$$

4.3.1.2 Current efficiency (%)

Current efficiency is the percentage of current passed in the cell that yielded chlorine, and requires the measurement of current, time and chlorine yield (see below):

E.g. If a cell ran at 0.5 A for 24 h produced 10 g Cl₂ (measured analytically) the current efficiency is calculated as follows:

$$Q = mnF$$

Q = electrical charge in Coulombs (C)

m = product formed in Moles

n = number of electrons required to convert reactant to product

F = Faraday's constant (96484 C/ mole of electrons)

Therefore in $2\text{Cl}^- \rightarrow \text{Cl}_2 + 2e^-$, one molecule of chlorine requires 2 electrons. And the electrical charge required to generate one mole of molecular chlorine (71 g) is:

$$Q \text{ for 1 mole of molecular chlorine} = 1 \times 2 \times 96484 = 192968 \text{ C}$$

$$\text{Therefore } Q \text{ for 10 g chlorine } (10/71 = 0.1408 \text{ moles}) = 192968 \times 0.1408 = 27178.59 \text{ C}$$

$$1 \text{ Ampere} = 1 \text{ C / sec}$$

$$Q = It$$

$$\text{Therefore } Q \text{ for 0.5 A for 24 h} = 0.5 \times 3600 \times 24 = 43200 \text{ C}$$

$$\text{Current efficiency} = \frac{\text{charge consumed for chlorine production}}{\text{Total charge passed}} \times 100$$

$$= (27178.59 / 43200) \times 100 = \underline{62.91\%}$$

4.3.2 Salt consumption

The efficiency of chloride conversion to chlorine can be expressed in terms of NaCl kg used / Cl₂ kg produced or as a percentage in material yield. These calculations require knowing the amount of salt used and the amount of chlorine produced:

4.3.2.1 Salt efficiency (mass ratio: NaCl kg / kg Cl₂)

Two moles of NaCl (2 × 58.5 g) are required to produce one mole of molecular Cl₂ (71 g), i.e. $2\text{NaCl} + 2\text{H}_2\text{O} \rightarrow 2\text{NaOH} + \text{H}_2 + \text{Cl}_2$

Therefore: 2 × 58.5 g = 119 g NaCl

And: 119/71 = 1.68 kg NaCl / kg chlorine

E.g. If a 1 L cell of brine contained 25 g NaCl and produced 10 g Cl₂ the salt efficiency in mass ratio is as follows:

Mass ratio = 25/10 = 2.5 kg NaCl / kg Cl₂

4.3.2.2 Material yield (% salt efficiency)

Since two moles NaCl gives one mole Cl₂, a 2:1 mole ratio of NaCl to Cl₂ = 100% efficiency or maximum possible yield or 1.68 kg NaCl: 1 kg Cl₂ = 100% salt efficiency.

% salt efficiency = 100 × 2 × moles of Cl₂ / moles of NaCl

E.g. If a 1 L cell contained 25 g NaCl and produced 10 g Cl₂ the percentage material yield is as follows:

25 g NaCl = 25/58.5 = 0.427 moles NaCl

10 g Cl₂ = 10/71 = 0.141 moles Cl₂

(0.141/0.427) × 2 × 100 = 66.04%

4.3.3 Calculating Figures of merit in a batch reactor

In a batch reactor the calculations concerning electrical efficiency require measurement of current over the duration of the electrolysis period. This produces a plot curve that can be used to calculate both power and current efficiency by integration.

- In the case of current efficiency, integration of the graph of current (I) and time (T), i.e. IT , gives the charge in coulombs (C) passed over the period of electrolysis. The total charge value is then applied to the formula in section 4.3.1.2 above.
- In the case of power efficiency, integration of the graph of power and time, i.e. $\text{power} \times \text{time}$, gives the electrical energy in Watt hours (W.h) consumed over the period of electrolysis. The Watt hour value is then applied to the formula in section 4.3.1.1 above

Integration of the above graphs was carried out using Microsoft Origin® software.

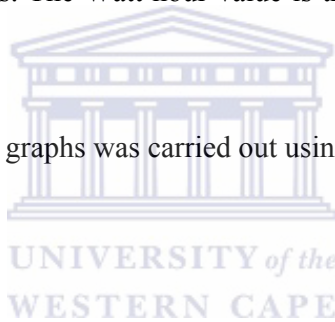

CHAPTER 5

OPERATION AND TESTING OF THE MEMBRANE ELECTROLYSER

This chapter presents the groundwork for developing electrolyser's operating system. The chapter includes: modifications to electrolyser design (section 5.1); developing an electrolyte supply system (section 5.2); evaluation of membrane function (section 5.3) and effect of turbidity on membrane function (section 5.4).

5.1 MODIFICATIONS TO ELECTROLYSER DESIGN

Initial testing of the electrolyser under the conditions previously used by Siguba (2004), (see Chapter 4, section 4.1.1) in the laboratory revealed that various modifications were required to improve its function (see below).

5.1.1 Redesign of top and base caps

5.1.1.1 Construction Material

Long-term exposure of the nylon top cap to the highly oxidative conditions of chlorine production had resulted in corrosion blockage of the cap's lumen and interruption of electrolyte flow. Therefore, the cap was reconstructed from PVC, which is more resistant to chlorine attack (White, 1999: 146-147), see Fig. 5.1. The PVC caps suffered negligible corrosion through the subsequent two-year duration of the project.

5.1.1.2 Wider outlet nozzles

The narrow outlets nozzles for the anolyte and catholyte chambers gave rise to airlocks resulting in erratic outlet drip rates. Therefore, the nozzles (Fig. 5.1) were made wider (from 3 mm to 6 mm internal diameter) to allow gases evolved during electrolysis to escape without interrupting the flow of electrolytes. The new design gave considerably less airlocks.

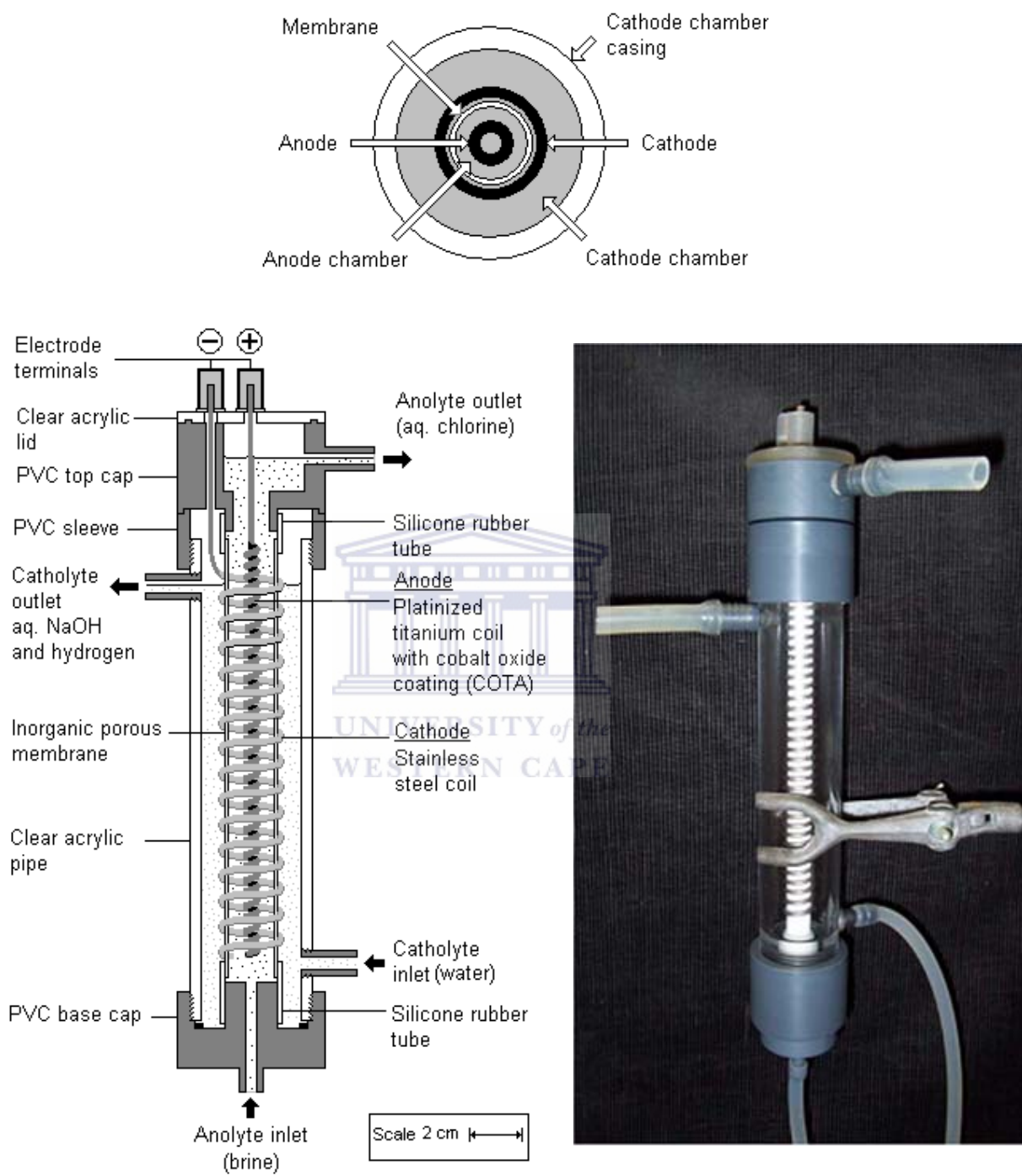

Fig. 5.1 The membrane electrolyser. Top: schematic of horizontal cross section. Left: schematic of longitudinal cross section. Right: photograph showing pipe connections.

5.1.1.3 Safer membrane attachment

In the previous design, the ceramic membrane was sandwiched at either end by two silicone ring washers on the top and base caps, which served to seal off the anolyte and catholyte chambers (Chapter 2 Section 2.4.1, Fig. 2.5). This required sufficient pressure when tightening the caps, and would often result in membrane breakage upon assembling and disassembling the electrolyser. Therefore, the caps were redesigned to attach the membrane via silicone rubber tubes (Fig. 5.1). This method of assembly required the inclusion of a threaded sleeve under top cap, which when rotated upwards served to firmly secure the top cap assembly.

5.2 DEVELOPING AN ELECTROLYTE SUPPLY SYSTEM

5.2.1 Problems concerning electrolyte supply

Two problems were immediately apparent with the previously established “plug flow” mode of operation:

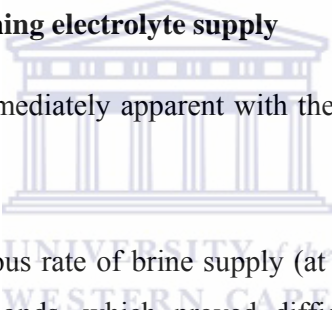
- 
- (i) The slow continuous rate of brine supply (at 50 mL/h) formed a drip rate of < 1 drop every 2 seconds, which proved difficult to maintain without continual correction of the inline tap on the brine supply pipe.
 - (ii) When the electrolyser was not in operation, the catholyte and anolyte mix by diffusion across the membrane. This results in initial low yields of chlorine (data not shown) and inconsistency of the electrolyser’s product.

Both problems presented major obstacles to operating the electrolyser in a manner that was consistent and low maintenance. Various attempts were made to establish a constant drip rate and even a medical drip was investigated. However, in all cases the slow speed of the drip was prone to stoppage or change and generally proved impossible to maintain. Therefore, a radical change in electrolyser’s mode of operation needed to be considered (see below).

5.2.2 A batch supply system

In considering the above problems, a new operating system was devised that could also form the basis for hypochlorite dosing. Here, the electrolyser changes from a plug flow reactor to a batch reactor, i.e. through supplying the electrolyser with a batch of brine in place of a drip. The problem of membrane diffusion could be solved by flushing the electrolyser with water after a set electrolysis period, thus leaving only water in the chambers during periods of no operation. Furthermore, the flushing of the electrolyser would provide the method of dosing a batch of water with a batch of hypochlorite. The sequence for this system is given below:

- *Stage 1:* the electrolyser contains water in both the anolyte and catholyte chambers
- *Stage 2:* the electrolyser is supplied with a batch of brine that displaces the water in the anolyte chamber
- *Stage 3:* electrolysis starts due to the presence of brine in the anolyte chamber and continues for a fixed period of residence time
- *Stage 4:* the electrolyser is flushed with water and the hypochlorite is carried to a dosing tank containing a fixed volume of water.

WESTERN CAPE

The above suggested batch supply system did however create two new requirements: (i) a means of controlling batch supply and (ii) determination of how the electrolyser would function as a batch reactor. The latter requirement was explored first to establish the viability of batch supply (see below).

5.2.3 Operation of the electrolyser as a batch reactor

Under the previous plug flow conditions, the concentration of reactants and products remained constant in both the catholyte and anolyte. Here, flow rate determined the figures of merit for chlorine production. In contrast, under batch reactor conditions, electrolysis starts with water as the catholyte and brine as the anolyte. Here, as electrolysis commences, the concentration of electrolysis products accumulates and a period of optimal electrolysis time will be reached. This period, or batch residence

period, needed to be determined experimentally by measuring chlorine production over a range of batch residence times (see below).

5.2.3.1 Evaluation of a range of batch residence times

Method:

Chlorine yield and current were evaluated over 5, 10, 15, 20 and 25 min batch residence times using the following protocol. The electrolyser was set up with a 4 V supply (see Chapter 4, section 4.1.2). Both chambers of the electrolyser were first filled with tap water. To start electrolysis, a 15 ml batch of brine (NaCl at 25 g/L) was poured into the anolyte chamber. This displaced the resident water in the anolyte chamber and initiated electrolysis. After the chosen period of residence time was complete, the anolyte and catholyte chamber were flushed by 200 ml of water into the same beaker for chlorine measurement. The resultant 400 ml was diluted with water to 1 L as a stock solution for chlorine measurement. FAC (free available chlorine) was measured using the Martini instrument test kit (Chapter 4, section 4.2.1), using appropriate dilution to measure chlorine in the range of 1-10 mg/L. For each batch residence period, an average from three recorded batches was used for evaluation. The Current readings were recorded at 5 min intervals during the batch residence periods. Figures of merit for electrolysis were calculated (Chapter 4, section 4.3.3) from the data.

Results and discussion:

Fig 5.2 (overleaf) shows the plotted chlorine yields from the five residence times. The points produced a curve with the highest yield averaging at ~5.6 g/L, at a 10 min residence time. The curve indicates that chlorine concentration is still increasing at 5 min and at 25 min it is decreasing. The effect of residence time on current in the electrolyser followed a similar pattern, where a maximum current of 0.58 A was reached after a 5 min residence period and gradually declined to 0.23 A after 25 min.

The results suggest that a maximum chlorine concentration was most likely to exist between 5 and 15 min of batch residence in the electrolyser. The lower chlorine

concentration produced after 15 min residence time shows that chlorine was lost to some process occurring in the electrolyser between these times. The loss appears analogous to the effect of using the membrane electrolyser with slow catholyte flows (Bashtan *et al.*, 1999); here sufficient hydroxide ions pass through the membrane to convert hypochlorous acid in the anolyte chamber to hypochlorite, which undergoes numerous reactions at the electrodes resulting in loss of chlorine (Chapter 2, section 2.4.2).

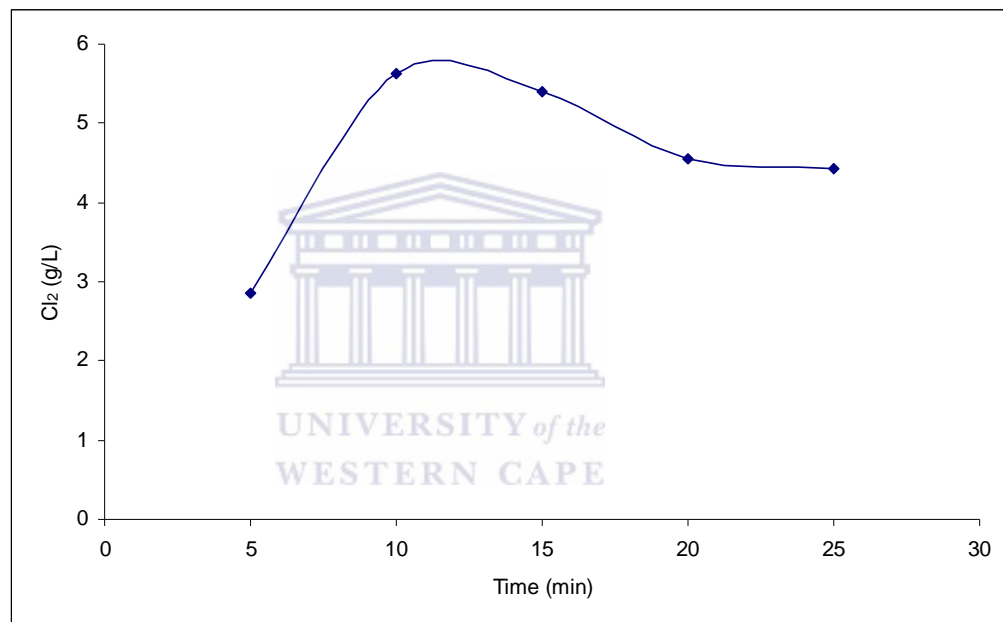

	Chlorine concentration (g/L)				
	5 min	10 min	15 min	20 min	25 min
Batch 1	2.93	5.7	5.58	4.61	4.49
Batch 2	2.82	5.56	5.26	4.5	4.39
Batch 3	2.83	5.61	5.39	4.58	4.4
Ave.	2.86	5.62	5.41	4.56	4.43

Fig. 5.2 Chlorine production vs. batch residence time

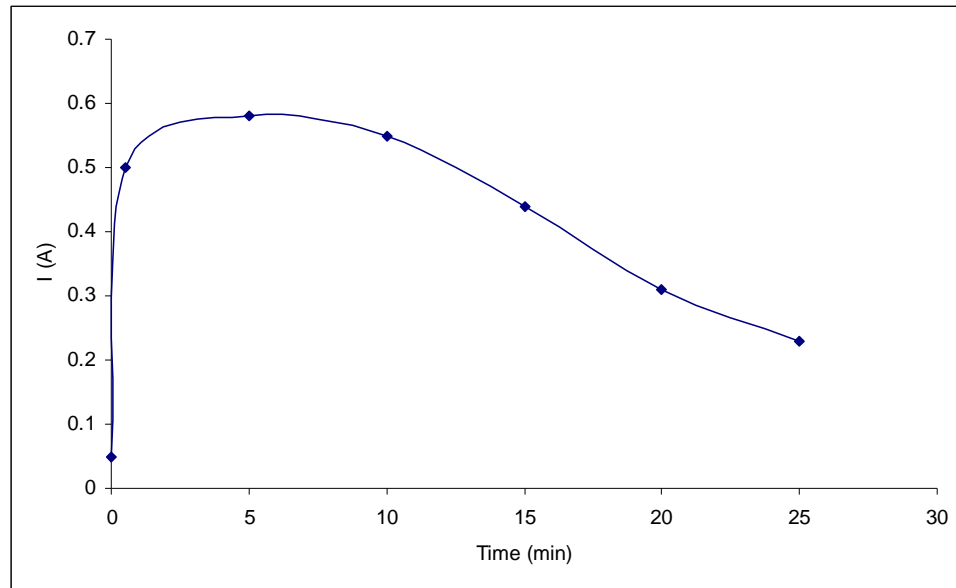

	0 min	0.5 min	5 min	10 min	15 min	20 min	25 min
Current (A) average	0.05	0.5	0.58	0.55	0.44	0.31	0.23

Fig. 5.3 Current vs. batch residence time

The drop in electrolyser current (Fig. 5.3) between 5 and 25 min also revealed changing conditions in the electrolyser over time. The main factors contributing to this process would be loss of chloride concentration via its conversion to chlorine, as well as loss of chloride through its dilution and diffusion of chloride through the membrane.

Figs. 5.4-5.6 (overleaf) show the figures of merit for the different batch residence times. As might be expected, salt efficiency peaks with chlorine yield at 10 min with a highest efficiency of 4.5 kg NaCl/ kg Cl₂ and 37% material yield (Fig. 5.4). Therefore, 63% of the salt contained within the batch did not yield chlorine that could be collected i.e. this figure reflects the sum of the salt that did not react at the electrodes plus that which yielded chlorine that was lost. Also as expected, power and current efficiency (Figs. 5.5-5.6) were highest at 5 min at ~4 W.h/ kg Cl₂ and ~76% current efficiency: i.e. due the higher chloride concentration and lower accumulation of hydroxide ions at this period.

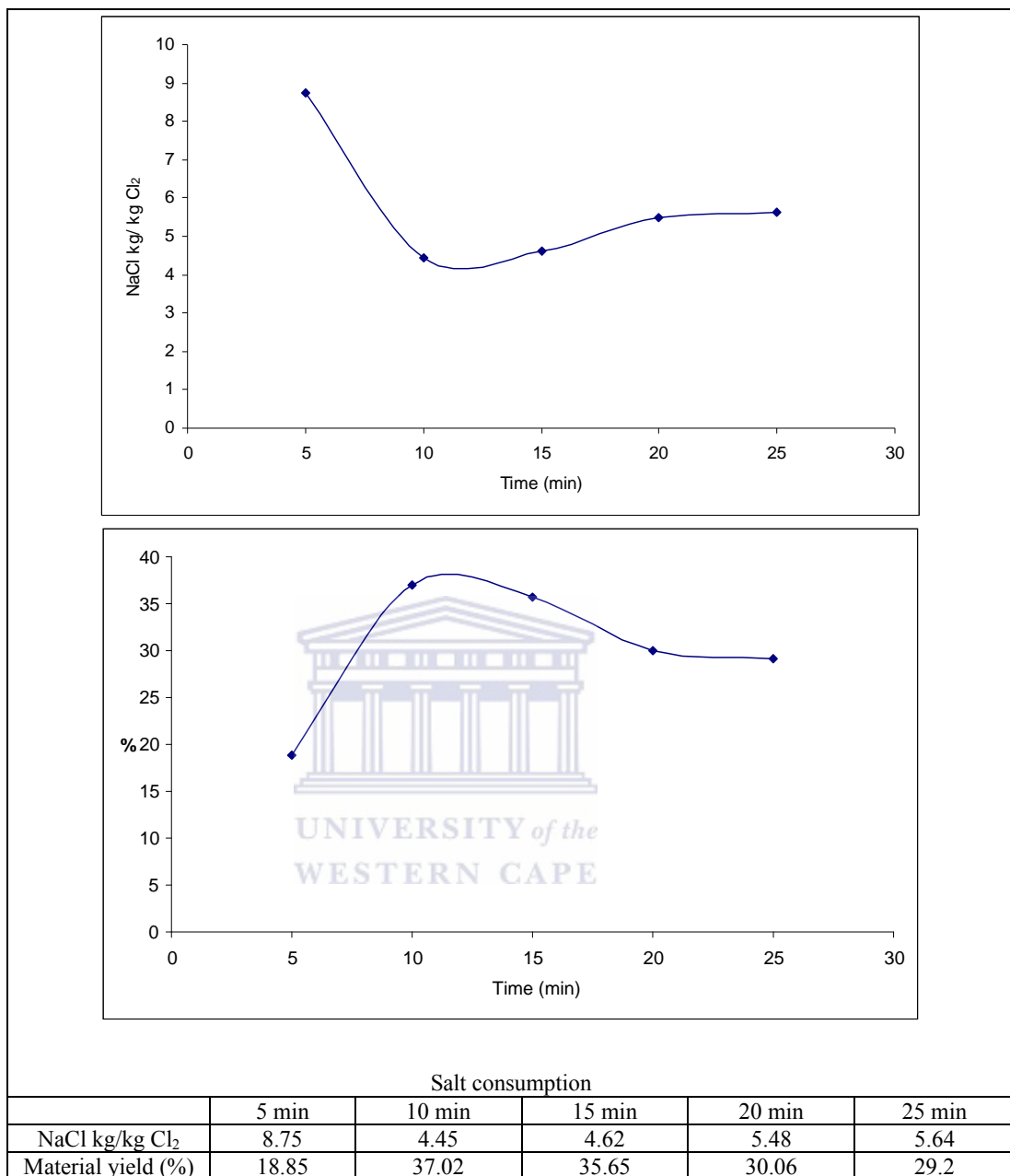
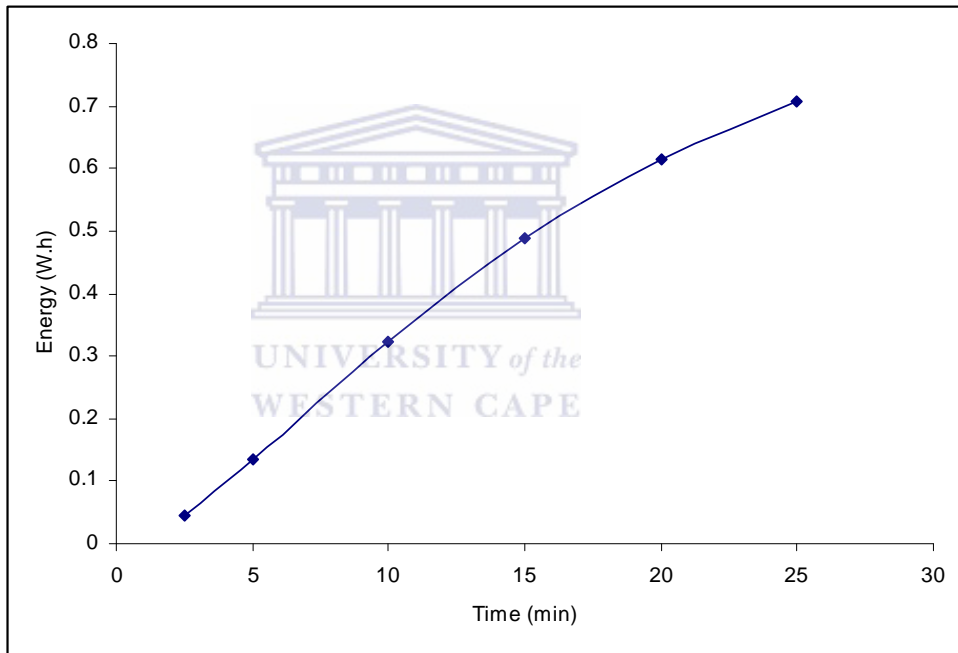
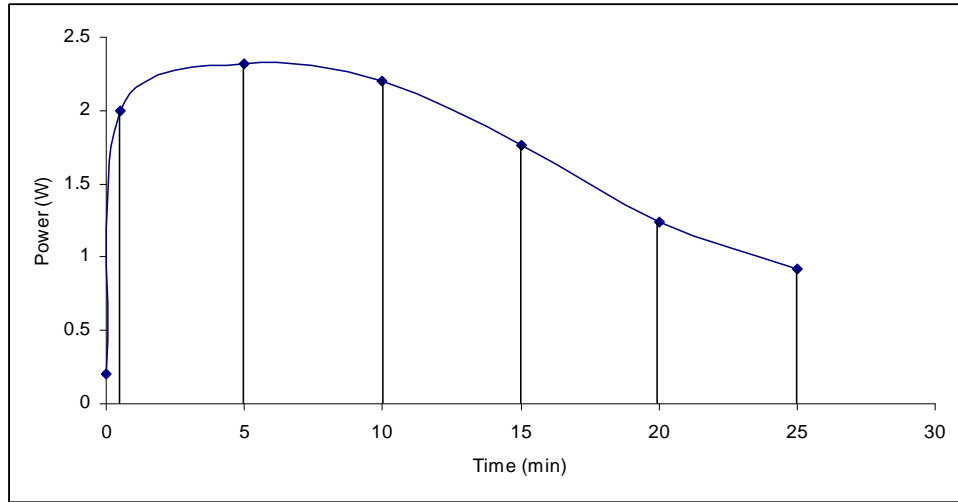
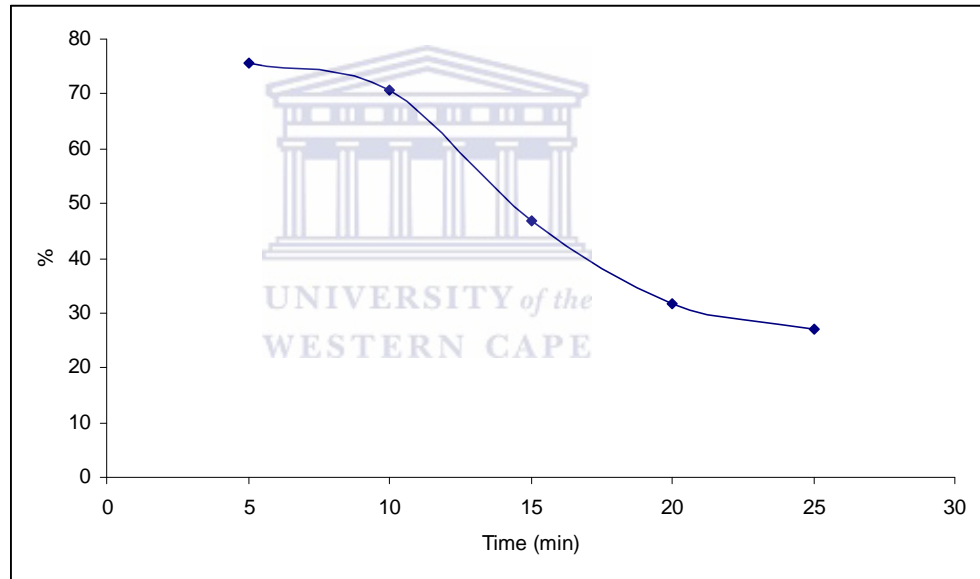
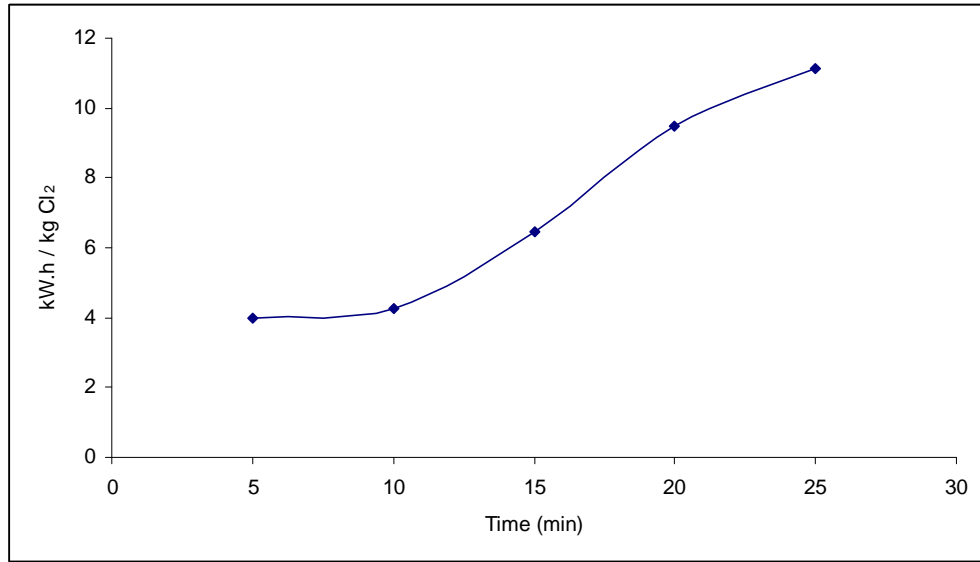

Fig. 5.4 Salt consumption (above) and material yield (below) vs. batch residence time



	0 min	0.5 min	5 min	10 min	15 min	20 min	25 min
Power (W)	0.2	2	2.32	2.2	1.76	1.24	0.92
Energy Wh	-	0.0458	0.1352	0.3228	0.4891	0.6136	0.7065

Fig. 5.5 Integral calculation of energy consumption from electrical power vs. batch residence time (using MS-Origin® software).



Power and current efficiency					
	5 min	10 min	15 min	20 min	25 min
Power kWh/kg Cl ₂	3.994	4.265	6.463	9.496	11.129
Current (%)	75.62	70.8	46.72	31.8	27.14

Fig. 5.6 Power and current efficiency vs. batch residence time

Conclusions:

Peak chlorine yields occurred between 5 and 15 min of batch residence time in the electrolyser. Continued electrolysis after 15 minutes was clearly wasteful in energy and resulted in loss of chlorine and wastage of salt. Further analysis could determine exactly where between 5 and 15 minutes the peak chlorine yield occurred (see below).

5.2.3.2 An optimal batch residence time between 5 and 15 min

To establish where between 5 and 15 min a peak chlorine yield is produced, batch residence periods of 6, 8, 10, 12 and 14 min were evaluated (see below) for chlorine yield and current using the previous protocol (section 5.2.3.1).

Results and discussion:

Fig 5.7 and Table 5.1 (overleaf) show that within the 6-14 min time range, an 8 min batch residence time produced the highest chlorine yield averaging at ~5.7 g/L. This period also produced an exceptionally high current efficiency of ~88%: higher than the previously measured efficiency at 5 min of 75%. If the 8 min value is placed on the previous 5-25 min current efficiency graph (Fig. 5.6), it jumps sharply upwards from the dropping trend line, and therefore does not appear to fit. This probably represents variations between the experimental conditions, and the degree of error in the experimental measurements.

Conclusions:

Given that a degree of error and experimental variation may be present in these results a safe conclusion would be that a maximum chlorine yield between 5.6-5.8 g/L occurred between 8 and 12 minutes with the corresponding figures of merit (Figs. 5.4 and 5.6).

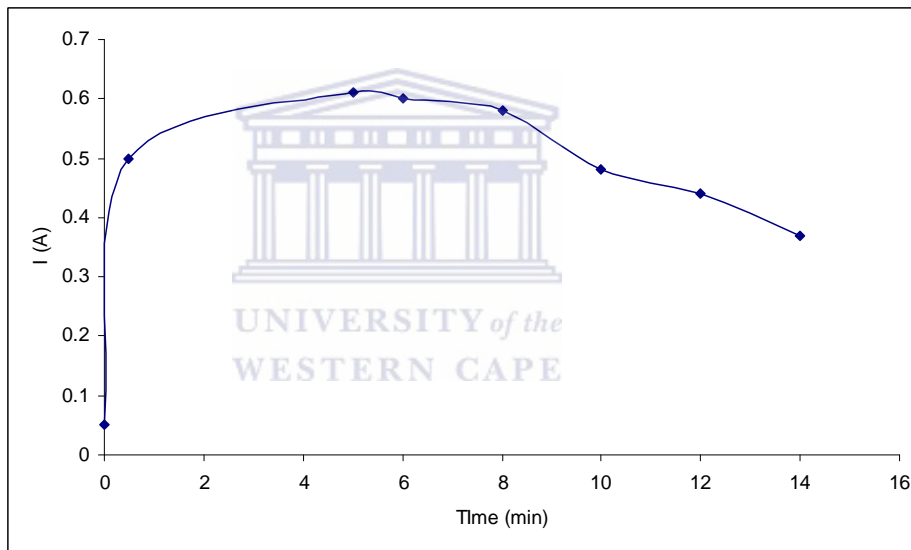
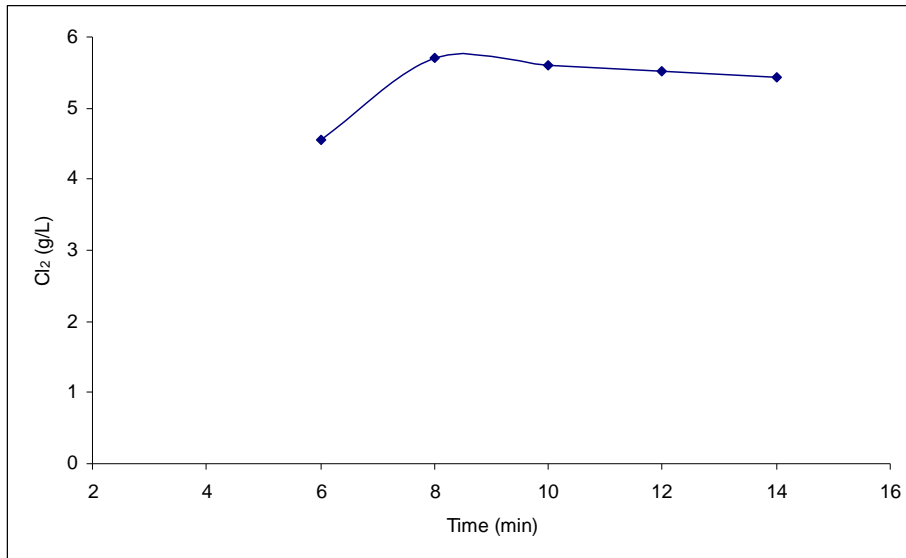

Chlorine concentration (g/L)							
	6 min	8 min	10 min	12 min	14 min		
Batch 1	4.56	5.75	5.61	5.5	5.51		
Batch 2	4.49	5.81	5.63	5.46	5.44		
Batch 3	4.59	5.57	5.55	5.6	5.37		
Average.	4.55	5.71	5.6	5.52	5.44		
Current (A) average							
0.0 min	0.5 min	5 min	6 min	8 min	10 min	12 min	14 min
0.05	0.5	0.61	0.6	0.58	0.48	0.44	0.37

Fig. 5.7 Chlorine production (above) and current (below) vs. batch residence time

Cl ₂ (g/L)	Salt efficiency NaCl kg/kg Cl ₂	Material yield (%)	Power efficiency kWh/kg Cl ₂	Current efficiency (%)
5.71	4.39	38.26	3.427	88.14

5.2.4 Comparison of batch and plug flow supply methods

Comparison of chlorine production under batch reactor and plug flow conditions reveals some interesting findings. Optimal chlorine production efficiency for plug flow operation of the electrolyser under ~4 V supply (Siguba, 2004), gave an average chlorine yield of ~6.3 g/L. While this is a higher concentration than 5.7 g/L obtained from the batch method (Fig. 5.7), the overall amount of chlorine produced by the batch method over the same time period (8 min) is more than double that of the plug flow method (see Table 5.2). Furthermore, while the salt efficiency of the batch supply was less than that of continuous flow (by 7%) the energy consumption of the batch supply system was almost half that of the continuous supply method.

	[Cl ₂] at 8 min. (g/L)	Volume at 8 min. (mL)	Cl ₂ at 8 min. (g)	Cl ₂ (g/day)	Voltage (V)	Wh/day	Salt efficiency (kg NaCl / kg Cl ₂)	Energy (kWh/kg Cl ₂)
Batch 15 mL/ 8 min.	5.71	15	0.085	15.4	4	48.2	4.39	3.4
Continuous flow 50 mL/h	6.3	6.7	0.042	7.5	4.2	50.4	4.1	6.7

5.2.5 Conclusions

Batch operation of the electrolyser proved a superior method over plug flow concerning both chlorine production and energy consumption. The main reason for this is because in batch flow operation, the entire chlorine content of the electrolyser is extracted at the point it reaches a peak concentration. In contrast the plug flow method can reach a

higher concentration but at the expense of production rate and energy consumption. Therefore, the trade off in favour of batch conditions is a slight loss in salt efficiency for considerable (double) gains in chlorine production rate and energy efficiency. Furthermore, providing that a system for its control could be devised (see Chapter 6, section 6.2.1), the batch supply system solved the problem of controlling slow flow rates and mixing of catholyte and anolyte on standing (section 5.2.1).

5.3 EVALUATION OF MEMBRANE FUNCTION

The function of the membrane was previously shown to improve the efficiency of brine electrolysis over that of undivided cells (Linkov, 2002; Bashtan, *et al.*, 1999). However, membranes are prone to blockage by particulate matter and scale deposits, which diminish their function. Therefore, in the event that this became a problem, it was important to determine whether an undivided cell of comparable size to the membrane electrolyser could provide a viable substitute. The benefits of constructing such a cell were twofold: it allowed (i) the function of the membrane to be evaluated more accurately, and (ii) a possible alternative electrolyser if membrane blockage became a problem.

5.3.1 Construction of an undivided electrolyser

For an accurate evaluation of membrane function, the proposed undivided electrolyser needed to maintain as many of the original dimensions of the membrane electrolyser as possible. Simply removing the membrane would create a large single chamber of ~100 mL, which would dramatically change the dynamics of the cell. Therefore, to maintain the 15 mL volume of the original anolyte chamber, the spiral cathode was substituted for a stainless steel pipe cathode with similar dimensions to the membrane. The anode was placed inside the cathode and secured with pipe adaptors at the top and bottom. The pipe thus became the cathode and casing of the electrolyser (Fig. 5.8). The electrolyser was run in a side by side experiment with the membrane electrolyser and evaluated for chlorine production (see below).

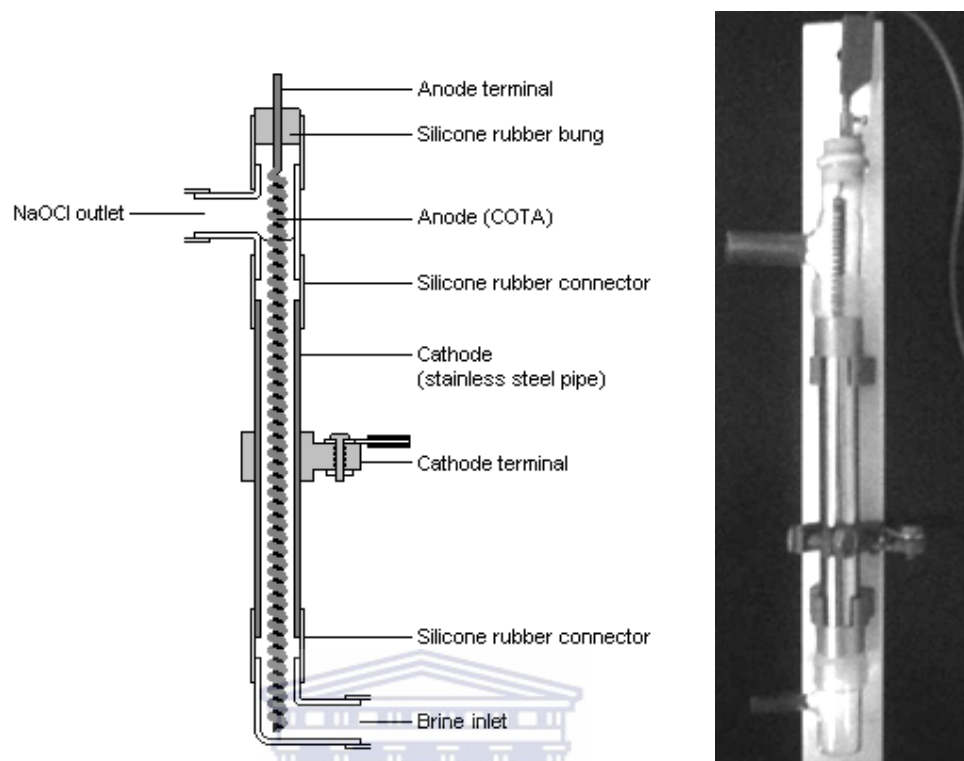

Fig. 5.8 The undivided electrolyser: developed as a possible alternative to the membrane electrolyser.

5.3.1.1 Comparison of electrolyser function

A comparison of the two electrolysers was made using the 8 min batch supply conditions previously established (section 5.2.3.1). Operation of the undivided electrolyser required a lower voltage due to the absence of the membrane. Here, a voltage yielding a peak current matching that of membrane electrolyser (between ~0.5-0.6 A) was selected to allow an accurate comparison of the two electrolysers (see below).

Results and discussion:

Table 5.3 (overleaf) shows that the undivided electrolyser required only 3 V to maintain a 0.5 A current between the electrodes. At 4 V the undivided electrolyser became very hot and produced current values above 1 A (data not shown). Chlorine production under

these conditions was not investigated because heat favours chlorate production and results in loss of chlorine (see Chapter 2, section 2.4.2).

The chlorine yields from operation at 0.5 A show that chlorine was produced $\sim 2 \times$ faster by the membrane electrolyser consuming $\sim 2 \times$ less salt and energy. In addition, the undivided cell was found to produce a maximum chlorine concentration of 6 g/L after 15 min running and less than 2 g/L at 5 min running time (data not shown). Therefore, chlorine concentration peaked later in the undivided cell than in the membrane cell. However, neither of these values came close to matching either the salt or power efficiency of the membrane electrolyser.

TABLE 5.3 COMPARING MEMBRANE AND UNDIVIDED ELECTROLYSERS

Cell type	Voltage (V)	Cl ₂ conc. (g/L)	Cl ₂ /batch (mg)	Cl ₂ (g/day)	W.h/day	Salt efficiency kg NaCl/kg Cl ₂	Energy consumption (kWh/kg Cl ₂)
Membrane electrolyser	4.1	5.68	85.5	15.4	49.2	3.5	3.1
Undivided electrolyser	3.0	2.6	38.3	7.0	36.0	7.81	5.2

Fixed conditions: Electrolysis period = 8 minutes; Brine concentration = 25 g/L; Brine volume = 15 mL; Current: 0.5 A.
n = 2 (n = no. of chlorine readings in g/L for each average shown above)

It should be noted that the undivided cell did not have the same spiral wire cathode as the membrane electrolyser, and did in fact have a larger cathodic surface area for back reactions to occur. Concerning its operation, a further point of interest is whether the steel cathode would corrode in the environment of brine and hypochlorite. However, while acting as a cathode during electrolysis the steel would be far less susceptible to oxidation and following this it would be safe after the electrolyser was flushed with water. Therefore, in combination, cathodic protection and water flushing may prevent the steel pipe cathode from corrosion.

5.3.2 Conclusions

The inclusion of the membrane in the electrolyser operating under batch conditions provides a faster more efficient means of producing chlorine. The undivided cell was $\sim 2 \times$ slower and $\sim 2 \times$ less energy and salt efficient at producing chlorine, most likely reflecting a high degree of back reaction of chlorine product on the electrodes. Further experiments could determine whether the membrane's effects might be supported by the spiral cathode. However, for practical purposes the pipe cathode provides a possible alternative electrolyser that is cheap to construct, easy to assemble, and of potential use if and when membrane blockage becomes a problem.

5.4 THE EFFECTS OF MEMBRANE BLOCKAGE

Due to the variable quality of rural water sources, possible blockage (fouling) of the membrane was of major concern to the project. Membrane blockage increases the electrical resistance across the cell and results in lower chlorine yields. High levels of turbidity, organic matter, and water hardness were all considered potential causes of membrane blockage (Chapter 2, section 2.4.7).

5.4.1 The membrane and turbidity

Turbidity was a prime suspect in loss of electrolyser function during the later testing of the disinfection system at a rural site (Chapter 7 section 7.7). Here, turbidity dramatically increased in summer and autumn, from < 5 FNU to 120 FNU. This coincided with a 0.1-0.3 A drop of current within the electrolyser, which due to the design of the dosing system could have been caused by water that flushes through the electrolyser (Chapter 6, section 6.2.2.1). Therefore, to determine whether turbidity had affected membrane function the following experiment was carried out.

5.4.1.1 Effect of turbidity on membrane function

An exact simulation of the pilot site's batch dosing system would have proved difficult and time consuming to obtain results. Therefore, a continuous flow supply was chosen, wherein turbidity could be introduced at controlled levels to both the brine and water

supply to the electrolyser. A range of turbidity could then be tested over different periods of electrolysis time against a control with low turbidity, and its effects on current and chlorine production be evaluated.

Method:

Turbidity in the pilot site's water was used for the experiment and could be concentrated or diluted drawing from stock samples of water where the turbidity had precipitated. Turbidity was measured in FNU using a portable turbidity test kit (Chapter 4, section 4.2.3). Flow rates of brine and water to the electrolyser were maintained at 50 mL/h and 140 mL/h respectively (Chapter 4, section 4.1). Voltage was set at 4 V over the one-week continuous running period.

Results and discussion:

Table 4.6 shows that turbidity at ~120 FNU dramatically reduced chlorine yields. On the other hand the current was far less affected at ~120 FNU, and after 24 h remained on par with that of the low FNU experiment. However, after one week of continuous running at ~120 FNU the current dropped to 0.33 A, (a 35% current reduction).

The reduction in chlorine yields was most likely caused by the chlorine demand of the turbidity itself and possible additional reactions taking place at the electrodes from the reaction products with turbidity. The loss of current after one week indicated that there had been a cumulative effect on the membrane or even the electrodes.

5.4.2 Recovery of the membrane

In order to test whether the membrane used at 120 FNU for one week had been permanently blocked by the turbidity, it was removed from the electrolyser and thoroughly washed with tap water. No permanent staining had occurred. It was then installed in an electrolyser with a clean water supply and brine supply of < 1 FNU and run under the same electrolysis conditions as were used in the turbidity experiment.

		10 min	1 h	24 h	1 week
~120 FNU	Current (A)	0.51	0.56	0.6	0.33
	Chlorine (g/L)	1.2	0.8	1.0	0.2
~10 FNU	Current (A)	0.48	0.56	0.41	0.51
	Chlorine (g/L)	5.9	5.2	5.0	5.3
<1 FNU	Current (A)	0.62	0.58	0.52	0.6
	Chlorine (g/L)	7.4	6.2	5.9	6.1

Fixed conditions: Catholyte feed 140 mL/h; Anolyte feed 50 mL/h; Voltage 4 V.
n = 2 (n = no. of chlorine readings in g/L for each average shown above)



Fig. 5.9 Turbid water from the site. Left: After 5 days standing (~10 FNU). Right: fresh from the tap (~120 FNU).

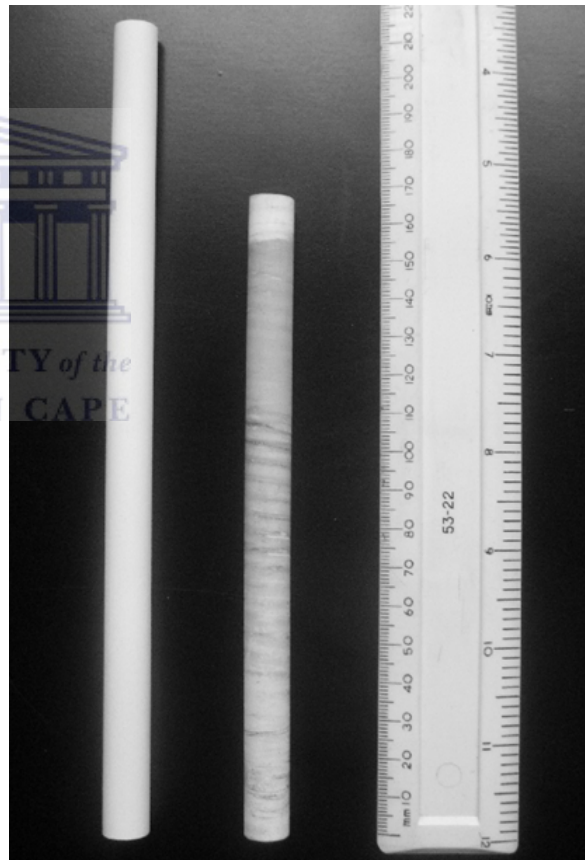

Fig. 5.10 Membrane discoloration: Left: a new membrane as bought from the supplier. Right: a membrane cut to fit the electrolyser, showing staining after six months of use.

A current of ~0.5 A and a chlorine yield of 6.1 mg/L were obtained from the first run of this experiment. Therefore, the effects of 1-week's running with turbidity at 120 FNU was reversible by washing of the membrane. This suggests that the blockage was colloidal in nature and did not form a tightly bound deposit (i.e. as might be expected from lime scale). However, it is possible that running the membrane for even longer periods at high FNU values could more permanently block its pores.

5.4.4 Conclusions

The high level of turbidity used in the experiment reduced current by 35% after 1 week running. This effect would no doubt worsen over a longer running period. However, at low turbidity of < 5 FNU (suitable for chlorine dosing), the effect was not observed and would probably take much longer to block the membrane than at higher turbidity. This correlates with the successful operation of the electrolyser at the site during periods of low turbidity (Chapter 7). It was also noticed that during the operation of the electrolyser at the site (during a two-month winter period of low turbidity, see Chapter 7) the membrane had become stained by orange coloured deposits (most likely iron) but these had had no notably affect on the current of the electrolyser. The discolouration can be seen in Fig. 5.10 as a banding pattern on the membrane. No such bands developed on the new membrane used in the turbidity experiments. Therefore, the two phenomena are probably unrelated, and the effect observed in the turbidity experiment is likely due to a reversible colloidal adsorption of suspended particles.

5.5 CONCLUSIONS TO CHAPTER 5

- A short (eight minute) batch supply of fresh brine and water to the electrolyser proved to be a $\sim 2 \times$ more energy efficient and rapid means of chlorine production than a slow continuous brine feed.
- The batch brine supply method produced a chlorine yield of 15.6 g/day using ~ 50 W.h, which could be supplied by a 10 W solar panel system.
- An undivided electrolyser (based on a stainless steel pipe cathode and COTA anode) provides a slower, less efficient (in both salt and energy consumption) but potentially viable alternative to the membrane electrolyser, which could be used if membrane fouling becomes a problem.
- The membrane can be blocked by turbidity of ~ 120 FNU within its supply feed after one week of running, and to the extent studied here the blockage is reversible by washing the membrane in clean water.

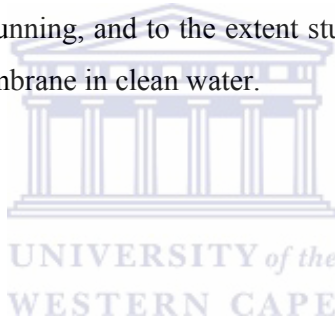

CHAPTER 6

DEVELOPMENT OF THE ELECTROCHLORINATION SYSTEM

This chapter presents the laboratory development and testing of the disinfection system in the following sections: development of a batch dosing system (section 6.1); operation of the batch dosing system (section 6.2) and considerations for rural use (section 6.3).

6.1 DEVELOPMENT OF A BATCH DOSING SYSTEM

6.1.1 A water-powered brine batch

A water-powered means of batch dosing brine to the electrolyser was devised (Fig. 6.1). Here, the brine batch supply system is powered by the filling of the water tank beneath it. As the tank fills, the volume of brine in tube 3 is forced into tube 4 by air pressure generated in the inverted tube 5. The brine dose falls into tube 4 and displaces the contents of the electrolyser. When the water tank empties, brine in the constant head tank 2 feeds into tube 3 and the system is re-set.

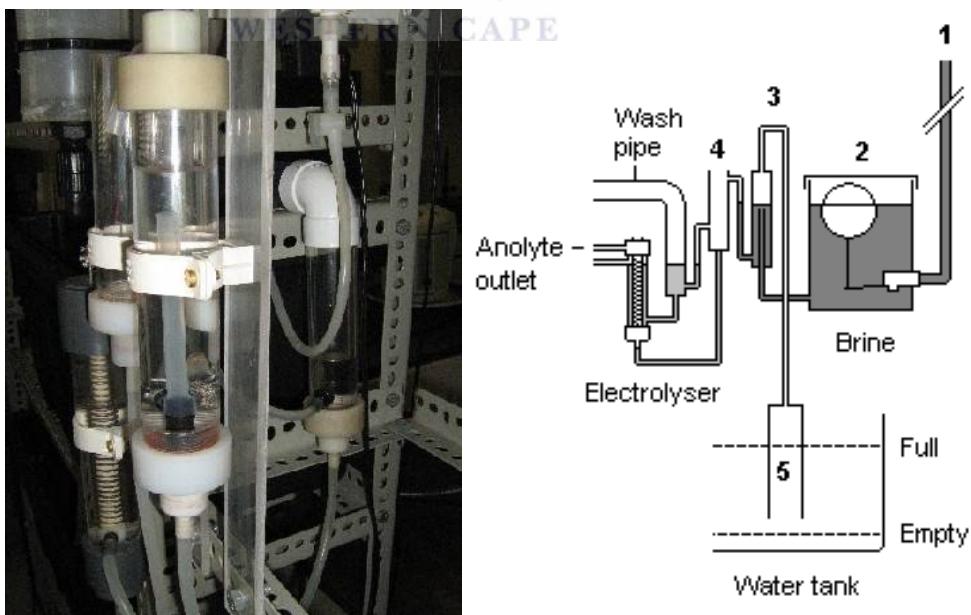

Fig. 6.1 A water-powered brine batch supply system. Left: photograph showing tube 3. Right: schematic diagram of the entire unit.

The wash pipe (Fig. 6.1) forms part of the electrolyser's flush system, which flushes both the cathode chamber and the anode chamber. These components can be understood in context of the complete water dosing system described below.

6.2.2 A complete batch dosing system

The system shown below (Fig. 6.2) was developed to continuously dose 30 L batches of water. It comprises a mixture of electrical and water-powered control. The electrical components consist of two small solenoid valves V1 and V2, a timer, three float switches (S1-3) and a circuit box. Valves V1 and V2 control the release of air from the bells above the U-bend siphons, which causes them to flush water into the tank below. The system chlorinates water through the following sequence:

1. When tank 1 is full (detected by S1) and tank 3 is empty (detected by S3), V2 is opened and tank 2 flushes into tank 3.
2. The filling of tank 3 forces a fixed volume of brine into the electrolyser and starts an 8-min electrolysis period of brine residence in the electrolyser
3. The 8 min period is timed by the "delay on" timer activated by S2 when tank 2 is empty
4. After 8 min of electrolysis, the timer opens V1 and flushes tank 1 into tank 2 (note: some water is diverted to flush out the electrolyser and displace hypochlorite into tank 2)
5. Once tank 2 is full it will only flush again if tank 1 is refilled and tank 3 has emptied

Note: the valves automatically close after flushing due to circuit breaking by the float switches.

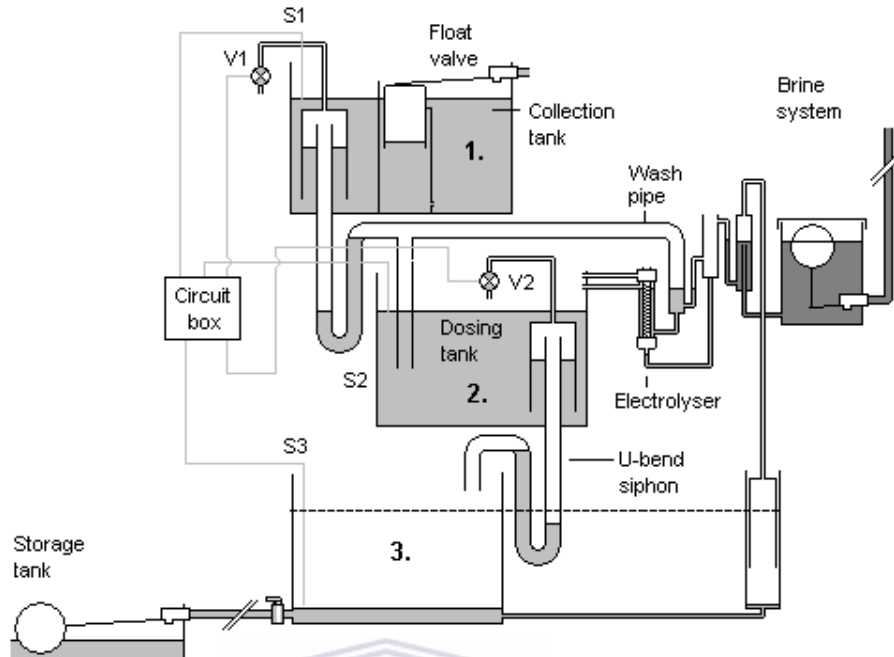

Fig. 6.2 A three-tank batch dosing system.

6.2.2.1 Control of brine electrolysis and hypochlorite dosing

The batch dosing system initiates electrolysis by supplying the electrolyser with brine (Fig. 6.1 above), and stops electrolysis by flushing it with water (Fig. 6.3 below). Due to the low conductivity of water, electrolysis is effectively stopped and the electrolyser remains inactive until another batch of brine is delivered. The system therefore controls both hypochlorite production and dosing by the availability of water in tank 1 and the requirement for water in tank 3. The concentration of hypochlorite (i.e. the combined anolyte and catholyte) is controlled at three levels: (i) the electrolysis period; (ii) the voltage on the electrodes and; (iii) the volume of brine delivered to the electrolyser. All three parameters can be adjusted independently.

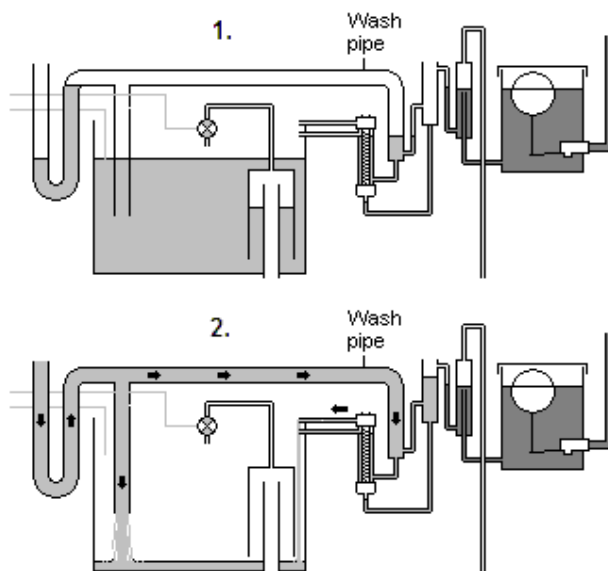

Fig. 6.3 The electrolyser's flush system. 1. Prior to flush. 2. Flushing.

6.2.2.2 Control of water flow rate

The movement of water through the system is controlled by the float switch / timer / solenoid valve circuit. The system responds to the availability of water in tank 1 and the requirement for water in tank 3 which connects to the chlorinated water storage tank via a float valve (Fig. 6.2 above). Tank 3 thus allows the level of water in the storage tank to be detected.

Tank 1 contains a float valve to control incoming water. The valve arm rests on a detached float that moves up and down in a pipe (Fig. 6.4). The pipe has a small hole at its base that allows water to escape at a slower rate than the flush of the tank. This arrangement serves to delay the opening of the float valve until the tank has completely flushed. The delay is important because it allows the flush siphon to properly break, and it also ensures that a fixed volume of water (30 L) passes through the system on each cycle.

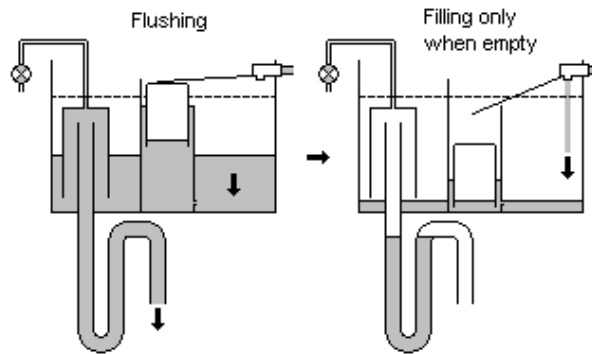

Fig. 6.4 Float valve delay mechanism.

6.2.2.3 Chlorine contact time

Chlorine contact time occurs between the dosing tank and the storage tank. Here, the minimum time period for water to travel between the two tanks must be 20 minutes. This allows sufficient chlorine contact time (CCT) (Carlsson, 2003) before the water reaches a storage tank, where dilution may occur particularly if the water is not being used. The easiest way for this to be achieved is by choosing an appropriate pipe length between the dosing tank and the storage tank (Chapter 7, section 7.2.3).

6.2.3 Solenoid valve specifications

The solenoid valves (Fig. 6.5) were purchased from Hydraelectric© (UK) and have the model specification name of “Hot water dispense valves”. The model was recommended by the supplier because of its durability, which was preferable for prolonged usage. The valve seat is made of silicone rubber and heat resistant ceramic material. The valves operate on 24 V DC at 10 W and are opened on activation and closed on deactivation (standing).

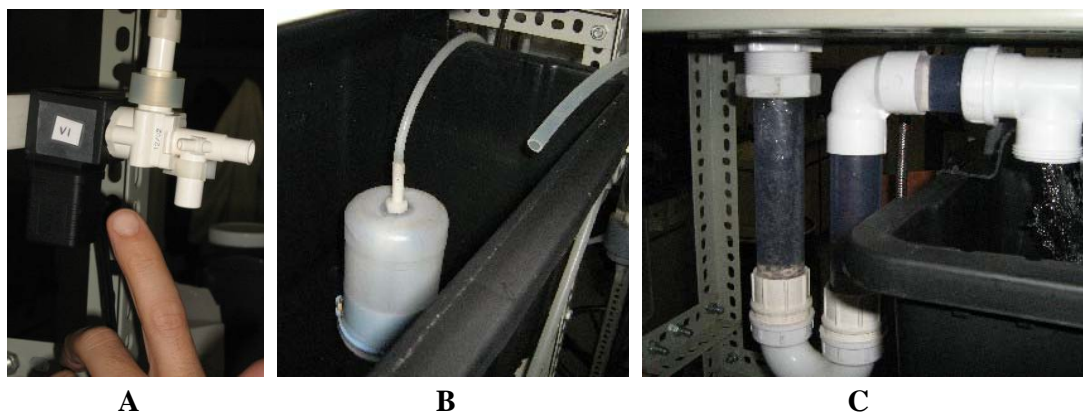

Fig. 6.5. Tank flushing mechanism: A. solenoid valve V1. B. Air bell of a U-bend flush. C. U-bend flush in action.

6.2.4 Conclusions

The batch dosing system presented above uses minimal electrical power and was constructed from commonly available materials, thus fulfilling the aims of minimising construction and running costs. The novel components of the system are: the U-bend flush control mechanism; the brine supply system; and the concept of continuous small batch supply for flow-through hypochlorite dosing and electrolyser flushing. The system therefore required a thorough testing period in the laboratory to determine the reliability of its components and its ability to provide a reliable hypochlorite dose to water (see below 6.3).

6.3 TESTING THE BATCH DOSING SYSTEM

6.3.1 Control of water

In order to test the reliability of the system's water control, it was connected to the mains water in the laboratory via the top tank's float valve. Simulation of water use from a storage tank was achieved by placing a tap on the outlet of the bottom tank (tank 3) and setting it to slowly drain. This way the system could be left running over night in the laboratory and stopped and started by opening and closing the tap. The system was

left “on” in this manner for more than 6 months, proving that it could control water reliably on demand.

6.3.2 Electrical current readings

Current readings came as spikes corresponding to the presence of brine in the electrolyser and consequent electrolysis. On receiving brine the electrolyser’s current quickly spiked to a mean reading of $\sim 0.5\text{-}0.6$ A. Following the flushing of the electrolyser with water after 8 min, the current sharply dropped to an average resting state of $0.005\text{-}0.01$ A, reflecting the poor conductivity of water.

6.3.3 Chlorine dosing

The chlorine (FAC) concentration of the dosed water was measured from samples taken from the dosing tank (tank 2). Because the water already had a chlorine residual of 0.1 mg/L from the tap, its demand was very low. Each dose of chlorine gave an immediate reading of between $\sim 3.5\text{-}4.0$ mg/L upon mixing with the 30 L batch of water. Given that tap water has a very low chlorine demand, the concentration of the chlorine from the electrolyser was calculated to be $\sim 6\text{-}7.0$ g/L.

Different dosing concentrations of chlorine could be achieved by changing the setting of the timer. E.g., using a 5 min time setting in place of 8 min, the electrolyser produced chlorine at $\sim 2.0\text{-}4.0$ g/L giving a $\sim 1.0\text{-}2.0$ mg/L after dosing to the 30 L batch of water. This however, was wasteful regarding salt efficiency i.e. unconverted brine was wasted. Therefore, to improve salt efficiency for low chlorine dosing concentrations, the volume of brine entering the electrolyser was reduced and electrolysis time maintained at 8 min. This was achieved by slightly raising tube 4 (Fig. 6.1) so that it delivered less brine to the electrolyser.

6.3.4 Electrical energy consumption

The two components in the system that consumed the most energy were the electrolyser and the solenoid valves. With a constant demand for water and constant water availability, the system consumed ~ 50 Wh of energy over 24 h (Table 6.1). Therefore, a

20 W solar panel producing 120 Wh /6 h could easily power the entire system run at maximum demand.

Component	Time ON	Current (A)	Volts (V)	Power (W)	Energy (Wh)
Electrolyser	8 min	0.5	4	2	0.267
Solenoid valve V1	5 sec	0.42	24	10	0.014
Solenoid valve V2	5 sec	0.42	24	10	0.014
Total energy/batch (1 × batch = 30 L of water)					0.291
Total energy/h (7.5 × batches = 225 L of water)					2.183
Total energy/day (180 × batches = 5400 L of water)					52.38

6.3.5 Inputs and outputs

Continuous operation of the system at a ~4 mg/L chlorine dose on an eight minute batch cycle with a maximum rate of water use (e.g. with the outlet tap left open), had the following inputs and outputs (Table 6.2).

Inputs					
	8 min	1 h	24 h	1 week	1 month
Brine (L)	0.02	0.11	2.70	18.90	75.60
Salt (g)	0.38	2.81	67.44	472.08	1,888.32
Electrical energy (Wh)	0.3	2.3	54	378	1,512
Outputs					
	8 min	1 h	24 h	1 week	1 month
Water (L)	30	225	5,400	37,800	151,200
Anolyte (L)	0.02	0.11	2.70	18.90	75.60
Chlorine (g)	0.15	0.79	16.53	115.80	463.05

6.3.6 Conclusions

The disinfection system reliably responded to demand and availability of water, and provided a reliable hypochlorite dose that was both reproducible and adjustable. Importantly, the electrolyser had maintained its ability to produce hypochlorite consistently over the test period indicating that the anodic material was stable under the conditions of batch dosing. The tests were however conducted with mains water and therefore the real test of the electrolyser's reliability would be its operation at a rural water source of predictably poorer quality.

6.4 CONSIDERATIONS FOR RURAL USE: SCOPE AND LIMITATIONS

The main aim behind the design of the disinfection system was to achieve automation on a small affordable scale for both the brine supply to the electrolyser and control of chlorine dosing to water. The scope and limitations of the final design are discussed below regarding both its mechanical operation and potential for community management:

6.4.1 Water pressure limitations

The system operates at “open pressure” i.e. where chlorine is dosed to an open head of water at atmospheric pressure. While this facilitated designing water-powered mechanisms, it also removes the potential energy (in the form of pressure) from the water that could be needed for supply purposes.

The limitation is that the water level in the storage tank at ground level must be higher than the level of the taps it supplies. Therefore, the installation site of the disinfection system should either be on ground located higher than that of the taps it supplies, or, where this cannot be achieved (e.g. on flat ground), a raised horizontal-style storage tank could be used at a position between the level of the dosing tank and the taps. Alternatively, on flat ground, the disinfection system and supply tank could be artificially raised (using blocks, low wooden platforms or a mound of earth) to achieve the necessary elevation above the taps.

The operation of the disinfection system also requires sufficient water pressure to reach the inlet pipe of the batch dosing system (at a height of 1.90 m above floor level). How this is achieved at a rural site will depend on the nature of the water supply and its abstraction method, i.e. either by gravity from water sources at higher levels, or by externally supplied energy (e.g. pumping mechanisms).

6.4.2 Chlorination level and dosing rate

The dosing of freshly produced hypochlorous acid with no storage period is a unique feature of the system. This has advantages over stored hypochlorite, but also has a limiting effect on the dosing rate of the system. This is because chlorine production determines the rate at which water can be dosed, i.e. a higher chlorine dose will require more electrolysis time and a longer retention time for each batch of water through the system. If a very high chlorine dose (e.g. $> 7 \text{ mg/L Cl}_2$) is required at a site, this could be achieved by an increase in voltage and a higher concentration of brine; both adjustments would serve to maintain a reasonable dosing rate but at a loss of salt and current efficiency.

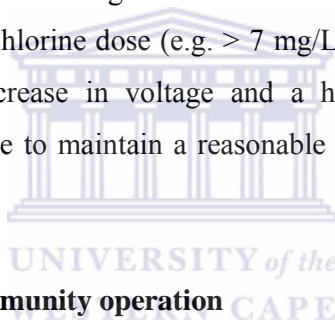

6.4.3 Potential for community operation

The disinfection system is automated in chlorine production and dosing, but still requires diligent maintenance and an effective emergency protocol for if and when it breaks down or ceases to function properly. The ability of the community to manage these aspects of the disinfection system's operation is vital (see below).

6.4.3.1 Maintenance

An operator is required to prepare brine and top up the brine supply tank. The task can be standardised (e.g. using a bucket of water and a measuring cup of salt) and placed in a general weekly checklist for the system's operation, which would also include checking the current reading of the electrolyser and cathode de-scaling if necessary (i.e. cathode cleaning in vinegar to remove scale). A detailed user's manual with operation, maintenance and emergency protocol guidelines would be needed, including contact numbers for further advice and help. The means of purchasing salt would need to be

determined by the community. Determination of changes in chlorine demand of the water and dosing adjustment is potentially a task manageable by the community, but it would require training and a chlorine measurement kit (these tasks are therefore perhaps best suited to a local water authority). The local authority might also need to facilitate the purchase of spare and replacement parts for the disinfection system. Finally a log book for recording system operation and purchasing would also be advisable.

6.4.3.2 Emergency protocol

An effective protocol for responding to system malfunction is a vital. System malfunction could expose the community to waterborne disease, and therefore should be dealt with in a swift and efficient manner. The first step in the procedure would be to close both the inlet and outlet taps of the disinfection system. The user's manual would then assist in problem identification and response. A local authority (e.g. a plumber with knowledge of the system) might need to facilitate fixing the problem but it would also be of benefit if the community owned an appropriate tool kit and set of spare parts for fixing basic problems.

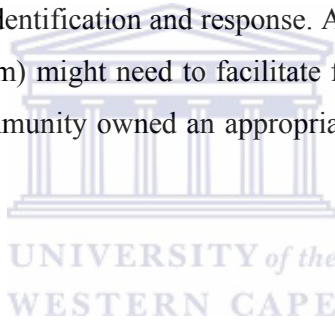

6.5 CONCLUSIONS TO CHAPTER 6

- The disinfection system operates automatically in response to water demand (i.e. consumption) and water availability.
- The disinfection system has water-powered components and is designed for chlorine dosing to water at atmospheric pressure.
- The chlorine dose constitutes freshly produced hypochlorous acid of negligible chlorate content.
- Chlorine dosing can be controlled at three levels: (i) adjustment of electrolysis time (ii) adjustment of brine supply volume and (iii) adjustment of current supply.
- Both the brine supply to the electrolyser and chlorine dose to the water are powered by water moving through the system.
- Timing of brine electrolysis and water flushing control are powered electrically by components that use $\sim 1/10^{\text{th}}$ of the power required by the electrolyser. This reduces the solar panel requirements that otherwise would considerably raise the capital cost if electric pumps were to be included.
- A 10-20 W solar panel system is sufficient to supply the entire system's electrical energy requirements.
- Community maintenance and emergency response protocols are required.

CHAPTER 7

RURAL OPERATION OF THE SYSTEM

This chapter presents the pilot study of the installation and testing of the disinfection system at a rural site in the Western Cape. An overview of the project site and test period is given below (Table 7.1).

TABLE 7.1. OVERVIEW OF PROJECT SITE & PROJECT PERIOD	
Rural site	
Location:	Worcester, Western Cape
Location's name:	Oude Wagon Drift farm
Location's type:	Fruit and dairy farm
Community occupation:	Farm workers
Community size:	18 households (~110 people)
Pre-existing water supply	
Reticulation:	Household taps
Storage:	3 × 2,000 L raised storage tanks
Supply to tanks:	Farm irrigation pipeline (at 3-bar pressure)
Pre-treatment:	Pressurized disc filtration
Water origin:	Breede River
Water catchment area:	Breede River Valley
Local water authority:	WEWUSA
Project period	
Initiation:	January 2008
Installation period:	4 months
Test period:	13 months (May 2008 – June 2009)
Total running period estimated:	7 months
Longest uninterrupted running period:	2 months (July – August 2008)
Stoppage time:	6 months

7.1 SITE SELECTION

The Western Cape, particularly within a day's drive from Cape Town, has relatively few communities dependent on untreated water. However, an appropriate site was eventually found by contacting the Worcester East Water Users Association (WEWUSA) manager, Mr Frikkie Joubert. The WEWUSA pump water from the

Breede River for farm irrigation. This water is also used by the communities of farm workers for all domestic purposes including drinking. With the help of Mr Joubert a farm was selected on which a community of approximately 20 families lives.

To reach the farm (a fruit and livestock enterprise owned by the Naude family, headed by Mr Willie Naude) one travels 6 km from Worcester (two hours' drive from Cape Town) on the N15 (R60) to Robertson turning left at Over Hex crossing for a further 3 km (Fig. 7.1). This farm was therefore chosen as the site for the project as it satisfied the requirements for testing the disinfection system in a rural situation.



Fig. 7.1 Satellite image (~20.3 km altitude) showing the WEWUSA water supply system and project site.

7.1.1 The existing water source

The water source at Oude Wagon Drift farm supplies a farm worker community of ~100 people. The water is pumped directly from the Breede River and on the farm it passes through a series of high pressure ~200 micron disc filters (Fig. 7.2). This supplies 3 × 2,000 L tanks that are elevated above the community houses. The tanks are fed at ~3 bar pressure and each supplies six households (Fig. 7.3) with water for domestic use.



Fig. 7.2 Existing disc filtration system on the farm.



Fig. 7.3 Community households on the farm.

The water is pumped from the Breede River at a site 2 km downstream from an inlet of the Brandvlei dam (Fig. 7.1). The inlet is 2.2 km downstream from a seepage area that receives treated effluent from the Worcester sewage works. Although there was continuous monitoring of the water quality in the river by the Winelands District Municipality, the Worcester East Water Users Association (WEWUSA) had obvious concerns as to the quality of water being supplied to the farm workers. The water is pumped from the river and supplies many farms in that part of the Breede River valley. The pump house is about 15 km from Oude Wagon Drift farm.

During the winter rains and in spring time, there was adequate water in the Breede River to allow pumping for irrigation, however, in summer and early autumn water was added to the river from the Brandvlei dam (Fig.7.1). In those periods the water was much darker in appearance due to suspended solids and it also has an unpleasant odour. This was due to the presence of disturbed sediments from the dam. Clearly there was a need for filtration and disinfection for the water supply to be used as drinking water.



7.2 INSTALLATION OF THE DISINFECTION SYSTEM

For the purpose of the pilot study the disinfection system was intended to operate adjacently to the community's existing water supply. The water from the disinfection system was not intended as a substitute for their existing water, but once established and proven reliable and safe it could offer a source of chlorinated drinking water on the site.

7.2.1 The Installation site

A site was allocated next to an existing water tank positioned on top of a 3 m hill 45 m away from the community housing (Fig 7.4 A and B).

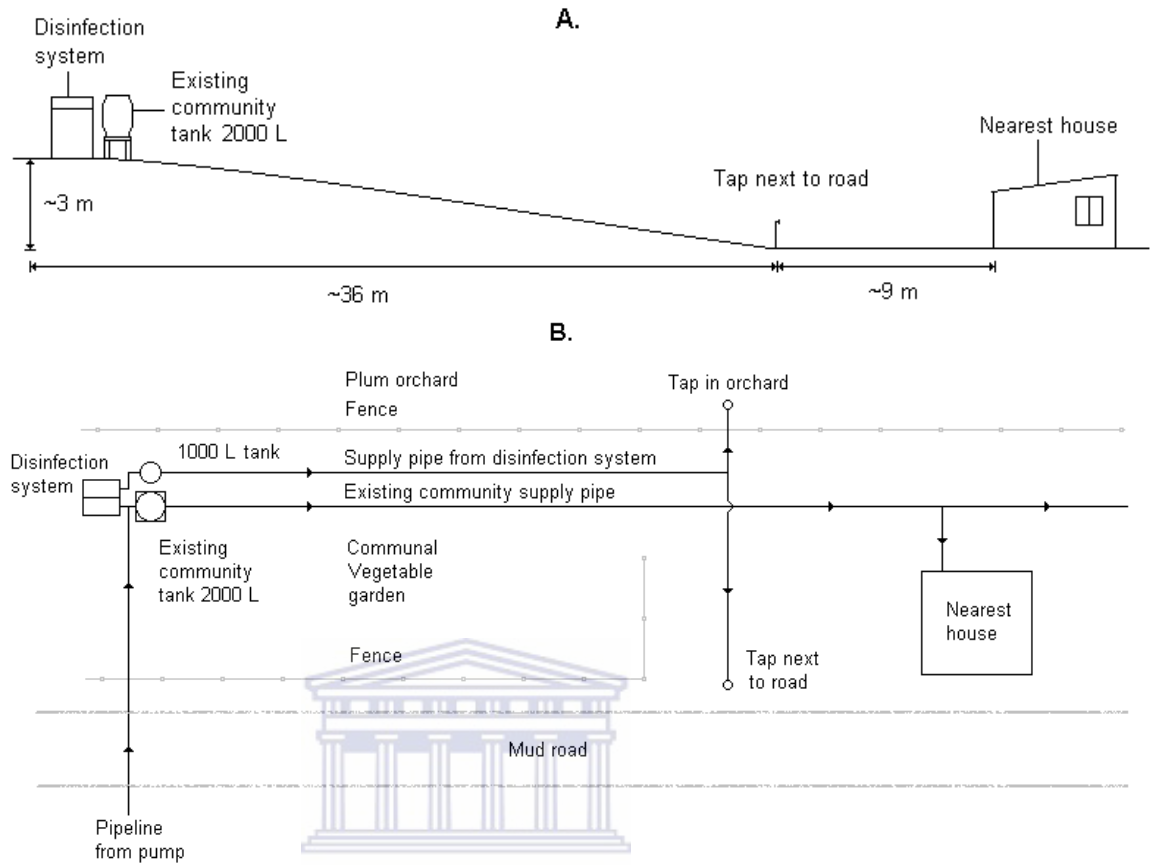

Fig. 7.4 Schematic plan views of site. A. Eye level view. B. Overhead view showing existing pipelines and those of the disinfection system with two taps.

7.2.2 Housing

Construction of the disinfection system began with the installation of a wooden shed with a 4 m² floor space, 2 m wall-height, and corrugated metal roof (Fig. 7.5 A, overleaf). The shed provided sufficient floor space and height to house the batch dosing system, sand filter (Fig. 7.6 A, overleaf) and a security cage for the electrical equipment. The sloping roof of the shed faced due north at an angle of 30°, appropriate for positioning solar panels (Fig. 7.5 A).

7.2.3 Water supply and chlorine contact time (CCT) system

The existing water supply was connected to the disinfection system via a T junction on the inlet pipe of the community water tank (Fig. 7.7, overleaf). This arrangement

allowed the inlet pipe to supply both the existing water tank and the disinfection system simultaneously leaving the existing supply to the households unaffected.

The output pipe from the disinfection system was joined to 60 m of 4 cm diameter pipe with a total volume of ~75 L that was coiled around a 1,000 L plastic “JoJo” tank positioned outside the shed behind the community tank (Fig. 7.5 A and B). The coil provided a 20 minute chlorine contact time (CCT) for each batch of water before it reaches the storage tank. The necessary volume and length of the pipe coil were calculated as follows:

- Flow rate of chlorinated water from dosing tank = 30 L/8 min batch (or 3.75 L/min)
- Pipe volume required for a 20 min retention time = $3.75 \times 20 = 75 \text{ L}$
- Volume of 1 m of a 4 cm diameter pipe ($\pi \times r^2 \times 100/1000$) = 1.257 L
- Therefore, pipe length containing 75 L = $75 \text{ L}/1.257 \text{ L} = \sim 60 \text{ m}$

The outlet of the tank was joined to a 2 cm diameter pipe which led down the hill toward the housing and split 36 m from the shed to feed two taps: one positioned by the orchard (for use by the fruit pickers in autumn) and one next to the road ~10 m from nearest house (Fig. 7.4). The taps remained locked during the initial testing period of the disinfection system.

7.2.3 Batch dosing system and brine supply

The batch dosing system was set up as shown Fig 7.6 B and Fig. 7.7. The brine supply tank was filled with a 25 g/L table salt solution mixed onsite in a 30 L bucket using a 750 g measuring cup. The brine tank is a 40 L semi transparent plastic tank to allow observation of the brine level inside (Fig. 7.6 B).



A



B

Fig. 7.5 Outside the shed. A: Housing of the disinfection system and existing community water tank. B: Chlorine contact time coil (75 L) and the chlorinated water storage tank (1000 L).



A



B

Fig. 7.6 Inside the shed. A: Sand filter. B: Dosing system (left: showing tanks 1 and 2) and brine supply and electrolyser (right).

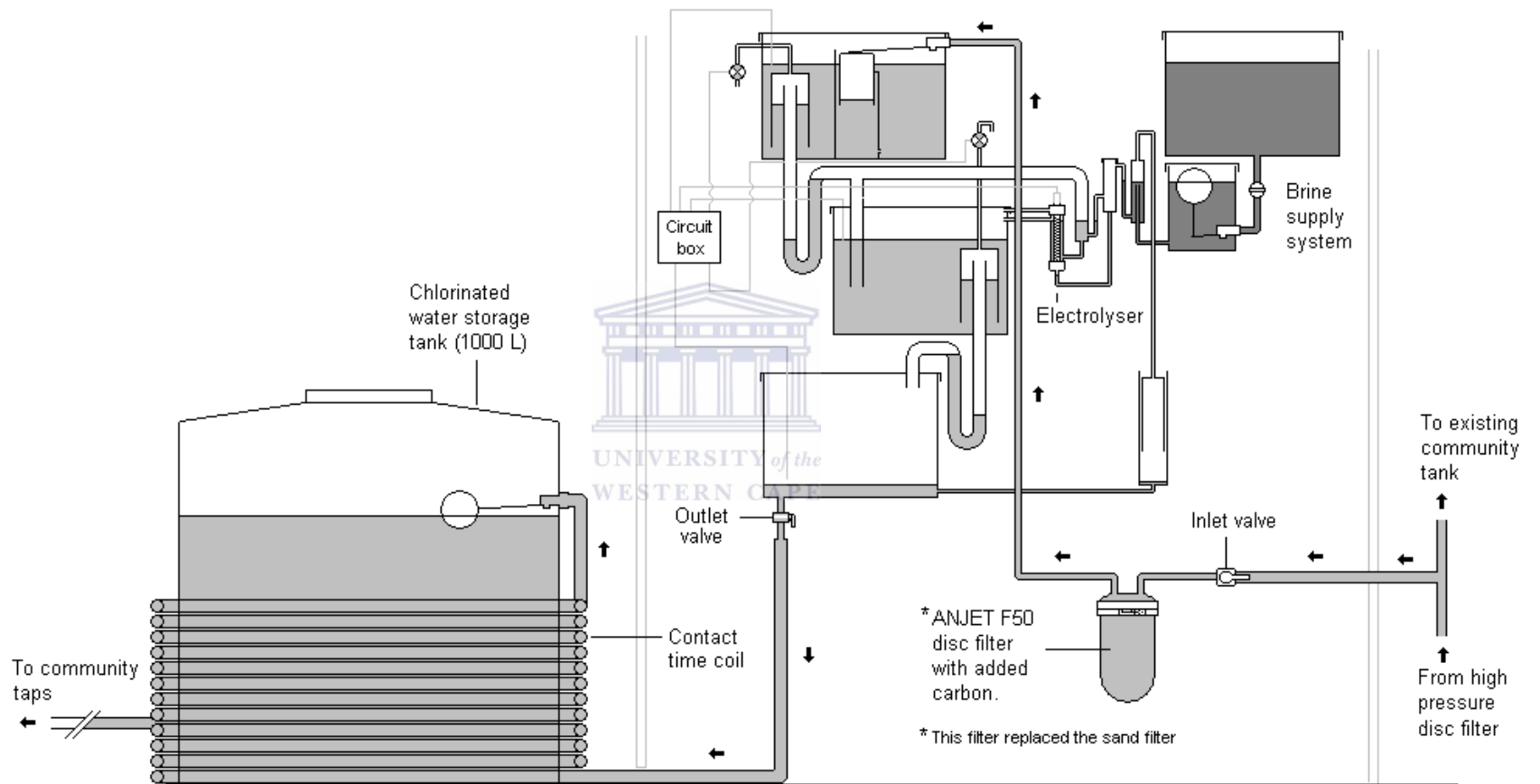

Fig. 7.7 Schematic layout of the disinfection system

7.2.4 Power supply

Three 55 W solar panels were fixed to the roof of the shed to power the disinfection system and the remote monitoring equipment. The panels were linked to a regulator (load max. 10 A) and a 12 V deep cycle battery, which fed a 300 W inverter with a 220 V AC output. The battery, regulator and inverter were housed inside a lockable security cage inside the shed.

7.2.5 Electrical equipment and remote monitoring

The electrical equipment housed in the shed, in addition to the power supply, included the circuit box, SSE® remote monitoring box (for current monitoring of the electrolyser), and a 3-6 V AC to DC adjustable power supply for the electrolyser (Fig. 7.8).

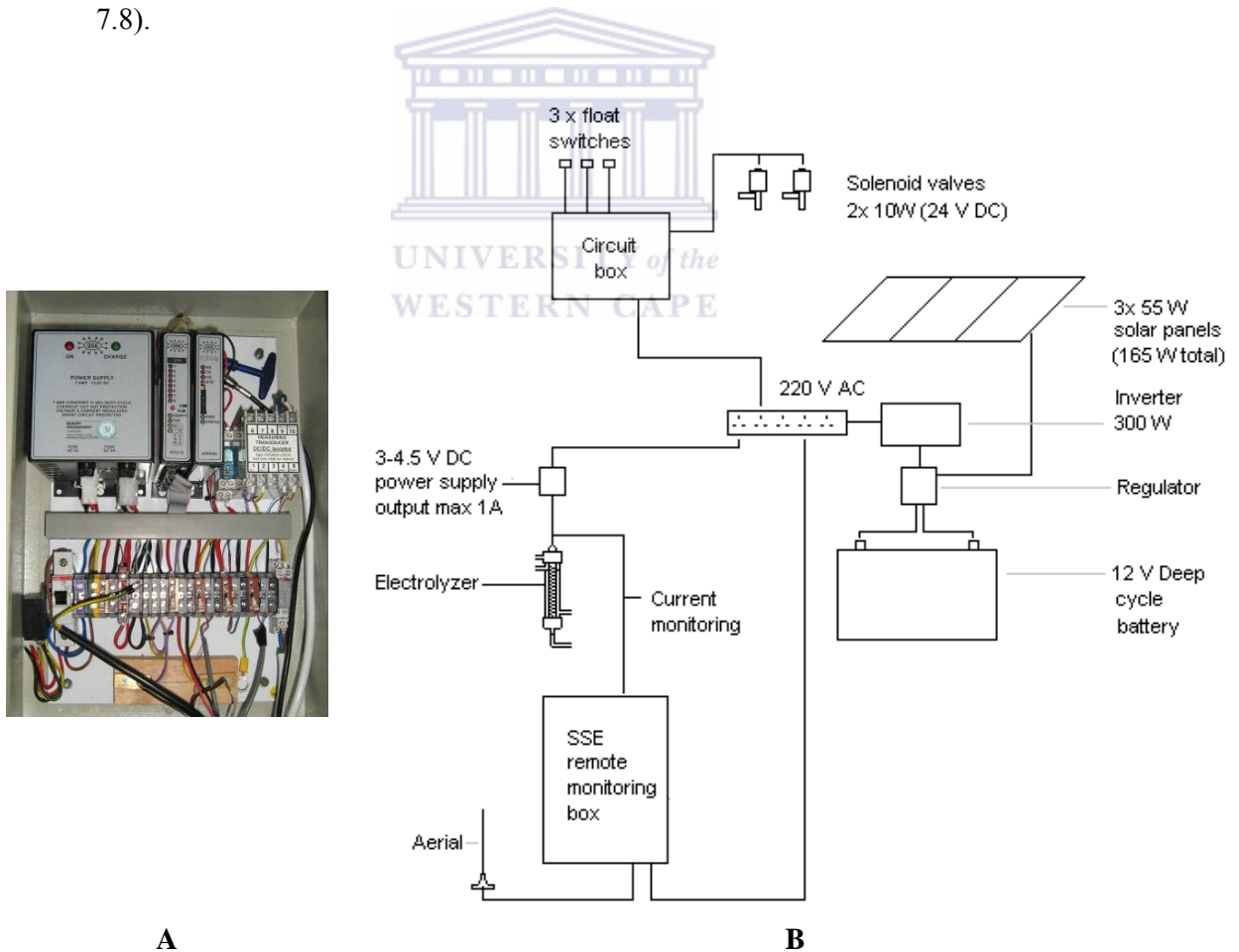

Fig. 7.8. Electrical equipment. A: SSE® remote monitoring box. B: Schematic of components

7.3 CONSIDERATION OF THE EXISTING WATER QUALITY

At the beginning of May 2008 the water from the irrigation pipeline had low turbidity of less than ~5 FNU, and was low pH (pH 6-6.5), which was a promising prospect for both chlorination and brine electrolysis. WEWUSA also kindly provided a printout of water analysis conducted at the irrigation pump station inlet on the Breede River. The data covered the months of February and March that same year (Table 7.2).

TABLE 7.2 WATER QUALITY SUPPLIED TO THE FARMLAND IRRIGATION SYSTEM		
Sampling location: Breede River, Worcester East pump station. Sampling date: February to March 2008. (Data supplied by WEWUSA)		
	6, 19 th February and 19 th March 2008	SANS 241 drinking water: plant operational limit
Microbiological (CFU/100 mL)		
<i>Escherichia coli</i>	19, 3, 4	0
Faecal coliform bacteria	25, 14, 4	—
Total coliforms	300	—
Faecal streptococci	18	—
Physical and organoleptic		
Conductivity at 25°C (Ms/m)	6.3, 7.6, 7	<150
Total dissolved solids (mg/L)	50	<1000
pH at 25°C (pH units)	6.81, 6.56, 6.69	<5.0-9.5
Turbidity (NTU)	20.3	≤1
Chemical (mg/L)		
Ammonia as N	<0.15, 0.46, 0.17	<1
Calcium as Ca	2, 2.5, 2.4	<150
Chloride as Cl	14.6, 49.2, 12.4	<200
Fluoride as F	<0.10, <0.10, <0.10	<1
Magnesium as Mg	2.4, 2.2, 1.3	<70
Nitrate and nitrite as N	<0.2, 0.27, 0.2	<10
Potassium as K	1.2, 1.0	<50
Sodium as Na	7.5, 8.3	<200
Sulphate as SO ₄	5.0, <4.0, 4	<400
Zinc as Zn	<0.012	<5
Chemical micro-determinants (µg/L)		
Aluminium as Al	850, 220, 880	≤300
Antimony as Sb	<10.0	<10
Arsenic as As	<10.0	<10
Cadmium as Cd	<1.0	<5
Total Chromium as Cr	20.0	<100
Cobalt as Co	<7.0	<500
Copper as Cu	<22.0	<1000
Cyanide (recoverable) as Cn	<5.0	50
Iron as Fe	840, 300, 400	≤200
Lead as Pb	<20.0	<20
Manganese as Mn	<40.0	<100
Mercury as Hg	≤10.0	≤1
Nickel as Ni	<8.0	<150
Selenium as Se	<10.0	<20
Vanadium as V	<50.0	<200
Chemical organic-determinants (mg/L)		
Dissolved organic carbon as C	1.6	<10
Additional samples (mg/L)		
Chemical oxygen demand	<8.0, 32.9, 12.0	—
Ortho phosphorus as phosphorus P	0.6, 0.3, 1.0	—
Organochlorides	non detectable	—
Organophosphates	non detectable	—
Boron as B	<0.10	—
Soap, oil and grease	<1.0	—
Total suspended solids	23	—
Grey highlighted = exceeds the SANS 241 drinking water limit for plant operation		

The turbidity of the water at the site, < 5 FNU (on May 2008), was considerably less than that of the water described in Table 5.2, 20.3 NTU (or FNU), that had been tested two months earlier. This suggested that either the water quality in the river had dramatically improved over two months and/or that the high pressure sand filters in the irrigation system network and the pre-existing disc filters on the farm had collectively removed at least 90% of the turbidity.

7.4 ESTABLISHING THE DISINFECTION SYSTEM AND REMOTE MONITORING

7.4.1 Determination of chlorine demand and filling the storage tank

The chlorine demand of the water needed to be determined before the system could be operated. This was done by letting water into the system and allowing the electrolyser to run and dose the water on a 4 V, eight-min batch cycle (as established in Chapter 5). The chlorine (FAC) concentration of the water was measured immediately after the dose and then again after a 30 min standing period to determine the chlorine demand.

Using a 2.0-2.5 mg/L dose, the chlorine demand was found to be ~0.5-1.0 mg/L after 30 min to obtain a residual of 1.0-1.5 mg/L. The water was ~pH 5.5-6 (acidic) and ~4.5 FNU (low turbidity). To achieve the above dose, the electrolyser's brine supply needed adjusting to deliver ~10 mL of brine at 25 g/L.

After establishing the chlorine dose requirement, the disinfection system was allowed to fill up the 1,000 L storage tank. Owing to the position of the storage tank and the inclusion of the float valve, the maximum water volume in the tank was only 850 L. The filling of the tank from empty took ~5 hrs. Once full, the chlorine residual in the tank water was measured and found to be ~0.1 mg/L. The loss of residual in the tank probably did not result from malfunction of the electrolyser, owing to the maintenance of stable current readings (~0.3-0.45 A) throughout the procedure. The loss probably reflects the demand of the tank itself and the dilution effect of mixing incoming water

with standing water over the 5 h period. Regardless of the cause it was reasoned that this problem could be overcome by increasing the chlorine dose accordingly.

7.4.2 Maintaining an acceptable chlorine residual in the storage tank

This procedure was more difficult than expected. The initial goal was to ensure that a residual between 0.2 and 0.5 mg/L could be maintained at the tap. However, this would be highly dependent on the level of consumption at the tap. For example, a starting residual of 0.2 mg/L in the tank was completely depleted at both the tap and the tank after 48 h of no water consumption.

Considering that as an optional water source the consumption levels could be highly variable from day to day and thus input of volumes of chlorinated water to the tank would vary accordingly, this was a difficult problem to solve. It was decided that the tank should receive much higher doses of chlorine to ensure the water leaving the system was disinfected prior to its dilution in the larger volume of the tank. Therefore, unless consumption was very high, an overdose of chlorine in the tank was not possible. At the time of this decision the chlorine dose was increased to ~4.5 mg/L to ensure its disinfection prior to dilution. This corresponded to a 15 mL brine dose to the electrolyser ran at 4 V for 15 min. The outcome of this method was that an increase in consumption would be accompanied by an increase in chlorine residual.

7.4.3 Current monitoring

Having established the disinfection system with a dosing regime, a system for managing remote monitoring was developed. In order to simulate water use, an arrangement with a community member was made to run water from the road tap on a daily basis during the farm's lunch period. The water was fed via a pipe into the vegetable garden (Fig. 7.7 B) and the tap was closed when the community member heard the flushing of the dosing system inside the shed. This allowed the response of the disinfection system to water demand to be monitored remotely from the UWC laboratory, by recording the electrolyser's activity as a current reading. Table 7.3 shows the current readings obtained for a two-week operation of this procedure.

Day	1	2	3	4	5	6	7	8	9	10	11	12		
Current peak	0.48	0.51	0.55	0.46	-	0.58	0.6	0.55	-	-	0.61	0.52	0.58	-
Current resting	0.03	0.01	0.02	0.02	0.01	0.01	0.02	0.01	0.0	0.01	0.01	0.03	0.0	0.0

Days 3 and 5 the system flushed two batches (i.e. 60 L).
Days 4, 7, 8 and 12 the operator was unavailable.

Table 7.3 above shows that the system reliably responded to the level drop of water in the storage tank. Current peaks caused by electrolyser activity corresponded to times of water consumption and maintained a reliable level over the two-week period. The resting current corresponding to the presence of water in the electrolyser remained low in periods no activity. It was concluded that the system had worked successfully and its activity could be monitored remotely.

7.5 CONSIDERATION OF THE COMMUNITY

Community participation and acceptance of the study was essential for it to commence. In order to learn about the community and understand their feelings toward their existing water supply and their feelings toward the project, a baseline household survey was designed to gather the following information:

- Average household population and age distribution of the community.
- Nature of the existing household water supply system and the community's feelings toward it.
- Recent health history (incidence of diarrhoea).
- Community knowledge and understanding of water chlorination.
- Community feelings towards the project and willingness to participate and use the chlorinated water from the disinfection system.

7.5.1 Approach

One adult member from each household was interviewed using the baseline survey questionnaire (see Appendix 1) and was explained the purpose and intentions of the study. The survey was conducted on Saturday 12.07.2008 between 12:00 and 14:00. This date and time was determined as most suitable, since most community members would be present (the survey coincided with a televised Springbok Rugby match). The survey included the presentation of a glass of water from the disinfection system, and a demonstration that the chlorinated water was safe to drink.

7.5.2 Summary of findings from questionnaire

- *Average household population:*

3 Adults

3 Children

Total community population = ~110 people

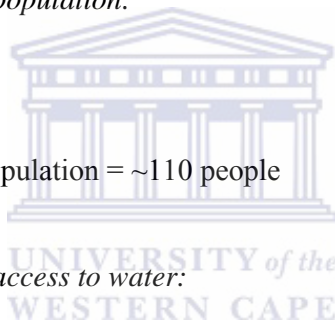

- *Average household access to water:*

4 taps

1 toilet

1 shower

1 kitchen sink

1 bathroom sink

- *Pre-existing water source:*

3 overhead asbestos (2,000 L) tanks shared between the 18 households, 6 households per tank on average.

- *Feelings towards the pre-existing water quantity and quality:*

Quantity:

All interviewed were happy with the quantity.

Quality:

Observations of abnormality were described by 3 households. These participants mentioned that in summer and autumn the water appearance was brown or murky; tastes muddy even brackish; and has a slight musty smell. In winter, the water was reported as being clear and colourless but with frequent mud specks; tastes sweet; and has no smell. The participants were concerned about the summer quality of the water and mentioned that they boiled their water during this period.

- *Recent health history (incidence of diarrhoea):*

Two households reported single incidences of diarrhoea (one adult woman and one 5 year old boy) both within the last two years, but did not suspect the water and attributed the cause to something they may have eaten.

- *Knowledge of water chlorination:*

More than 50% of the participants were not aware that municipal water contains chlorine and smells slightly of “Jik”. The role of chlorination in water disinfection was also largely unknown by the participants.

- *Willingness to drink the chlorinated water:*

All participants were prepared to taste the chlorinated water and most could detect the smell of “Jik” when asked. Some participants detected that the water had a different taste. One participant mentioned that the addition of chlorine to the water seemed strange owing to their familiarity with bleach (Jik®) as a cleaning product.

- *Willingness to use the communal chlorinated water tap:*

The majority of participants said they would be prepared to try using the water from the roadside tap. Some participants mentioned that the tap was too far from their houses, but might try it if they were thirsty walking by.

- *Opinion of the disinfection system:*

No participants raised objections, and all those interviewed understood that the disinfection system represented an optional source of drinking water. Some considered the system interesting but were not sure whether it was a necessity. In general more concern was expressed about the muddy state of the water in summer and one participant asked if the system would fix the problem.

7.5.3 Discussion and major conclusions from the baseline survey

Information gathered from the baseline survey and site assessment resulted in the following major conclusions concerning the project's commencement:

- *The disinfection system should supply an optional drinking water source:*

Owing to the well established household plumbing (toilets, taps, sinks etc.) at the site, the water consumption rate by the community (estimated at a minimum of 10 kL/day), would exceed that of the disinfection system's output, which as a prototype was established to provide a maximum of ~5 kL/day. Therefore, it was concluded that for the scope of this study, the disinfection system would best serve as an optional source of chlorinated water that could be used for drinking, food preparation and limited bathroom use (e.g. brushing teeth).

- *The water at the site requires both chlorination and pre-treatment:*

The mention of changes in the existing water quality (discoloration, smell, taste etc.) during summer indicates that water disinfection is required at the site, and that ideally the entire water supply to the households should be chlorinated and undergo a more efficient pretreatment stage. The appropriate level and method of pre-treatment would be determined during the course of the project. Case history of diarrhoea was minimal suggesting that even if there was microbial contamination of the water it had not seriously affected the community. However, the continual expansion of Worcester's lower income housing settlements upstream of the WEWUSA pump station may cause the water quality to deteriorate in the near future.

- *Boiling of drinking water reveals community concern*

The fact that the community boils their drinking water in summer shows awareness of the threat of potential illness from water.

- *A community operator for the disinfection system was available and willing to participate:*

During the installation of the disinfection system various members of the community had voluntarily helped in its construction and testing during the lunch periods on the farm. One member of the community showed particular interest and participated in the remote monitoring of current experiments (section 7.4.3 and 7.6). During this period, this member became the elected community operator for the disinfection system and gained a good understanding of how it worked and needed to be maintained. The location of the system (being on a daily used route (near the road) and within 100 m of the elected operator's house) also made it readily accessible to the operator.

- *Households furthest from the tap might not use the roadside tap:*

The distance of the roadside tap from the furthest houses in the community was more than 100 m. Such households were unlikely to readily carry water over this distance given that they already have taps in their houses. Therefore, if the disinfection system was to prove successful more taps and increased pipeline length might be required to make the water more accessible.

- *Community response permitted commencement of the study:*

No objections towards the disinfection system were raised by the interviewed participants, and all interviewed proved willing to drink the chlorinated water. Therefore, it was concluded that the system could be made accessible for use by the community.

7.6 CONTINUOUS OPERATION OF THE DISINFECTION SYSTEM

Having established the disinfection system and potential support of the community to use the water, the disinfection system could be left to run at the site under the supervision of the community operator. During a continuous, uninterrupted, two-month period from the start of July to the end of August 2008, the disinfection system was monitored remotely and checked on weekly visits by the project team.

The following parameters were monitored:

- Electrolyser current (daily remote monitoring from UWC).
- Water use (via indication of electrolyser current activity).
- Chlorine (FAC) concentration, turbidity and pH (during weekly visits).

On each weekly visit an additional test batch was run, and chlorine concentration, turbidity and pH were measured directly from the freshly dosed batch in the dosing tank. Chlorine concentration was also measured in the storage tank and at the road side tap on each weekly visit (results are presented in section 7.6.2 below).

7.6.1 Role of the community operator

During the two month period the community operator was accessible by cell phone communication and had access to the disinfection system for checking the brine supply. The operator was also given instructions for how to shut down the disinfection system if a problem was detected via remote monitoring at UWC. This was achievable by the operator simply closing the inlet tap to the disinfection system (Fig. 7.7).

7.6.2 Results of continuous operation

The results obtained from both remote monitoring of current (RM current readings from batches) and weekly visits to the site are presented in Table 7.4. The batch number represents the number of times the electrolyser was activated by community use of the

tap, and indicates the point at which more than 30 L had been drawn from the storage tank.

TABLE 7.4 RESULTS OF CONTINUOUS OPERATION

July 2008

Total amount of water drawn from tank ~60 L (or 2 batches)

	Week 1	Week 2	Week 3	Week 4
No. of batches	1	1	0	0
<u>RM Current reading</u>				
Batch 1	0.48 A	0.51 A		
<u>Weekly visit</u>				
Chlorine residual in tank	0.1 mg/L	0.0 mg/L	0.0 mg/L	0.0 mg/L
Chlorine residual at the road tap	0.1 mg/L	0.0 mg/L	0.0 mg/L	0.0 mg/L
Chlorine conc. test of dose	4.6 mg/L	3.8 mg/L	4.2 mg/L	4.3 mg/L
Turbidity	3.5 FNU	5.6 FNU	4.9 FNU	5.2 FNU
pH	6.3	6.7	6.3	6.1

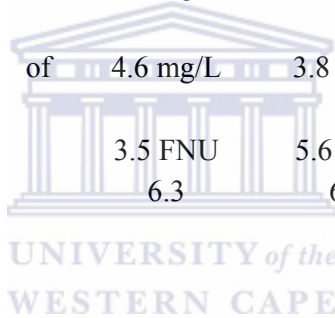

TABLE 7.4 RESULTS OF CONTINUOUS OPERATION (continued)

August 2008

Total amount of water drawn from tank ~90 L (or 3 batches)

	Week 3	Week 4	Week 3	Week 4
No. of batches	1	0	1	1
<u>RM Current reading</u>				
Batch 1	0.54 A		0.51 A	0.56 A
<u>Weekly visit</u>		No visit		No visit
Chlorine residual in tank	0.0 mg/L		0.0 mg/L	
Chlorine residual at the road tap	0.0 mg/L		0.0 mg/L	
Chlorine conc. test of dose	4.7 mg/L		4.9 mg/L	
Turbidity	4.7 FNU		4.9 FNU	
pH	6.5		6.1	

Total amount drawn from July and August > 150 L

7.6.3 Discussion and conclusions from the continuous running period

- *The disinfection system proved reliable:*

The results from the continuous running period (Table 7.4) show that the system operated in a reliable manner owing to consistent current yields from the electrolyser and consistent chlorine doses at the dosing tank. During this period the inlet water had minimal fluctuation in turbidity and pH.

- *Limited use of water and loss of chlorine residual in the storage tank:*

The total use of water over the two month period amounted to less than one batch (30 L) per week, or 150 L in total over two months. Consequently, the corresponding rate of incoming chlorinated water to the storage tank was insufficient to maintain a desired chlorine residual of 0.1-0.5 mg/L of water. The water entering the storage tank did however receive sufficient chlorine contact time (20 minutes at ~4-5 mg/L) for disinfection to occur prior to its dilution in the 1000 L tank (see section 5.4 concerning chlorine demand).

- *Probable factors behind the limited use of the water:*

Two factors probably account for the limited use of the water by the community. Firstly, the water supply to the household taps during the test period (i.e. winter) was of low turbidity and perceivably good quality. Secondly, the distance and inconvenience of having to collect water from the roadside tap was likely weighed against the first factor by the community.

- *More taps could help maintain a higher chlorine residual in the storage tank:*

Given that prolonged standing time of water in the storage tank reduced its chlorine residual, easier access to the water (which might result in higher consumption) could increase the chlorine residual in the storage tank. Therefore, installation of taps in the yards of the community households could provide a future answer to this problem (see section 7.8.2).

7.7 PROBLEMS ARISING FROM INCREASED TURBIDITY

Fluctuations in the turbidity of the water supply began in September 2008. The water became increasingly more turbid through spring, and by late summer (February to the end of April 2009) it had risen to 120 FNU. Communication with WEWUSA revealed that the phenomenon was caused by the release of water from the Brandvlei Dam into the Breede River, which is done to increase the water level in the river to maintain pumping of irrigation water to the farm network.

7.7.1 Adjustments to the filtration system

The sand filter (Fig. 7.6 A) installed in the shed failed to remove the increased turbidity of the water. There was also concern that the intermittent nature of the water flow (i.e. as 30 L batches) through the filter disturbed its optimal function. Furthermore, the filter proved difficult to clean because of insufficient backpressure for backwashing the sand (thorough washing of the sand by hand would have proved extremely inconvenient on a regular basis). Therefore, the sand filter was replaced by an easily cleanable disc filter (the ANJET F50) with a 115 micron filtration pore size (Fig. 7.9 and Fig. 7.7). The filter canister provided a convenient housing to include granular carbon in the form of graphite or charcoal chips for removing odours and unwanted chemical contaminants in the water. The filter could be easily dismantled *in-situ* via a spring clip mechanism and the discs loosened for cleaning.



Fig. 7.9 The ANJET F50 disc filter that replaced the sand filter.

Fig. 7.9 shows the disassembled filter in two parts: the left hand side part contains the disc stack which fits into the casing on its right hand side. Water enters the casing from the right hand side pipe and then passes through the channels in the disc to leave via the left hand side pipe.

UNIVERSITY of the
WESTERN CAPE

7.7.2 Effects of turbidity increase on the operation of the disinfection system

While the disc filter had made filter cleaning easier it did not improve the removal of the turbidity from the water. Consequently, the high turbidity of the water made chlorination unsuitable due to following reasons:

- (i) The masking effect of high turbidity (i.e. > 10 FNU) on disinfection.
- (ii) The increased risk of toxic THM formation from the organic content of the turbidity.
- (iii) Turbidity at 120 FNU also directly affected the function of the electrolyser, causing current to drop by ~ 0.1 A through blockage of the ceramic membrane. The effect was detected via the remote monitoring system, and the disinfection system was subsequently shut down by the community operator following a phone call from the project team at UWC. The effect of high

turbidity on the electrolyser was confirmed by tests conducted at the UWC laboratory (Chapter 4). The tests also found that membrane function could be restored by washing in clean water.

Owing to the above reasons, the disinfection system had to be shut down during the summer and autumn periods of high turbidity.

7.7.3 Impact of the summer and autumn shutdown of the disinfection system

The shutdown was particularly unfortunate because during this period the community was likely to drink more water due to the heat and be inconvenienced by having to boil their household water. Collection of water from the disinfection system would have offered an easier alternative. Furthermore, this period contains the autumn fruit harvest on the farm where an additional 100 part-time workers are employed: hence the inclusion of the orchard tap by the project team (Fig. 7.4 B). The community operator conveyed that the community had voiced their disappointment that the system had been shut down, and that he had explained to them that turbidity had caused the problem.

In conclusion, there was a clear need for a more effective form of pre-treatment at the site, which would permit chlorination and provide drinking water when it is most needed. This was beyond the means and scope of the pilot study but has been listed as a recommendation point for future action. This in itself represents a much needed future project, i.e. a small-scale water clarification system that could operate inline with the disinfection system for surface water treatment (see section 7.8.2).

7.8 FUTURE OF THE DISINFECTION SYSTEM AND THE PILOT SITE

Considering a successful operation period had been achieved, and that the site proved ideal (regarding its locality, potential for community involvement, and requirement for water treatment), both the site and the disinfection system had potential for further use and development. In particular, the following areas of development needed to be carried out to establish the viability of the disinfection system:

7.8.1 Facilitating future community management of the disinfection system

For the system's future viability it must be manageable purely by the community. Furthermore, the high cost of remote monitoring equipment was only appropriate for experimental work and tests. Therefore, the following adaptations were considered for future community management:

- Inclusion of a small voltage control box with current and voltage displays. This would allow the performance of the electrolyser to be viewed on site.
- A detailed user's manual for maintenance and emergency protocol should be compiled.
- Inclusion of an inexpensive chlorine measurement kit that could be used by the community or by an appropriate local authority.
- A contactable local authority that also has knowledge of the system in case the designated community operator is unavailable. WEWUSA are ideal candidates and have a constant presence in the farmland community.
- Ability to acquire spare parts and replacement components.
- A method and schedule for cleaning the cathode. The need for cleaning the cathode did not arise at the site during the pilot study but might in time, and certainly could at sites that have hard water.

7.8.2 Required modifications at the site

Upon the completion of this report the pilot site needed two urgent modifications for optimal use and operation of the disinfection system. These were:

- The installation of an appropriate pre-treatment method for removing turbidity to permit disinfection in summer and autumn.
- Extension of the existing chlorinated water pipe to reach the individual yards of the households. This would facilitate access to water and potentially increase the chlorine residual (i.e. by reducing the water's retention time in the tank).

7.9 CONCLUSIONS TO THE PILOT STUDY

The system proved mechanically viable under the test conditions and period of operation. A longer test period was needed (owing to the delays caused by turbidity) to fully establish the system's mechanical durability. This would be possible if turbidity removal and an increase in community water use can be achieved at the site (section 7.8.2).

Potential for the community's acceptance of the system is gleaned from the baseline survey and from the interest and participation of the community operator. The community showed interest in the system and were aware that the water quality in summer posed a health threat and thus boiled their water. Consequently, disappointment was expressed at the summer shutdown of the system. Various adaptations (section 7.8.1) will be required to establish whether the system is viable for community management.

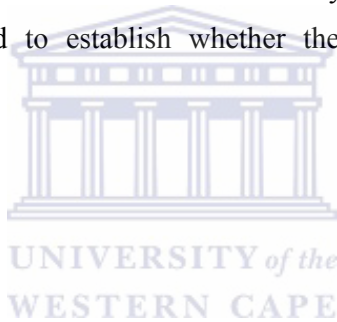

CHAPTER 8

CONCLUSIONS AND RECOMMENDATIONS

8.1 Capacity and cost of the disinfection system

The capacity and costs of the disinfection system are summarised below in Table 8.1. The costs cited are those applicable to the prototype disinfection system and do not include the remote monitoring system or the various additional components that might be required at different sites (e.g. housing, storage tanks, pipeline supply, pre-treatment equipment, etc.).

TABLE 8.1 CAPACITY AND OPERATING CHARACTERISTICS OF THE DISINFECTION SYSTEM		
Membrane electrolyser	Chlorine production:	Maximum: ~20 g/day (24 h)
	Salt consumption:	Maximum: ~70 g/day
	Brine feed concentration:	25 g/L (table salt in water)
	Brine feed rate:	Adjustable 5-15 ml brine batch and adjustable retention time in the electrolyser
	Operating power:	Ave. ~2 W (using 4 V DC)
Disinfection system	Water chlorination capacity:	< 10 kL/day
	Batch disinfection rate:	30 L of water per 5-20 min cycle
	Chlorine dose range:	1-7 mg/L
	Population served:	100-200 people (no less than 25 L/person/day)
	Energy consumption per day:	Maximum: ~55 Wh (electrolyser + batch dosing)
	Maintenance:	< 30 min /week
Capital costs	Electrolyser:	~R 2 000
	10 W Solar power system:	~R 4 000
	Batch dosing system:	~R 3 000
	Total:	<u>~R 9 000</u>
Running costs	Salt (< 2 kg/month):	~R 15/month
	*Operator (2 h/month):	~R 100/month
	Total:	<u>~R 15-115/month</u>
	*Alternatively, maintenance could be managed for free within the community.	

8.2 Cost saving features of the disinfection system

(i) *Exclusion of electrical pumps:*

The control system for the batch dosing system cost ~R1 500 to construct and used ~5 Wh/day; this could be supplied, including the electrolyser, by a 10 W solar panel. In contrast, one small peristaltic pump at ~R1 500 operating at 30 W would run for only 10 min/day at ~5 Wh/day, and would require additional components for its control, i.e. requiring more solar panels at greater expense.

(ii) *Role of the membrane:*

An equivalent sized electrolyser lacking a membrane was found to be $\sim 2 \times$ less energy efficient and $\sim 2 \times$ slower at producing chlorine. Therefore, the membrane saves expense on solar panel requirements i.e. reduces the capital cost of the system. However, the viability of the system does critically depend on the longevity of the membrane and sites that have hard water may not be suitable for its use (see below: section 8.4).

8.3 Basic installation and operating requirements

Installation site requirements:

- Sufficient pipe pressure to supply the inlet pipe of the batch dosing system (at 1.9 m from floor level).
- Water quality of turbidity < 10 FNU.
- Ground level either level with, or higher than, that of the community taps (unless an additional form of pump is used to supply the taps or water is fetched by hand).
- Housing that is weather proof and securely lockable. A minimum 2 m ceiling height is also required and if solar panels are used a position receiving at least 6 h/day of full sun exposure is required.
- Water storage tank(s) (at least 1×1000 L), and reticulation (pipes and taps).

Operation requirements:

- A designated maintenance operator to carry out brine preparation, filling of the brine tank and daily system checking.
- Ability to respond to system failure, i.e. to turn the system off and either instigate a repair protocol or contact a relevant body to do so.
- Ability to purchase salt (the system requires a maximum of ~2 kg/month, see above: Table 8.1, “Running costs”).

8.4. Scope and limitations of the disinfection system

An open pressure system:

The disinfection system doses at atmospheric pressure system and can only produce an open flow of chlorinated water from its outlet at ~1 m above ground level. Therefore, it must be located appropriately for it to supply taps.

Hard water:

It is highly likely that the membrane of the electrolyser will become blocked if used in locations that have extremely hard water. At such sites, the membrane electrolyser could be substituted for an undivided electrolyser (see below).

An undivided electrolyser option

The undivided electrolyser, while less energy efficient than the membrane electrolyser, cost < R1,000 to construct (i.e. at least half the price of the membrane electrolyser) and it is both easier to service and usable at sites with hard water if a regular electrode cleaning protocol is established. However, the chlorination capacity of the system would be approximately halved.

8.5 Conclusions from rural site operation:

- Despite the difficulties experienced with turbidity (section 7.7), the system reliably produced a consistent quantity of chlorine in water during periods of acceptable turbidity of < 10 FNU.
- Community involvement shows promise for future micromanagement of the system.
- The remote monitoring of current proved a reliable system for recording electrolyser activity.

8.6 Overall conclusions and recommendations:

The initial pilot-scale testing of the brine electrolyser and disinfection system appears both cost effective and reliable. However, in view of the problems encountered from turbidity, the recommended future installation sites for the system are presented below:

Recommended water sources:

- Groundwater sources (boreholes and protected well points).
- Clarified surface waters (recommended partnership).
- Treated water requiring chlorine residual boosting.

Recommended future installation sites:

- Farms,
- Schools,
- Clinics and
- Villages.

Recommended operational procedure:

The above sites must be no further than 50 km distance of a trained technician with knowledge of the system. The technician should make monthly visits to the site and

ideally be contactable for problem solving and site management. Therefore very remote rural areas are not suitable unless the above can be satisfied.

Future of the pilot plant in Worcester:

Running of the existing system was limited to winter periods of low turbidity. Therefore, the need for water clarification provides an opportunity for projects in this field, and it is recommended (upon the community's consent) that the pilot plant remains as a venue for continued studies on small-scale water treatment.

Commercialisation

The results suggest that both the electrolyser and dosing system could be suitable candidates for commercialisation either separately or in a combined package. An uninterrupted running time of at least 6 months is needed to fully confirm the consistency of the system and allow the identification of potential any future running problems (see below).

8.7 Recommendations for future research

- The disinfection system should receive at least six months of further testing prior to commercialisation, either at the existing pilot plant (if clarification measures are installed) or at any of the above-mentioned recommended installation sites.
- Collaborative research with an equivalent low cost, low tech, rural water clarification project would form an ideal partnership, which would address the larger problem of surface water treatment. The clarification project could be installed with immediate effect at the existing pilot plant, which would also benefit the community.
- Continued running of the system at the existing site will allow further experience to be gained in community management issues, such as the drafting of running instructions, routines, maintenance and emergency procedures.

REFERENCES

- BASHTAN S.YU, GONCHARUK VV, CHEBOTAREVA RD, BELYAKOV VN AND LINKOV VM (1999) Production of sodium hypochlorite in an electrolyser equipped with a ceramic membrane. *Desalination* 126, (1), 77-82.
- BURCH JD AND THOMAS KE (1998) Water Disinfection for developing countries and potential for solar thermal pasteurization. *Solar Energy*, 64 (1-3): 87-97.
- CARLSSON FHH (2003) *Elementary handbook of water disinfection*. Research Report no. TT 205/03, Water Research Commission, Pretoria, South Africa.
- CDC (2008) Safe water for the community: a guide for establishing a community-based Safe Water System program. Atlanta, GA: US Department of Health and Human Services, CDC; 2008.
http://www.ehproject.org/pdf/ehkm/cdc-safewater_community.pdf
- CHEN T (1967) Spectrophotometric determination of Microquantities of Chlorate, Chlorite, Hypochlorite and Chloride in Perchlorate. *Journal of Analytical Chemistry*, 39, 804.
- DEAT (2008) Access to water in rural areas. State of the environment
<http://soer.deat.gov.za/indicator.aspx?m=620>
- DWAF (2002). *Free Basic Water Implementation Strategy* (August 2002).
<http://www.dwaf.go.za/Documents/FBW/FBWImplementStrategyAug2002.pdf>
- DWAF (2003). *Strategic Framework for Water Services: Water is Life, Sanitation is Dignity*.(September 2003).
<http://www.info.gov.za/view/DownloadFileAction?id=70217>.
- FREESE SD AND NOZAIC DJ (2004) Chlorine is it really so bad and what are the alternatives? *Water Institute of Southern Africa (WISA), Biennial conference*. ISBN No. 1-920-01728-3

- GORDON G, ADAM LC, BUBNIS, BP, KUO C, CUSHING RS AND SAKAJI RH (1997) *Predicting liquid bleach decomposition*. J. AWWA. Vol. 89 issue 4.
- HEBER G (1985) *Simple Methods for the Treatment of Drinking water*. GATE, Vieweg & Sohn.
- HENDERSON AK, SACK RB, AND TOLEDO ER (2005) *A Comparison of Two Systems for Chlorinating Water in Rural Honduras*. J HEALTH POPUL NUTR 2005 Sep; 23(3):275-281 © 2005 ICDDR,B: Centre for Health and Population Research. ISSN 1606-0997.
- HYDES O (1999) European regulations on residual disinfectant. *J. am. Water Works Assoc.* 91 (1): 70-74.
- IRC/WHO (1981) *Small community water supplies. Technology of water supply systems in developing countries*. Technical Paper Series 18, Den Haag Aug 1981.
- KRAFT A, BLASCHKE M, KREYSIG D, SANDT B, SCHODER F AND RENNAU (1999) Electrochemical water disinfection. Part II: Hypochlorite production from potable water, chlorine consumption and the problem of calcareous deposits. *Journal of applied Electrochemistry*. 29: 895-902.
- KRSTAJIC N, NAKI V AND SPASOJEVI M (1991) Hypochlorite production II. Direct electrolysis in a cell divided by an anionic membrane. *Journal of Applied Electrochemistry*. Vol 21, 637-641.
- LINKOV VM (2002) Electromembrane reactors for the desalination and disinfection of aqueous solutions. *Research report no. 964/1/02*, Water Research Commission, Pretoria, South Africa.
- MAIL & GUARDIAN (2007) *Tests reveal cholera in Vaal River*. Apr 03 2007. <http://www.mg.co.za/article/2007-04-03-tests-reveal-cholera-in-vaal-river>
- MAIL & GUARDIAN (2008) *Limpopo cholera cases increase*. Dec 08 2008. <http://www.mg.co.za/article/2008-12-08-limpopo-cholera-cases-increase>

- MAIL & GUARDIAN (2009) *Eastern Cape on the brink of a water crisis*. Jun 12 2009.
<http://www.mg.co.za/article/2009-06-12-eastern-cape-on-the-brink-of-a-water-calamity>
- MOMBA MNB AND BROUCKAERT BM (2005) Guidelines for ensuring sustainable effective disinfection in small water supply systems. TT 249/05 WRC. ISBN No. 177005-321-2. RSA.
- OBI CL, IGUMBOR JO, MOMBA MNB AND SAMIE A (2008) *Interplay of factors involving chlorine dose, turbidity flow capacity and pH on microbial quality of drinking water in small water treatment plants*. Water SA Vol. 34 No. 5 October 2008. ISSN = 0378-4738
- PAULING L (1970) *General Chemistry*. 3rd ed. WH Freeman and Company, San Francisco.
- PEARSON I (2000) *Field Evaluation of Alternative Disinfection Technologies for Rural Water Supply Projects*. Draft Final WRC Report. Project K5/828.
- PLETCHER D (1982) *Industrial Electrochemistry*. Chapman and Hall, ISBN 0 412 16500 7
- SANS 241 (2005) *South African National-Standard Drinking Water*, 6 edn. Standards South Africa. ISBN 0-626-17752-9
- SIGUBA M. (2004) *The Development of Appropriate Brine Electrolysers for Disinfection of Rural Water Supplies*. MSc. dissertation, University of the Western Cape, South Africa
- SKINNER BH (2001) *Chlorinating Small Water Supplies – A review of gravity-powered and water-powered chlorinators*. WELL Study Task 511. WELL Resource Centre Network for Water, Sanitation and Environmental Health. Loughborough University: UK.
- SOLSONA F AND PEARSON I (1995) *Non-conventional Disinfection Technologies for Small Water Systems*. WRC Report No. 449/1/95. ISBN No. 1-86845-197-6

SWARTZ CD (2000) *Guidelines for the Upgrading of Existing Small Water Treatment Plants*. WRC Report No. 783/1/00. ISBN No. 1868-45-5963

WALLACE & TIERNAN OSEC®. (2002) Basic Principles of Electrochlorination: A review of the factors affecting chlorine generation efficiency. *Chemfeed Limited Priory Works Tonbridge, Kent TN11 0QL*

WHITE GC (1999) *Handbook of Chlorination and Alternative Disinfectants*. 4th Edition. John Wiley & Sons

WHO GDWQ (2005) Chlorite and Chlorate in Drinking-water. Background document for development of WHO *Guidelines for Drinking-water Quality*. http://www.who.int/water_sanitation_health/dwq/chemicals/chlorateandchlorite0505.pdf

WRC UK (1984) *Treatment and disinfection of small water supplies* – Final Report 551-S, DWI0080. Water Research Centre (WRC), UK. (Available from Foundation for Water Research, UK. See summary at: (<http://www.fwr.org/waterq/dwi0080.htm>))

WRC: Water Research Commission (2002) *Quality of Domestic Water Supplies. Volume 4: Treatment Guide*. WRC No. TT 181/02. ISBN No. 1-86845-873-3

APPENDIX 1: QUESTIONNAIRE

PART A (Baseline Household Survey)

1. Household Occupants						2. House Water Supply				3. Drinking water				
Adults			Children			No. of taps	No. of toilets	No. of showers	No. of baths	No. of boilers	No. of houses sharing	Source		
Number	Age	m/f	Occupation	Number	Age	m/f	Occupation	Taps	Sink	Toilet	Shower	Bath	Boiler	Comments:
Total number:														

4. Knowledge of current water source

Where it is stored						
Where it comes from						
Water description key: Fine = F; Insufficient = I; Always = A; Often = O; Sometimes = S; Never = N; Very = V; Slightly = sl						
	Spring	Summer	Autumn	Winter	Randomly	All seasons
Quantity						
Clarity (describe) E.g. clear, murky, muddy, milky						
Colour (describe) E.g. none, yellow, orange, brown, grey						
Taste (describe) E.g. normal, sour, bitter, soapy, salty						
Smell (describe) E.g. none, chemical, biological						
Debris (describe) E.g. none, sand, leaves etc.						

5. Health (history of diarrhoea/vomiting)

Adults				
Age	m/f	When (last 1-2 year period)	Duration	Suspected cause (water?)
Children				
Age	m/f	When (last 1-2 year period)	Duration	Suspected cause (water?)

6. Feelings toward current water supply.

Availability (Quantity):
Quality:
Water related facilities (taps, sinks, toilets, shower etc.):
As drinking water:

7. Feelings toward the project and communal drinking tap

- Do you know that municipal treated water (e.g. mains water Worcester and Cape Town) is treated with chlorine?
- Do you know why?
- Did you know that municipal water contains a residual amount of chlorine that has a slight smell of JIK®?
- Do you know why?
- How do you feel about the project providing a communal tap for chlorinated drinking water?
- Would you be happy to drink this water?
- Are you happy with the amount of information you have received about the water project so far?



APPENDIX 2: HYPOCHLORITE AND CHLORINE

Relationship between the oxidation strength of chlorine and sodium hypochlorite

To calculate how much sodium hypochlorite (NaOCl) is required to replace the oxidising power of chlorine gas (Cl₂), the reaction of these species with potassium iodide (KI) in a solution of acetic acid (HAc) reveals the following:

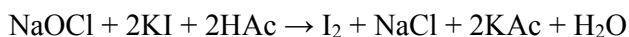

And...

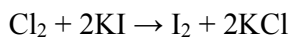

Therefore, one molecule of NaOCl will oxidise the same amount of iodide as one molecule of Cl₂.

Trade terms used to define hypochlorite strength

Grams per litre of available chlorine – This measurement must be determined using an analytical method (e.g. see Appendix 2) and represents the mass of Cl₂ of equivalent oxidising strength (see above).

Grams per litre of sodium hypochlorite – I.e. the mass of NaOCl in one litre. It is calculated from the measurement of available chlorine multiplied by the ratio of their respective molecular masses (NaOCl = 74 g and Cl₂ = 71 g). E.g. 1 g/L Cl₂ × 74/71 = 1.05 g/L NaOCl

Percentage of available chlorine – This is equal to the mass of available chlorine in 100 ml.

E.g. 1 g/L Cl₂ = 0.1% Cl₂ and 0.105% NaOCl.

Weight percent of available chlorine – This is equal to the chlorine concentration (g/L) divided by the specific gravity (actual weight) of one litre multiplied by ten: $\text{Cl}_2 \text{ g/L} / (\text{specific gravity} \times 10)$.

Weight percent of sodium hypochlorite – This is equal to the weight percentage of chlorine multiplied by 1.05.

(For additional information on hypochlorite handling see: <http://www.powellfab.com/>)

